

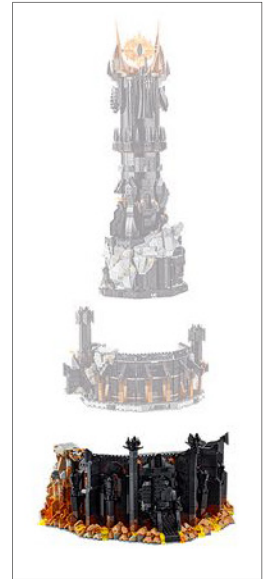

10333



THE LORD OF THE RINGS





LEGO.com/sustainable-packaging



FR
DONNEZ
OU
RECYCLEZ



ASSOCIATION

OU



MAGASIN

OU



DÉCHÈTERIE

Adresses sur quefairedemesdechets.fr



BUILDER



Apple and the Apple logo are trademarks of Apple Inc., registered in the U.S. and other countries and regions. App Store is a service mark of Apple Inc. Google Play and the Google Play logo are trademarks of Google LLC. Tencent and the Tencent logo are trademarks of Tencent Inc.

LEGO.com/devicecheck



LEGO® Builder

„Das ist er! Das Auge.“

- Frodo Beutlin



DER DUNKLE TURM

 In der Trilogie *Der Herr der Ringe* erhalten wir einen ersten Einblick in die Macht von Barad-dûr™, als Frodo Beutlin zufällig den Einen Ring auf seinen Finger steckt. Das Auge der makabren Festung verkörpert den Dunklen Herrscher Sauron™, durchbohrt den schwarzen Himmel von Mordor™ und dringt als Schreckensvision in Frodos Kopf ein. Im Laufe der Jahrhunderte hatte Sauron so sehr an Stärke gewonnen, dass er ganz Mittelerde an sich reißen konnte. Die Macht des Einen Rings sorgte dafür, dass Sauron und somit auch seine Festung unangreifbar blieben, solange der Ring existierte.

Die heldenhaften Hobbits begleiten die Gefährten auf eine zermürende Reise, um den Ring im Herzen von Mordor zu vernichten. Als Samweis Gamdschie Frodo auf dem letzten Stück zu einem Eingang an der Flanke des Schicksalsbergs schleppt, versucht ein verzweifelter Gollum™, die beiden aufzuhalten, und findet letztendlich zusammen mit dem kostbaren Ring im Feuer sein Ende. Barad-dûr, Sauron und seine Armee von Orks werden bei diesem verheerenden Zusammenbruch vernichtet.

Dieses Modell ist dem rätselhaften Monument nachempfunden, bildet bemerkenswerte Details nach und gewährt einen besonderen Einblick in die Ereignisse, die sich hinter den Kulissen von Mordor abgespielt haben.

ANMERKUNGEN DER LEGO® DESIGNGEFÄHRTEN

👁 „Unsere LEGO® Reise nach Mittelerde begann mit einer Reihe von The Lord of the Rings™ und The Hobbit™ Sets, die zwischen 2012 und 2014 herauskamen. Und im Jahr 2023 führten uns die Gefährten mit dem Set 10316 nach Bruchtal. Das ist jetzt das erste Mal, dass wir so tief ins Herz von Mordor™ vordringen, um in das Versteck des Dunklen Herrschers zu blicken. Und zum ersten Mal bringen wir auch Sauron™ als LEGO Minifigur heraus.

Für Fans der Buch- und Filmtrilogie *Der Herr der Ringe* ist Barad-dûr einer der legendärsten Orte in Mittelerde. In den Filmen ist der Turm fast nie in voller Größe zu sehen, und es gibt auch kaum Nahaufnahmen seines Innenlebens. Deshalb haben wir mit verschiedenen Szenen und Ideen herumexperimentiert. Das Modell ist ziemlich groß, weswegen wir es in Segmente aufgeteilt haben, um ein besseres Bauerlebnis zu bieten und das Modell leichter tragen zu können.

Das Modell ist sehr dunkel. Deshalb haben wir farbliche Abstufungen hinzugefügt, um die Illusion zu erzeugen, dass sich Lava spiegeln und das alles sehende Auge Saurons auf der oberen Plattform bewegen würde. Das Modell ist mit diversen Funktionen versehen. Neben aufklappbaren vorderen Toren und einer Drehleiter in der Bibliothek gibt es auch versteckte Räume, überraschende Zubehörelemente und Geheimnisse in dem Dunklen Turm. Hoffentlich werden Fans, die sowohl LEGO Sets als auch *Der Herr der Ringe* lieben, dieses imposante Wahrzeichen von Mordor mit großer Begeisterung erkunden.“

*Antica Bracanov,
LEGO® Senior Model Designer*



*Antica Bracarov,
LEGO® Senior Model Designer*

DIE SCHMIEDE UND DIE VERLIESE

 Dein LEGO® Barad-dûr™ Modell ist in diverse modulare Etagen aufgeteilt. Im Erdgeschoss kannst du den LEGO Stein-Knauf an der linken Seite des Turms drehen, um das Haupttor zu öffnen oder zu schließen und die Schmiede und die Verliese zu betreten. Die traurigen Überreste eines glücklosen Besuchers hängen düster über der flüssigen Lava und warnen ungebetene Gäste vor dem Schicksal, das sie erwartet, sollten sie den Dunklen Herrscher hintergehen.

Nebenan bereiten Orks die bevorstehende Belagerung von Mittel Erde vor. Schilde, Helme, Werkzeuge, Schulterplatten und Speere werden im Fluss des Feuers, der durch die Verliese des Schicksalsbergs fließt, geschmiedet, geschärft und angepasst.

Am anderen Ende des Verlieses versteckt sich Gollum™ in einer kleinen Höhle. In einer geheimen Nische in der Höhle haust eine Riesenspinne. Es ist nicht bekannt, ob Gollum sie dort hineingesteckt hat, damit sie ihm Gesellschaft leistet. Als die Hobbits das Ziel ihrer Reise erreichen, können sich Frodo Beutlin und Samweis Gamdschie nur deshalb unerkannt durch dieses feindliche Gebiet schleichen, weil Gollum selbst die dunkelsten Ecken von Mordor™ wie seine Westentasche kennt.





*"Worauf wartest du denn noch?
Lass ihn einfach los!"*

- Samweis Gamdschie



GOLLUM™



FRODO BEUTLIN



SAMWEIS GAMDSCHIE



ORK

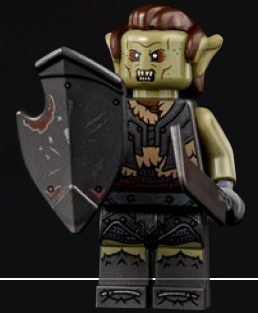

ORK



Frodo Beutlin quält sich durch die unwegsame Landschaft von Mordor™, um den Einen Ring in den im Schicksalsberg lodernen Feuern zu vernichten.

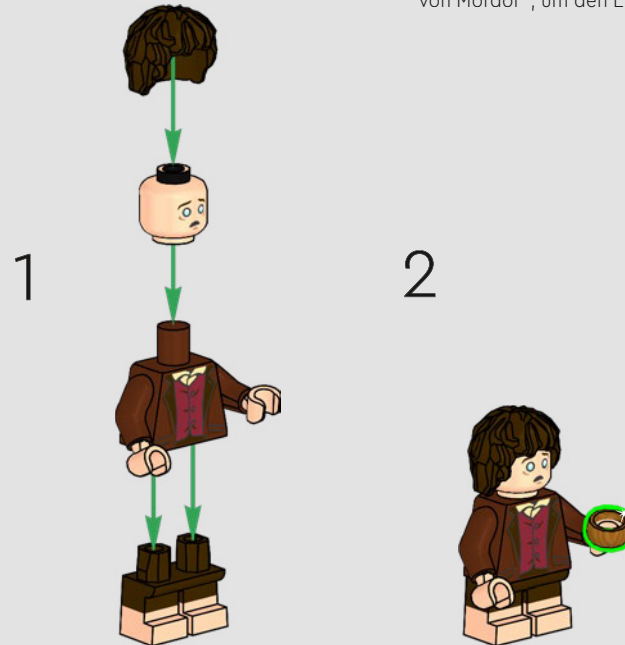
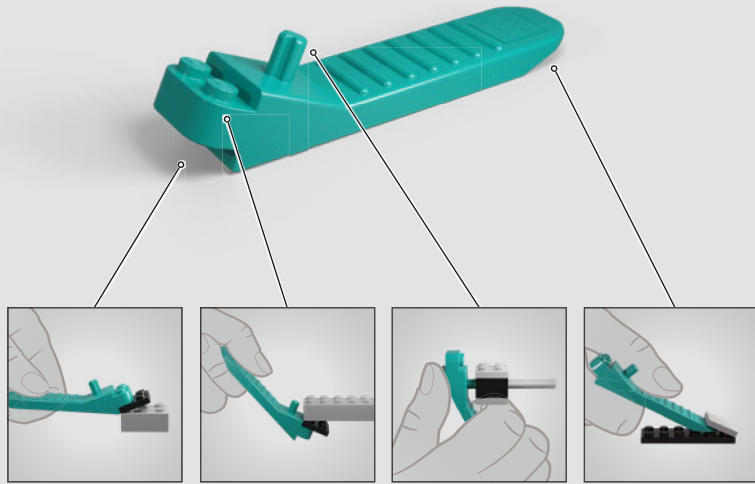

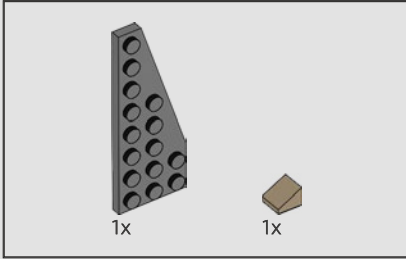
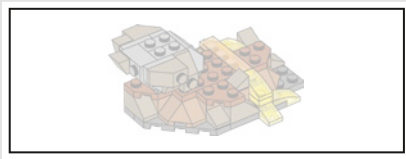

1

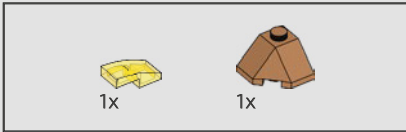
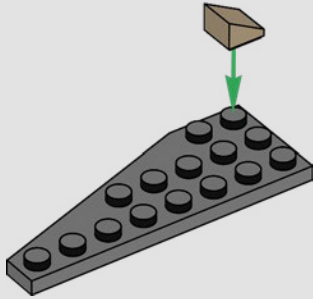

2

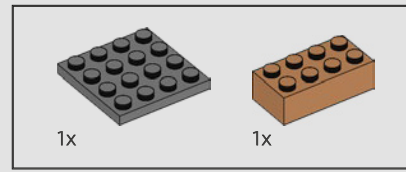
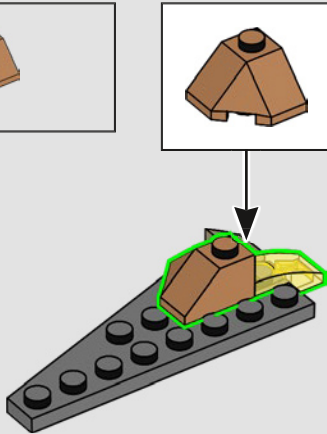

3

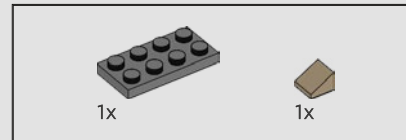
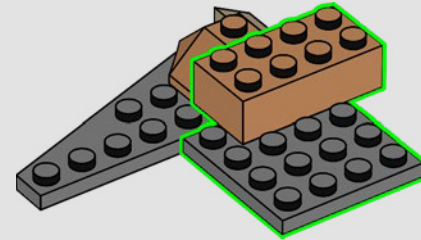

4

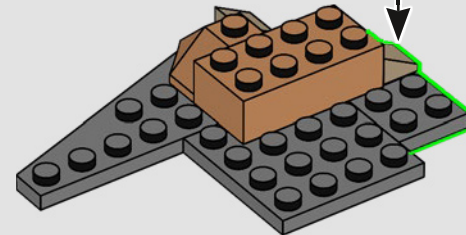
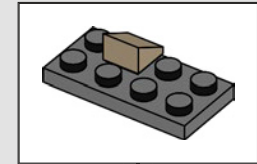

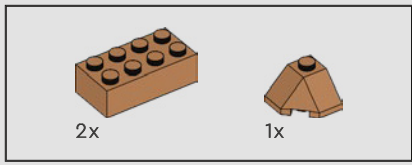

5

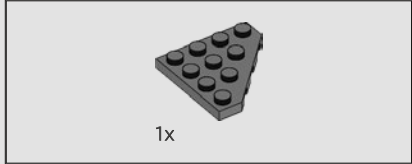
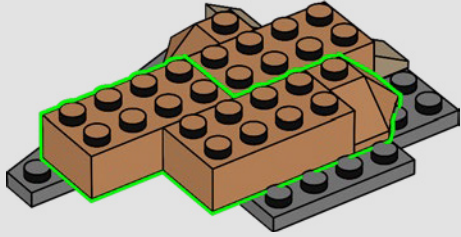

6

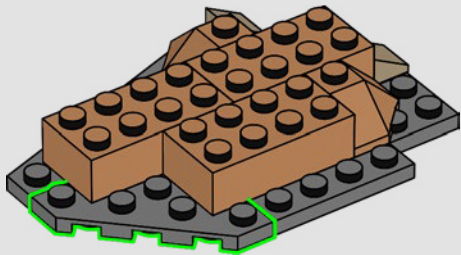

7

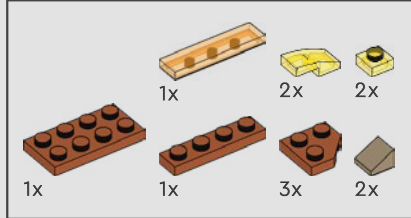
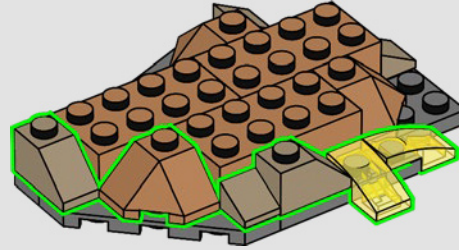

8

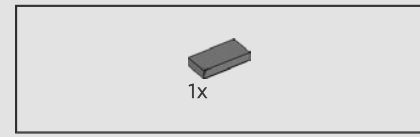
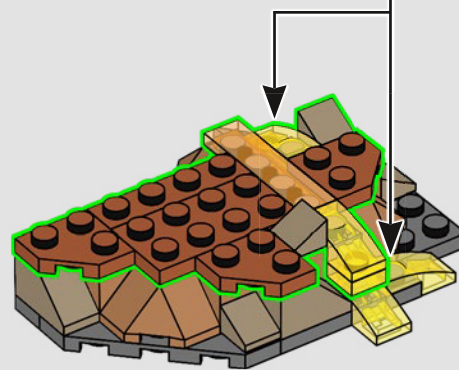
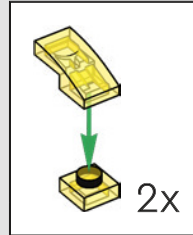

9

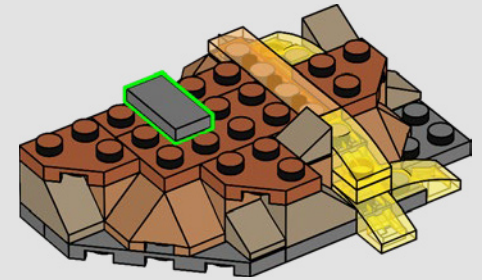

 Das durchsichtig-orange LEGO® 1x4 Steinchen wurde in diesem neuen Farbton eigens für dieses Modell hergestellt. Das Set enthält 63 dieser Teile.



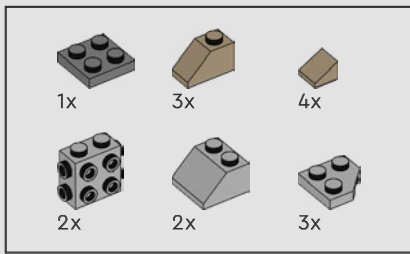

10

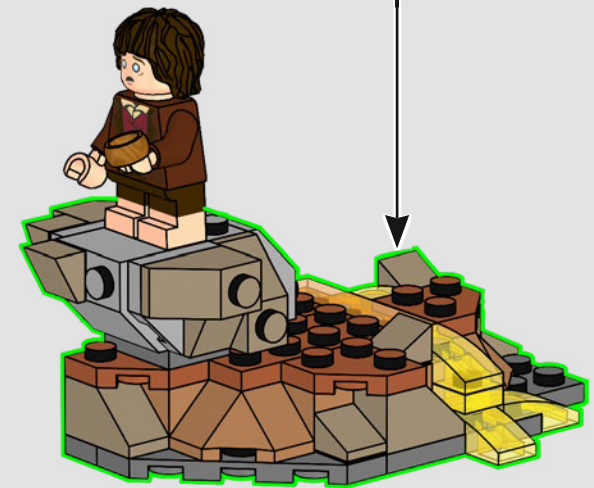
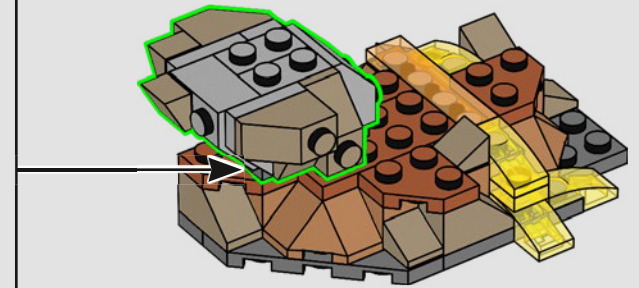
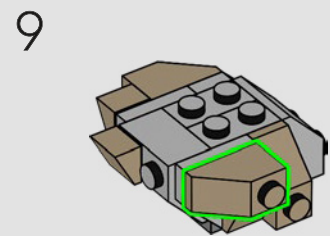
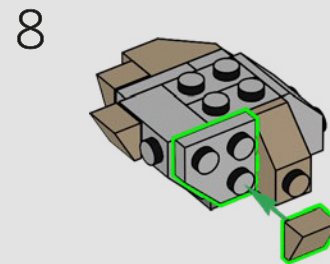
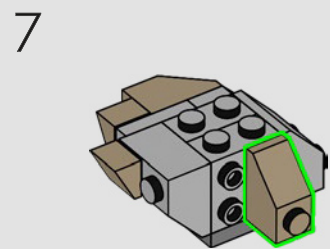
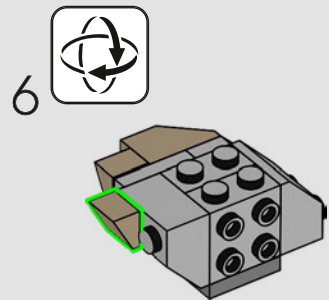
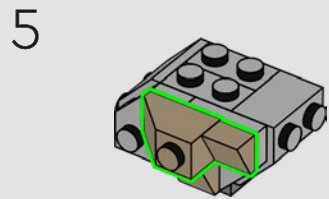
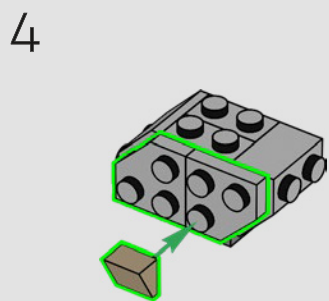
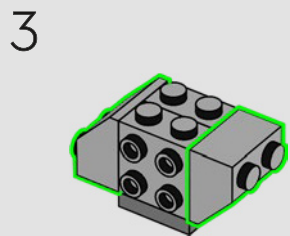
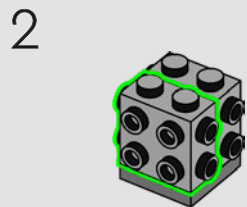
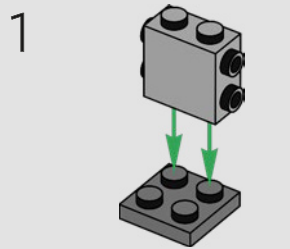

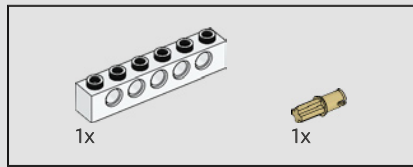
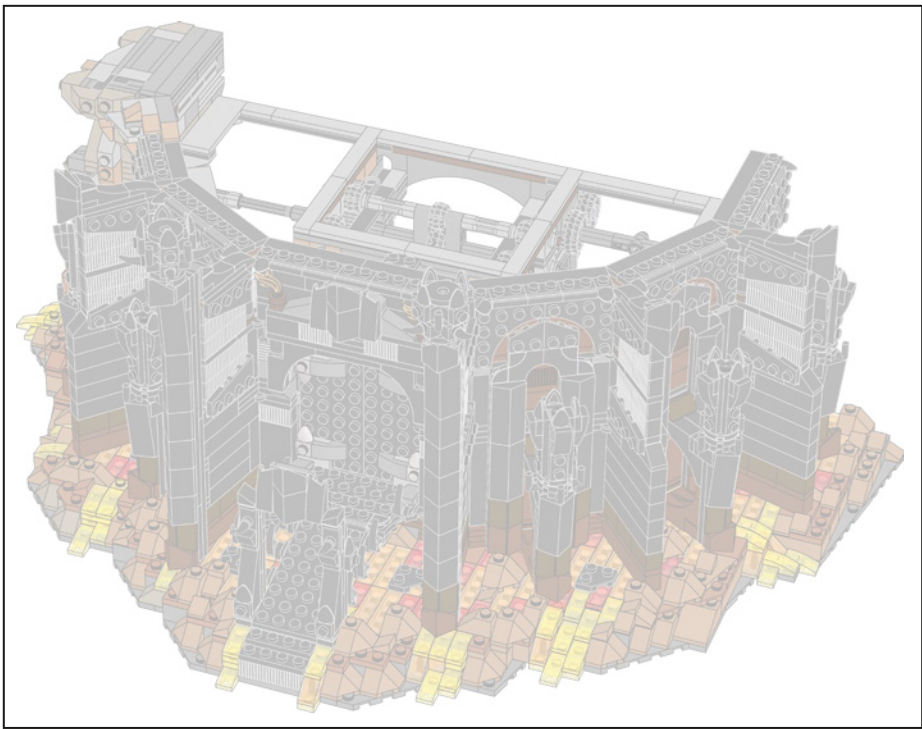

2

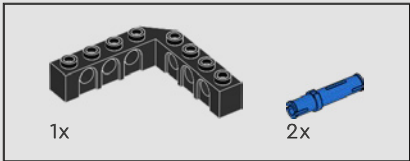
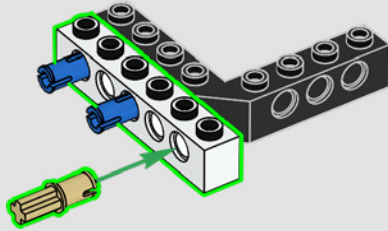

1

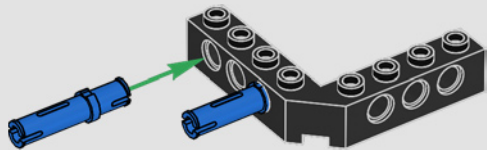

3

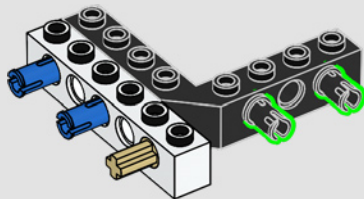

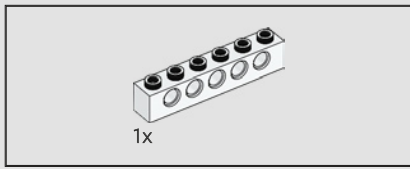

4

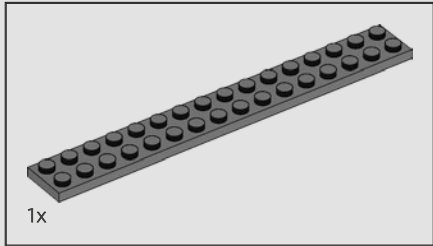
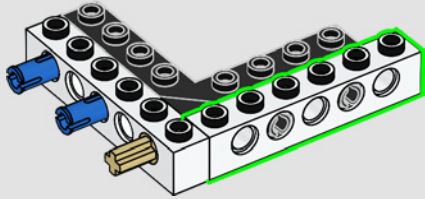

5

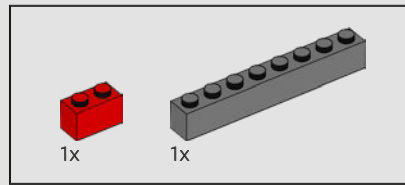
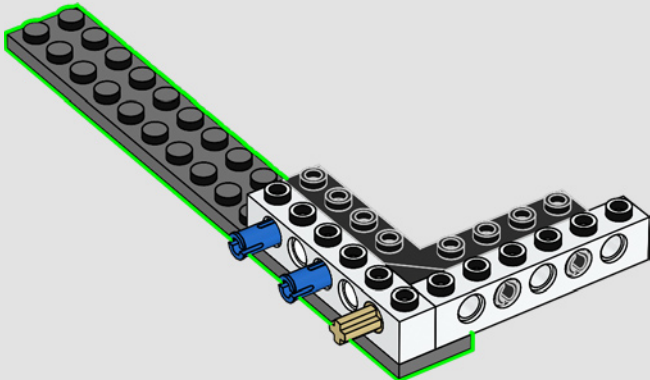

6

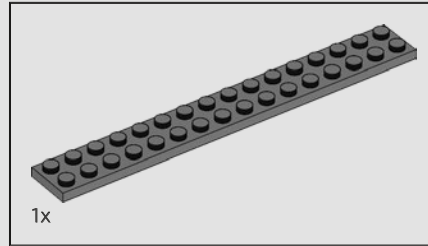
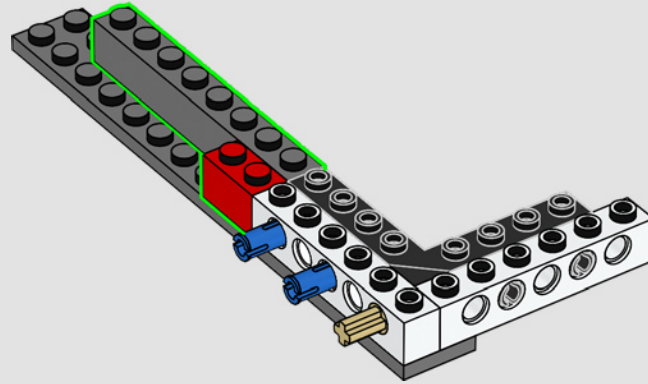

7

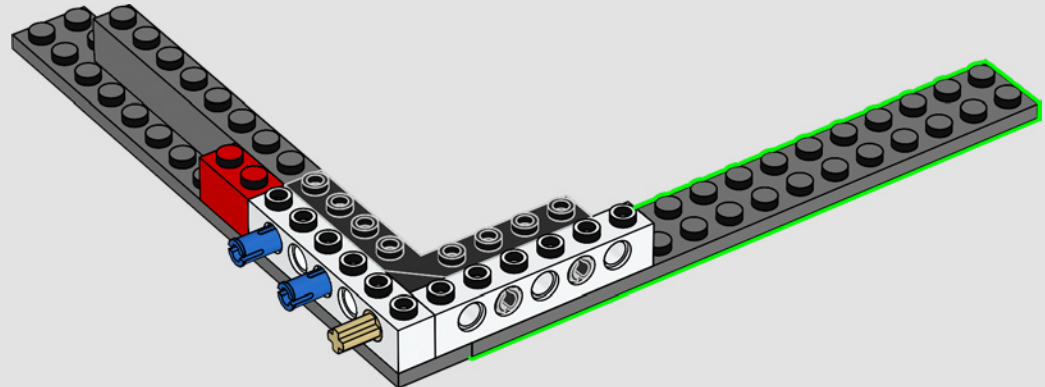

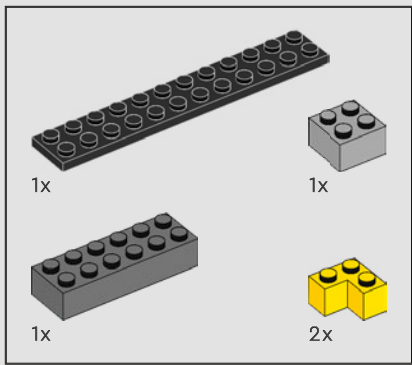

8

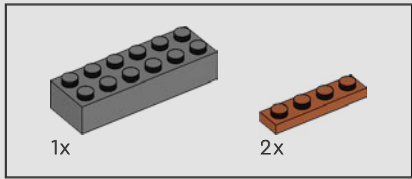
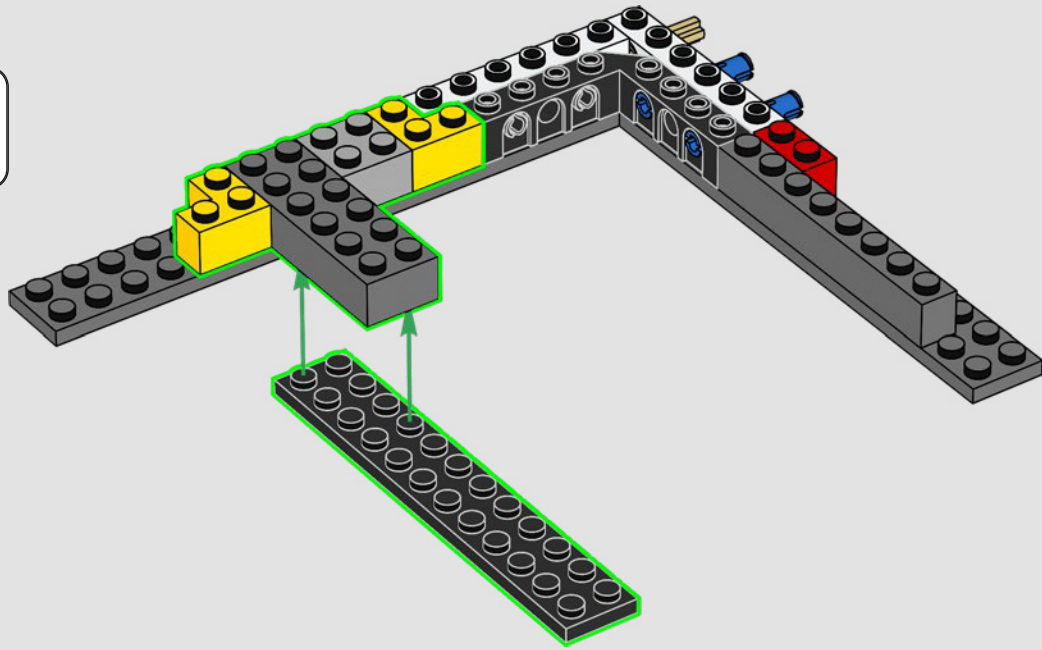

9

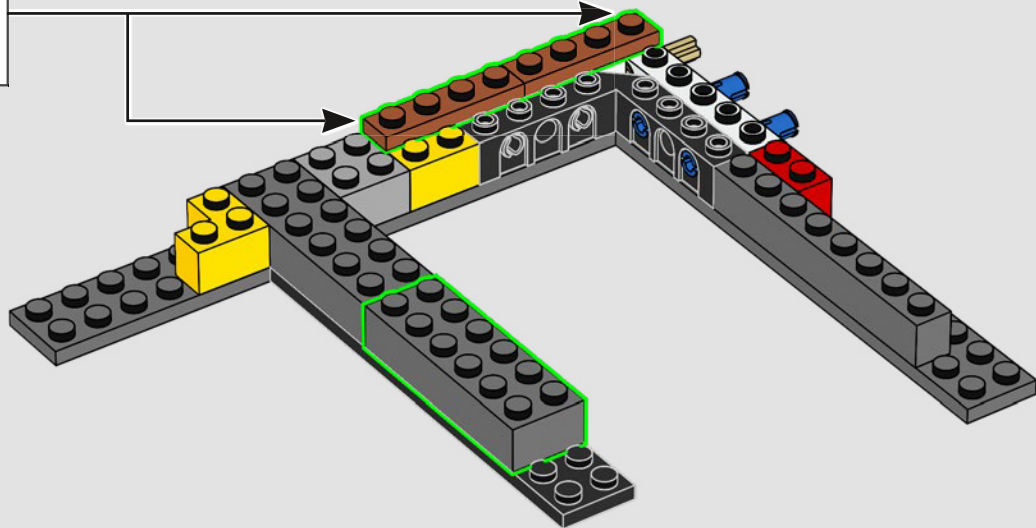
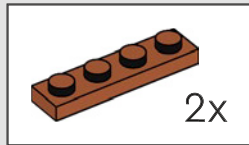

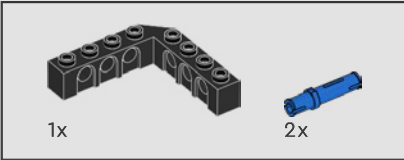
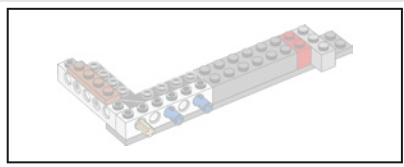

10

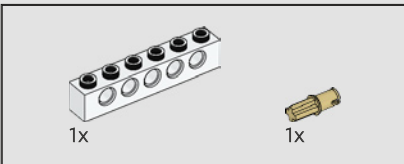
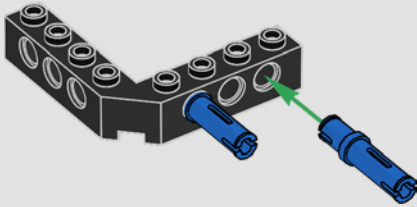

11

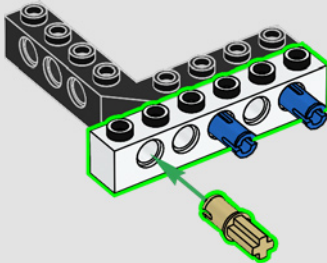

12

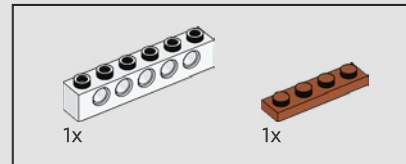
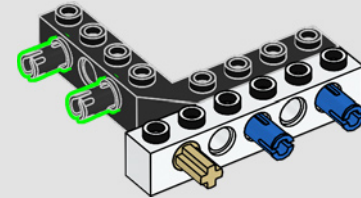

13

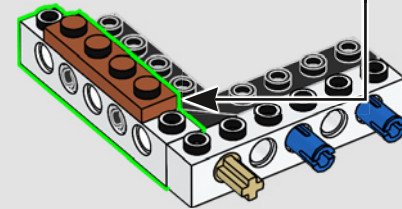
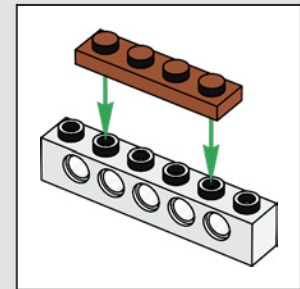

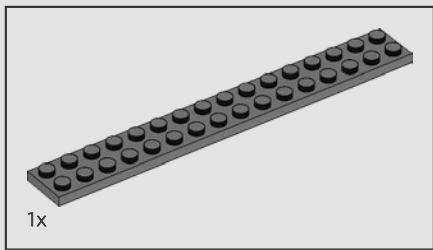

14

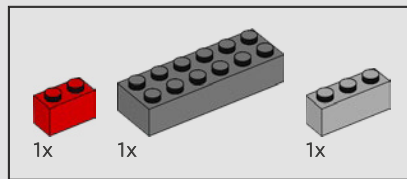
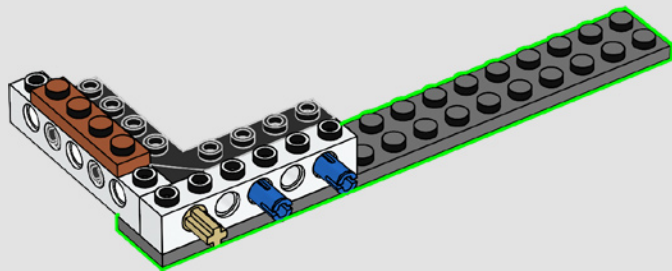

15

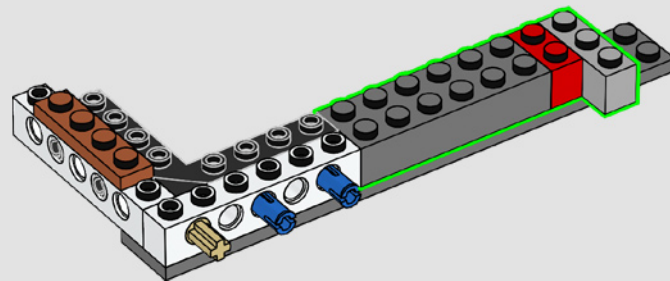

16

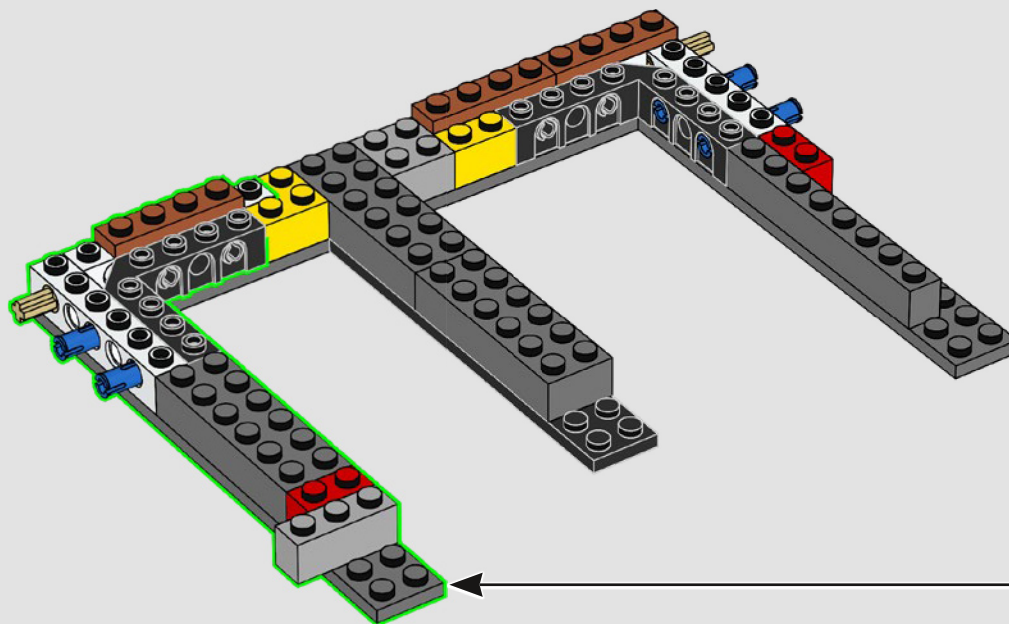

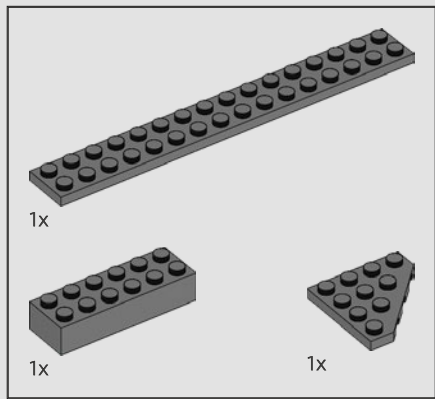

17

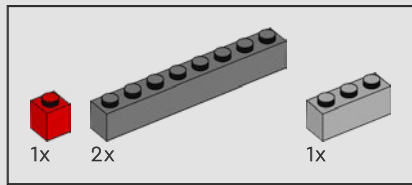
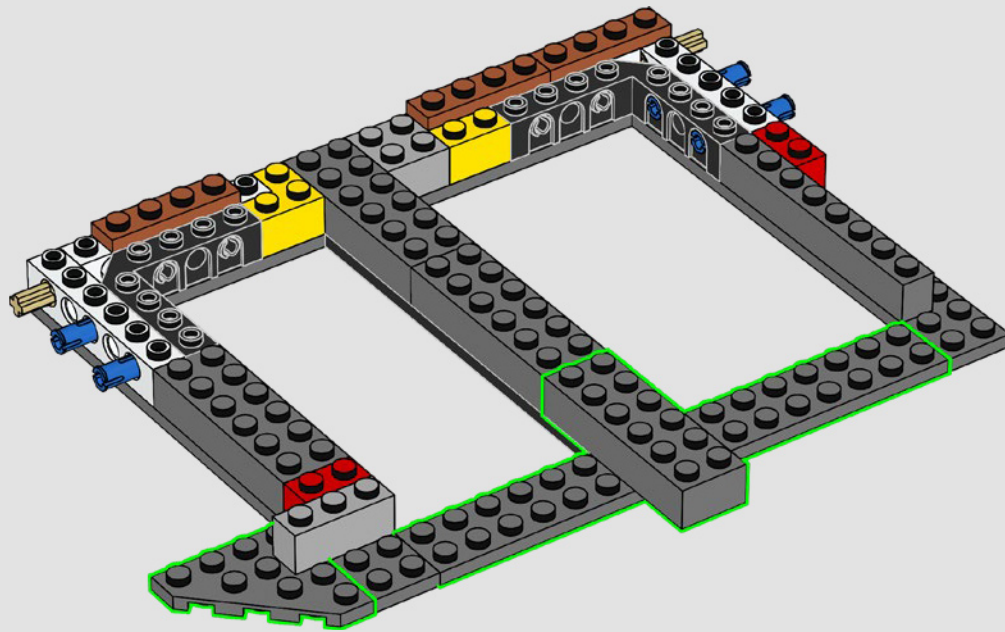

18

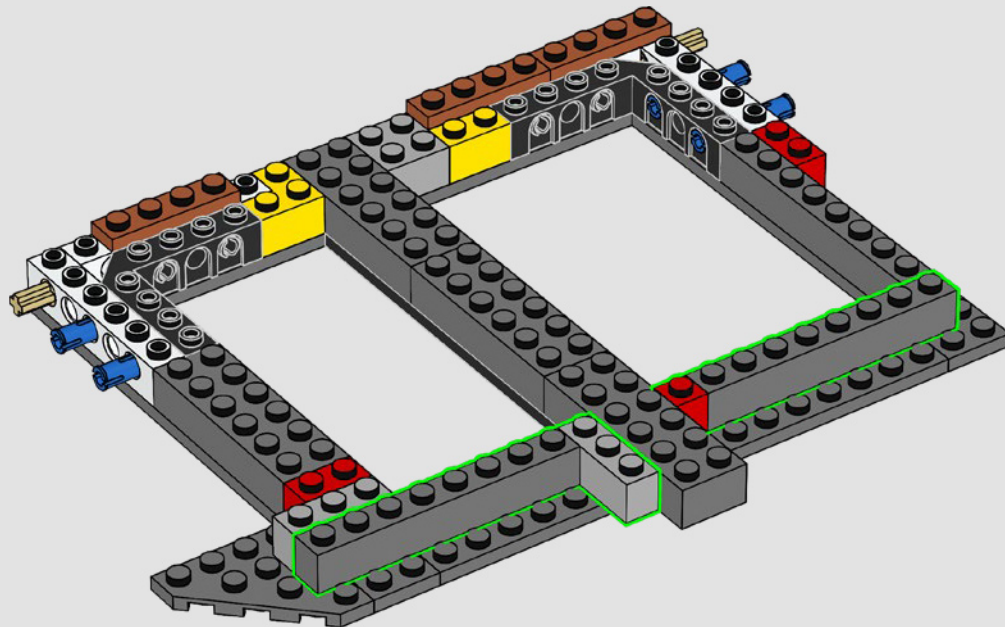

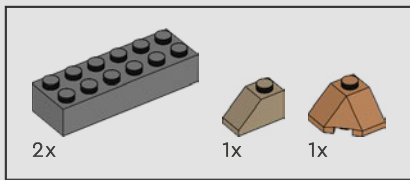

19

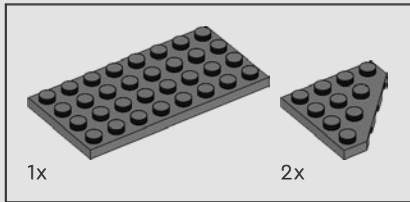
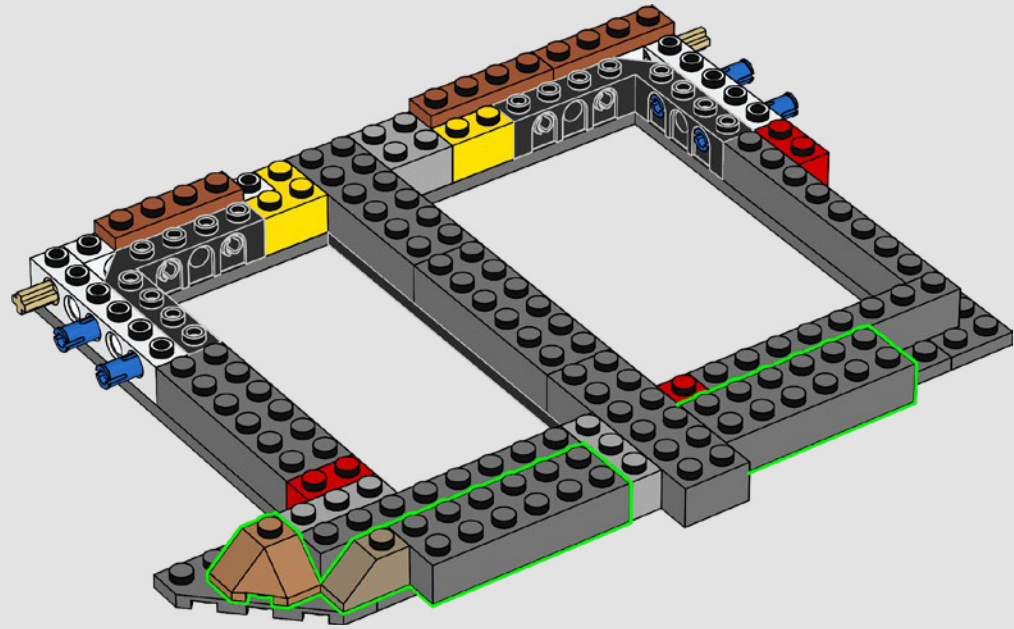

20

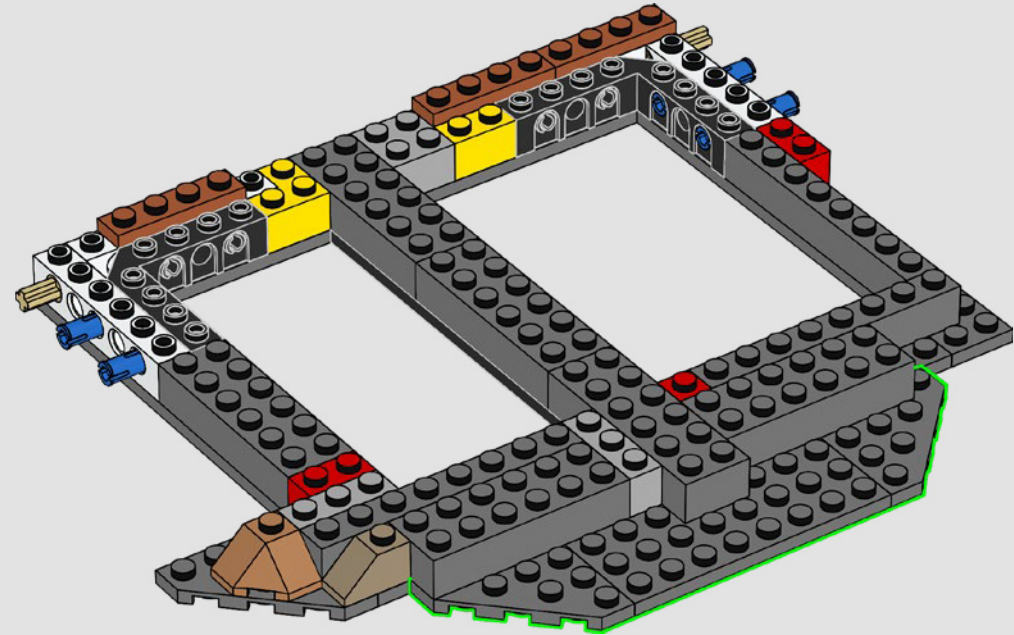

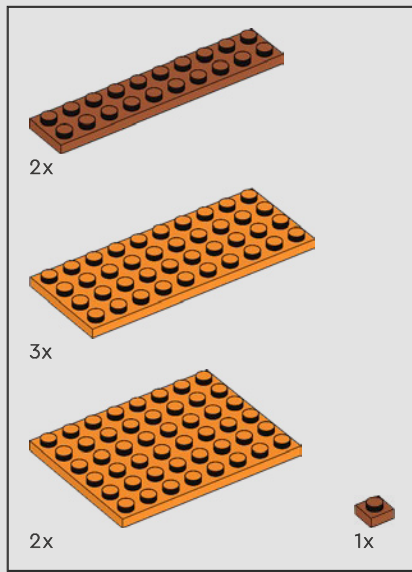

21

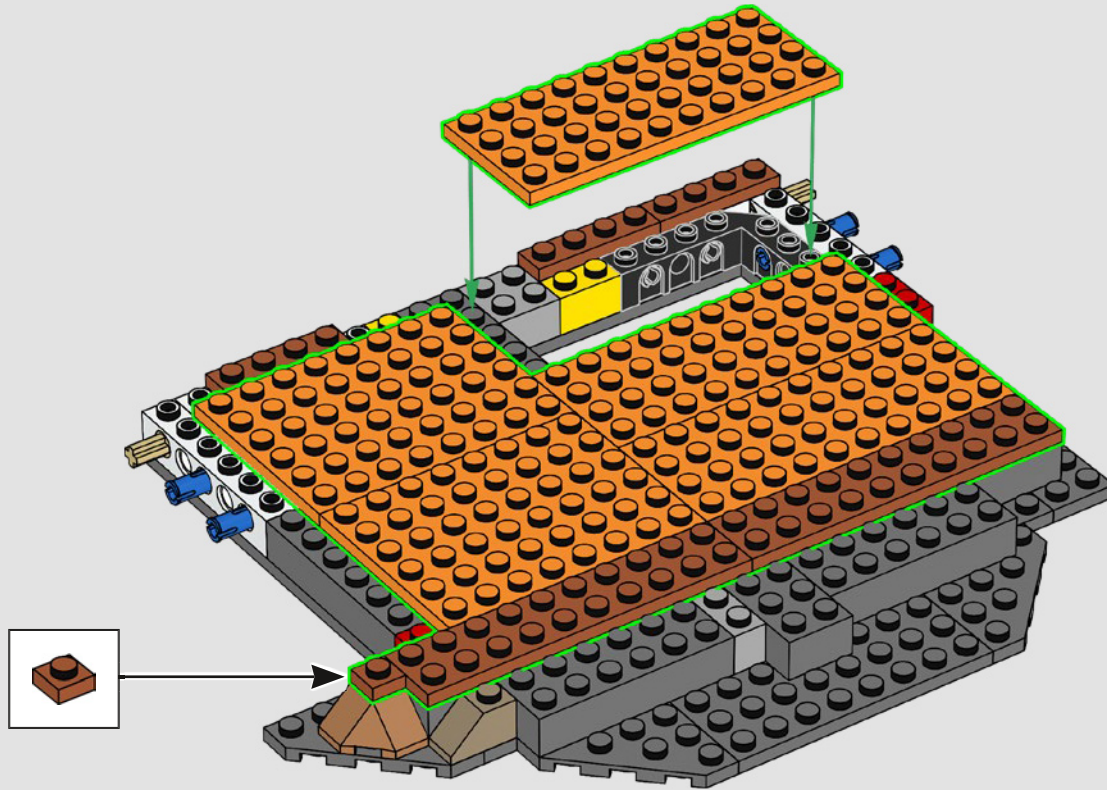

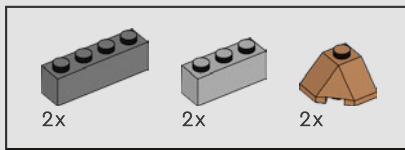

22

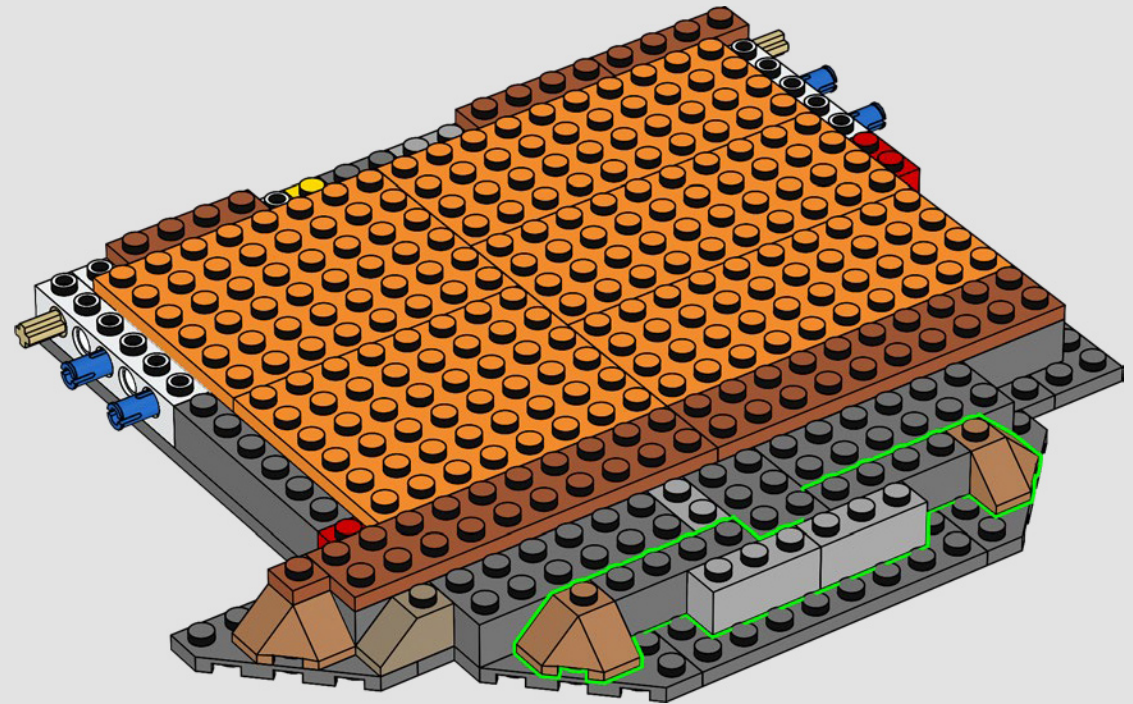

Galadriels Phiole, die Samweis Gamdschie in den Händen hielt, hatte Galadriel ursprünglich Frodo Beutlin geschenkt. Nachdem Frodo die Phiole beim Kampf mit Shelob verloren hatte, besiegte Sam Shelob und holte sich die Phiole zurück.

1

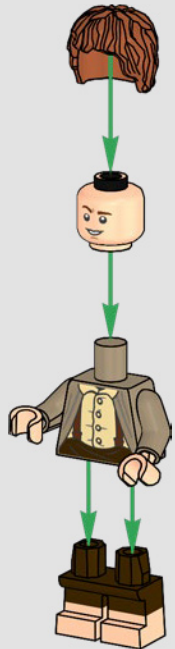

2





23

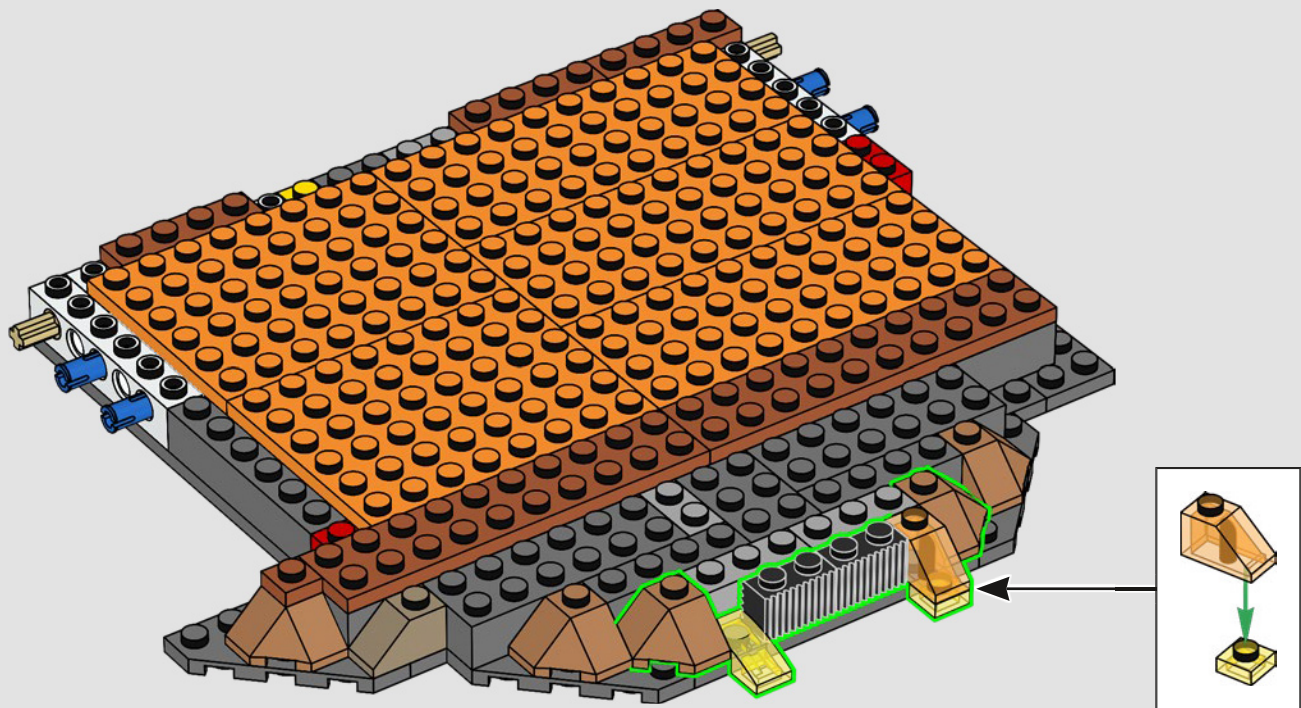

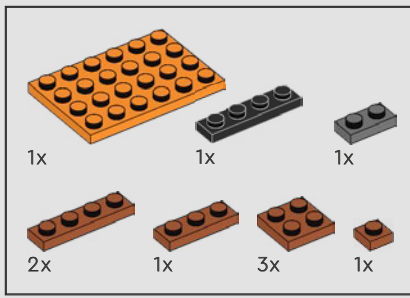

24

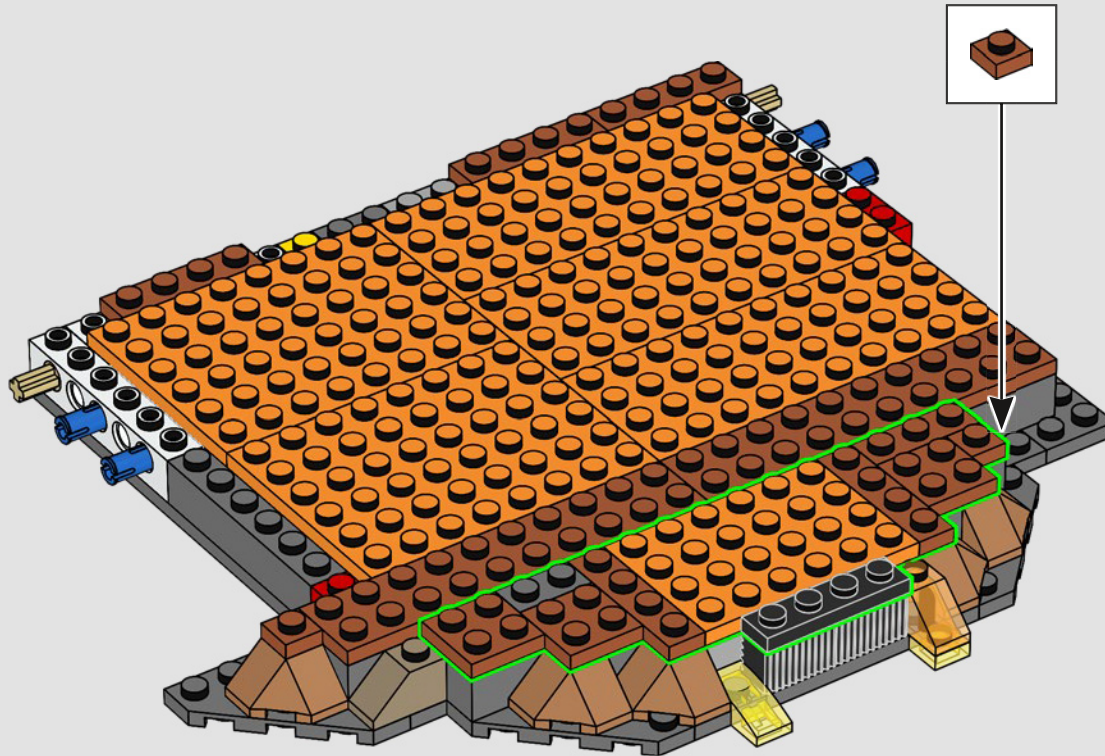

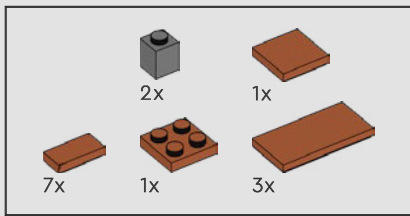

25

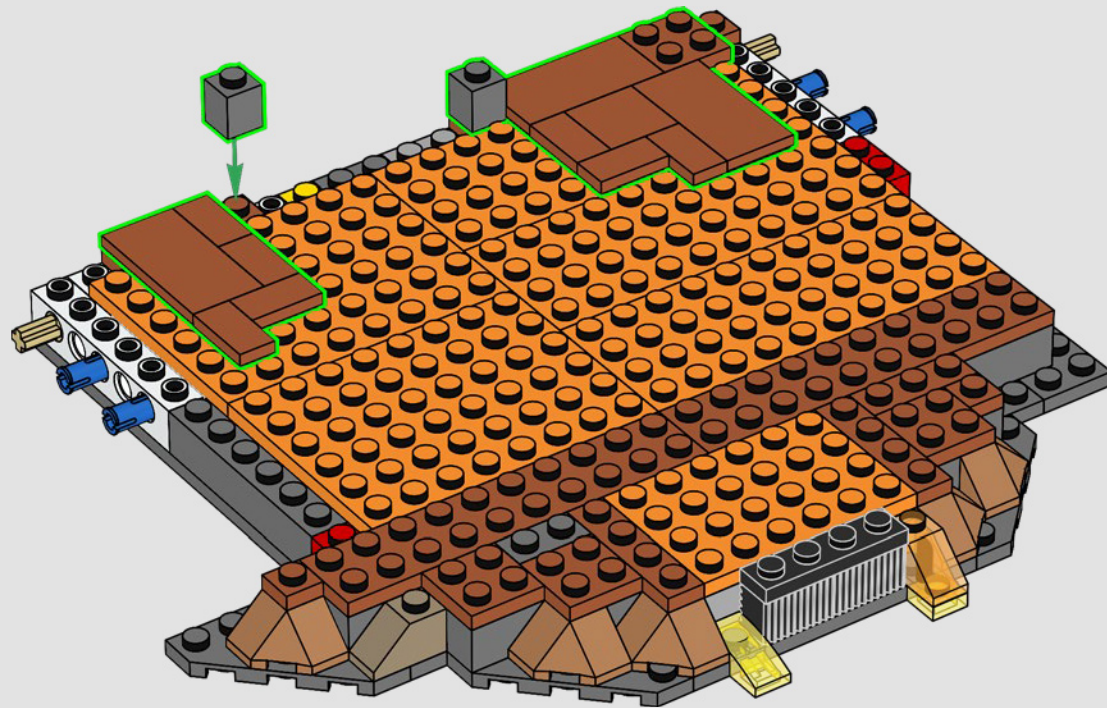

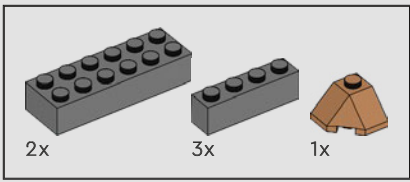

26

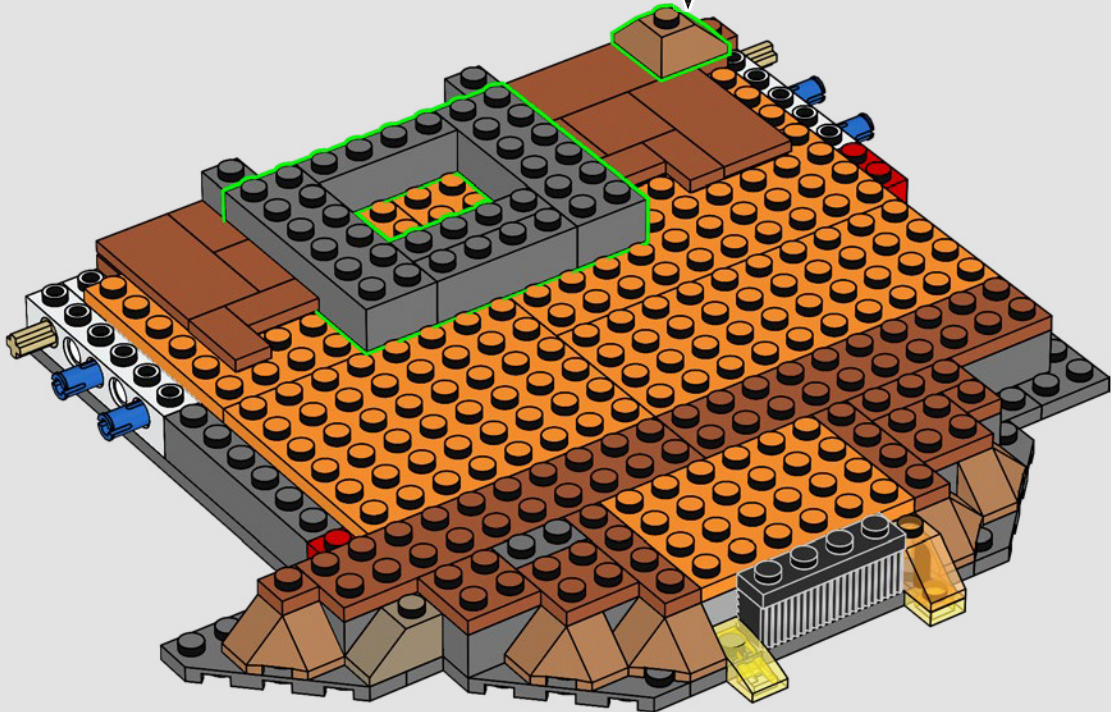

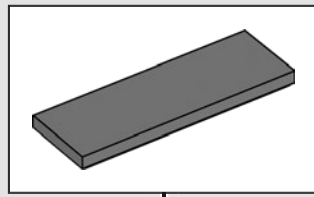
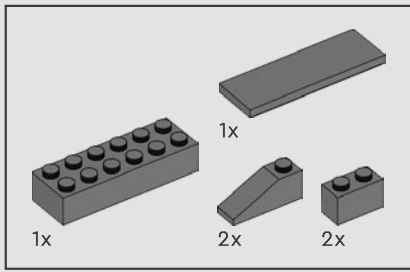

27

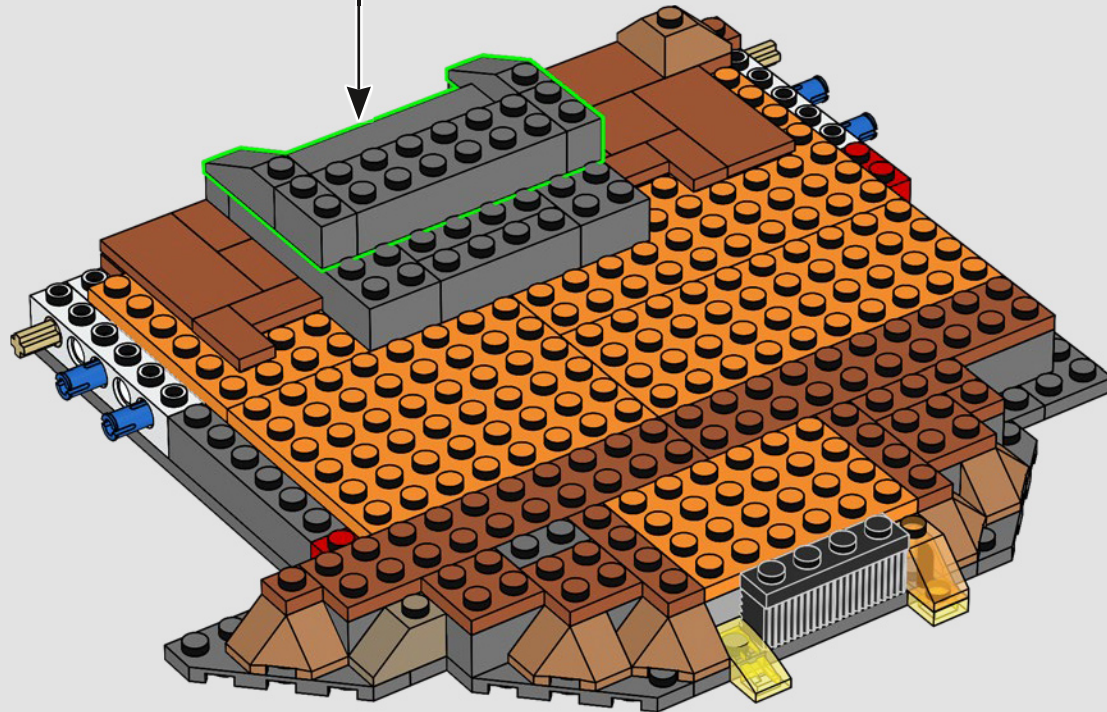

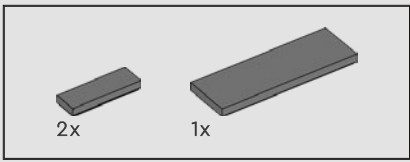

28

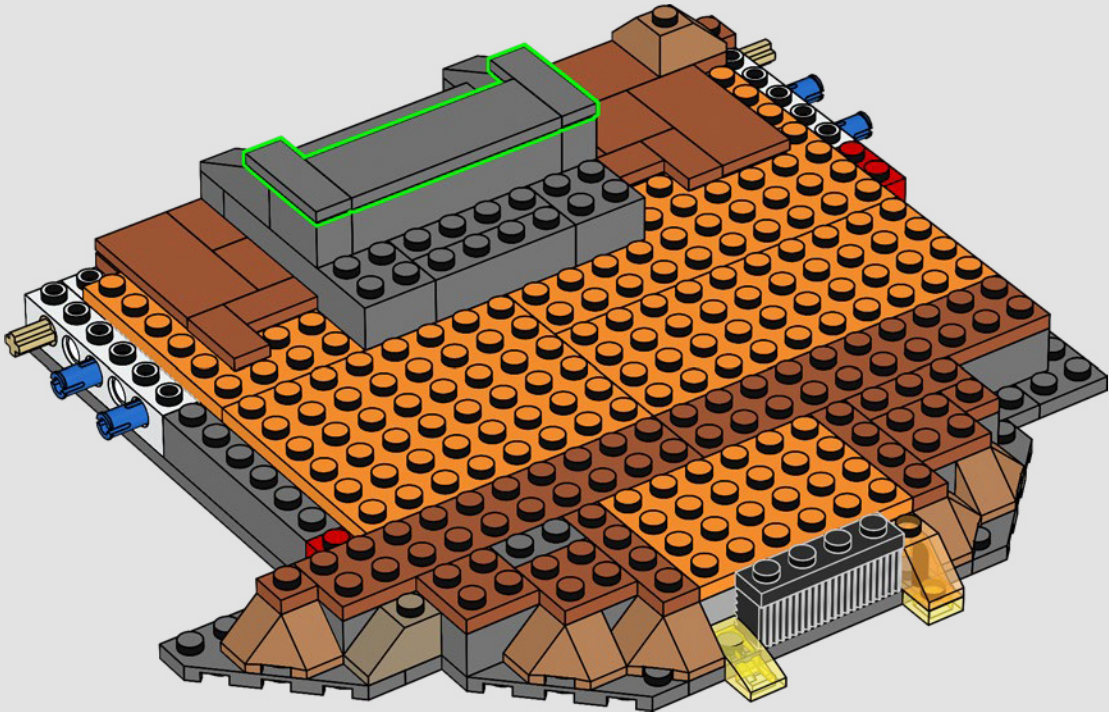

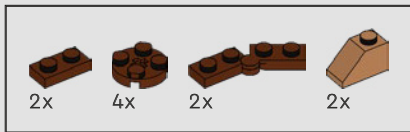

29

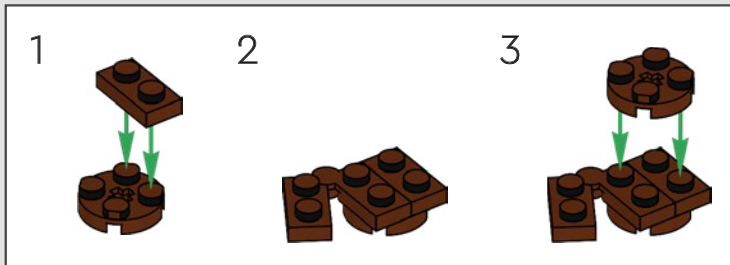
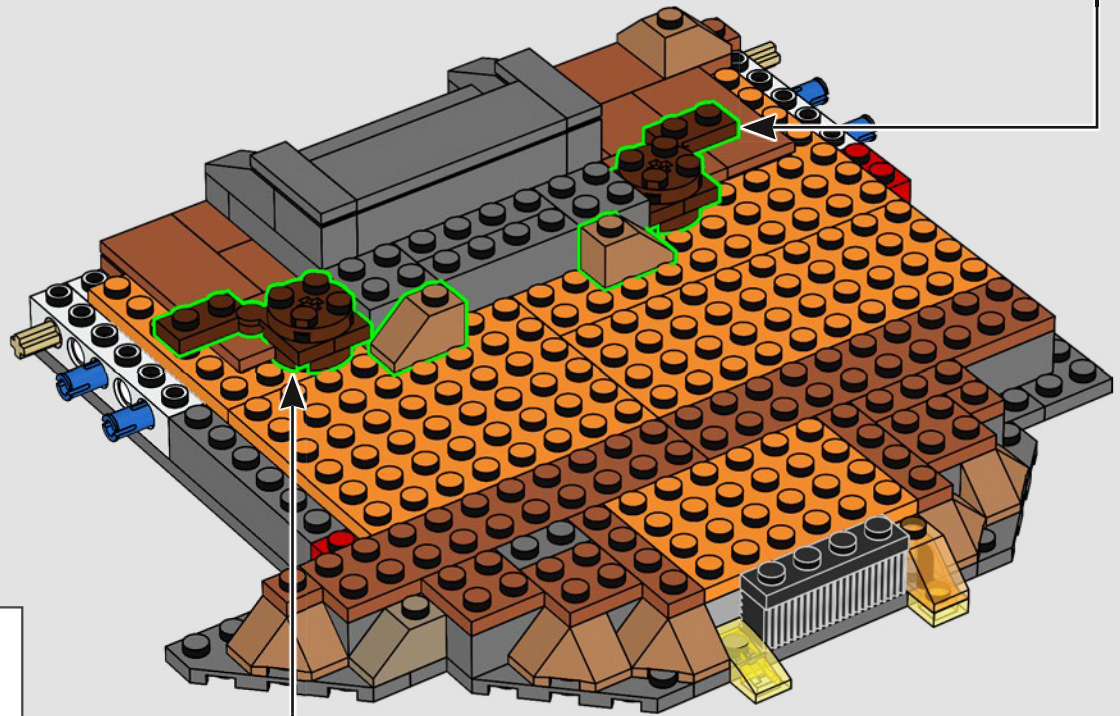
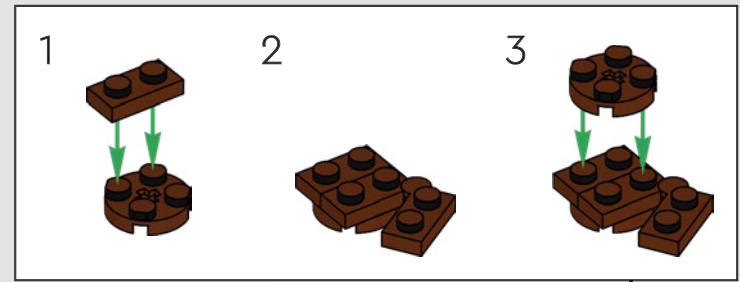

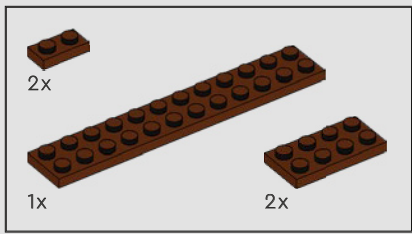

30

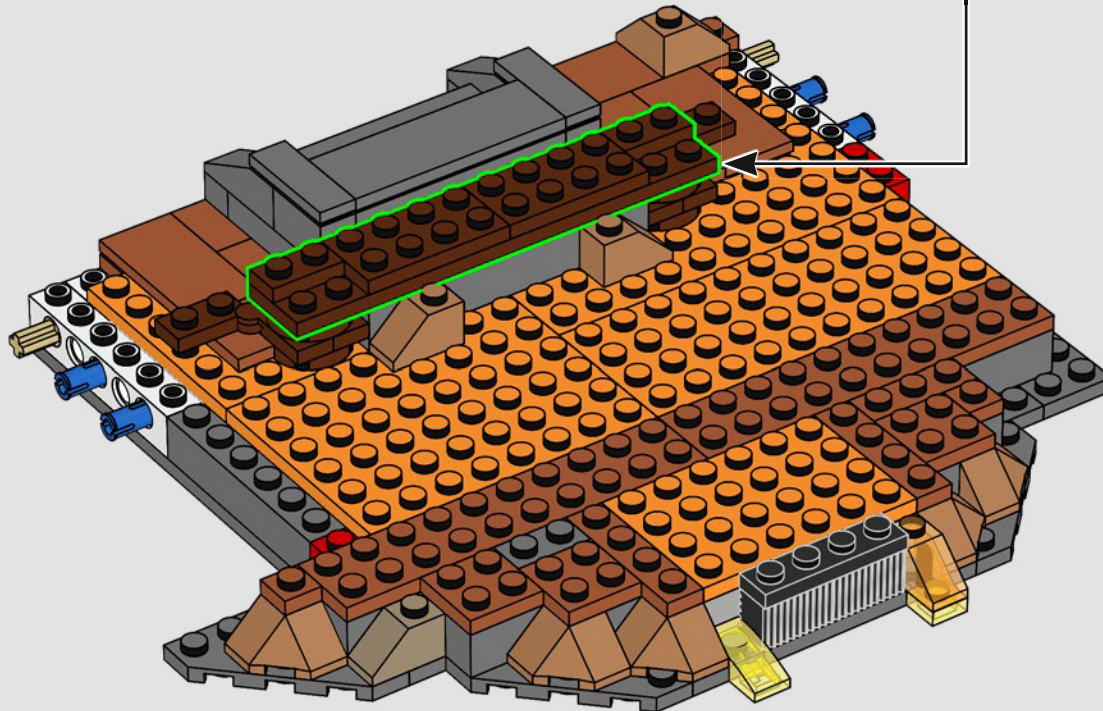
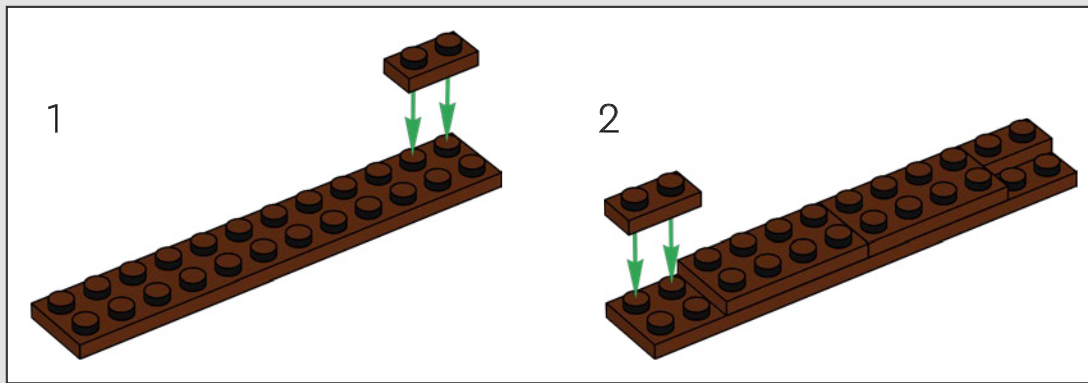

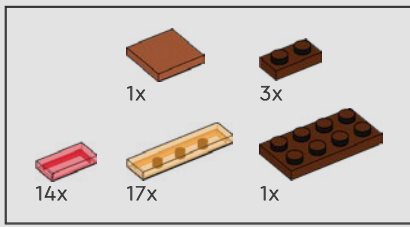

31

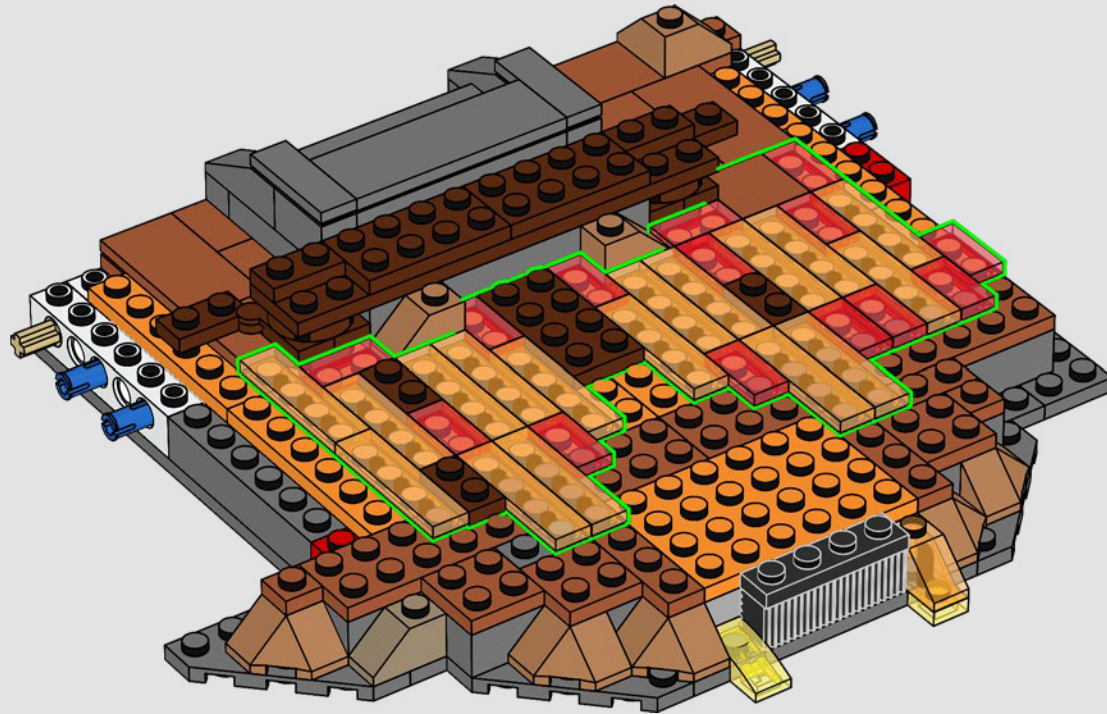

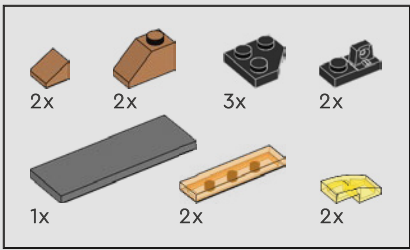

32

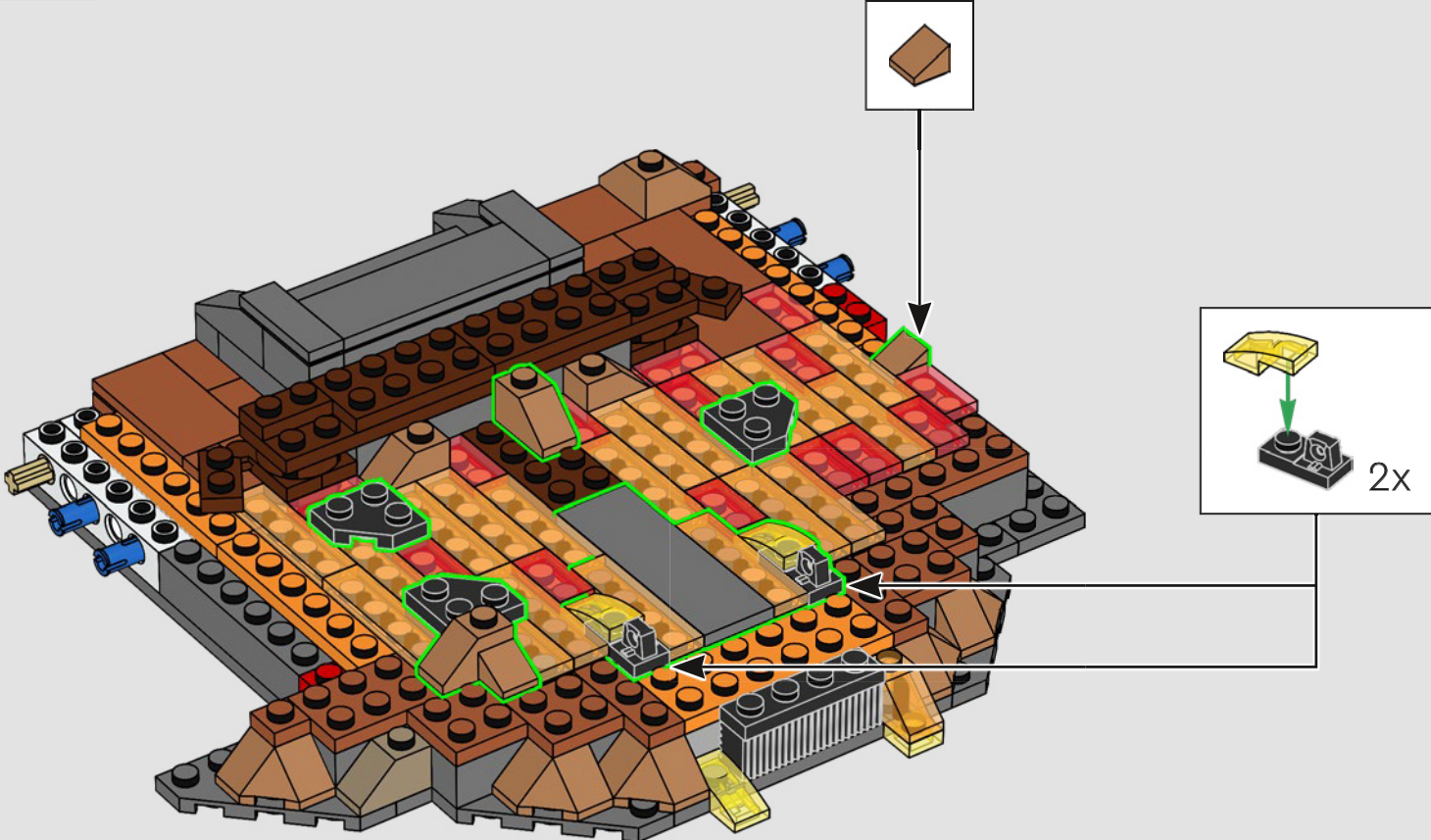

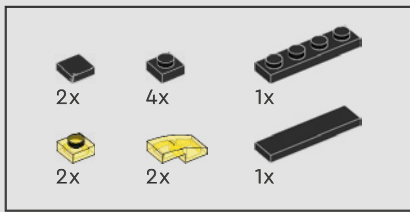

33

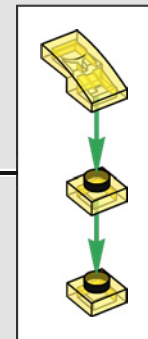
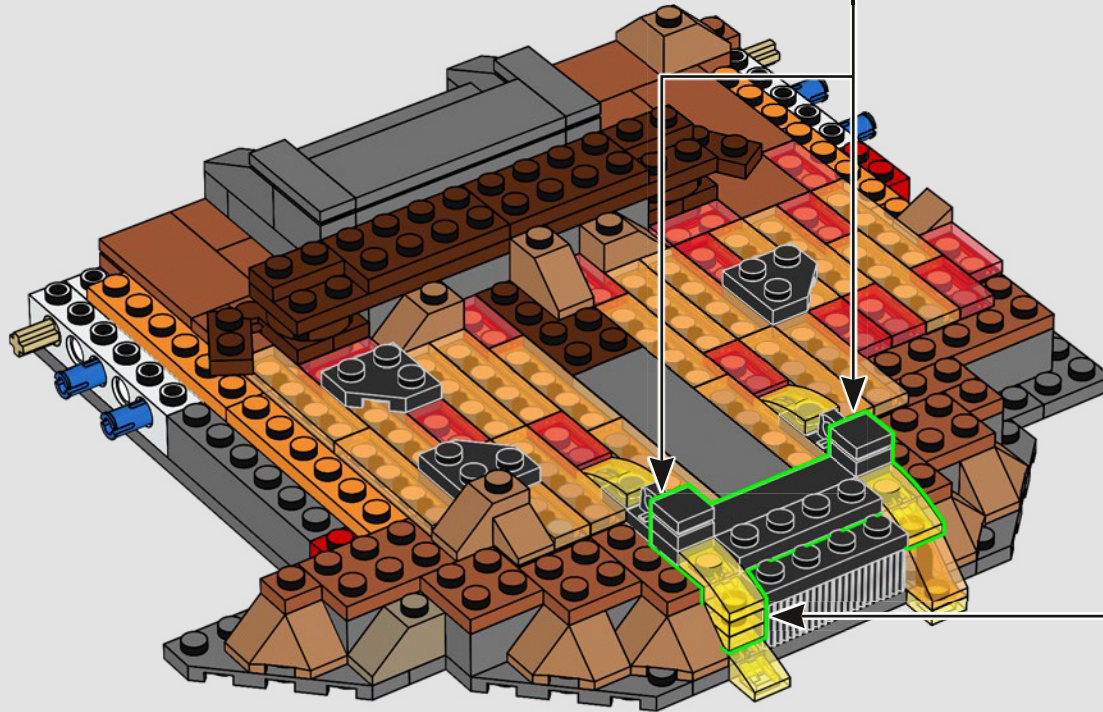
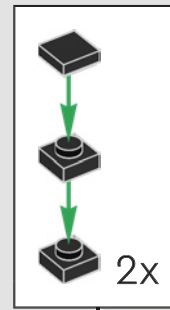



34

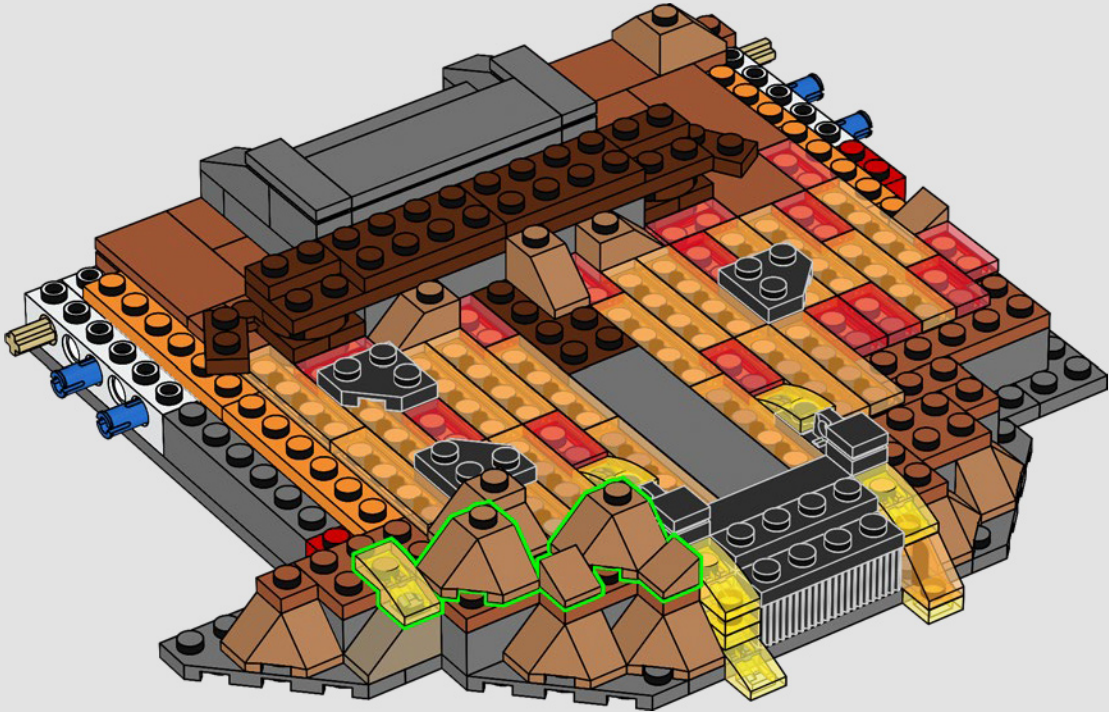

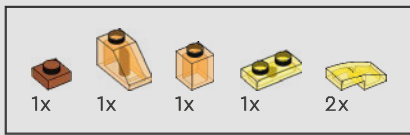

35

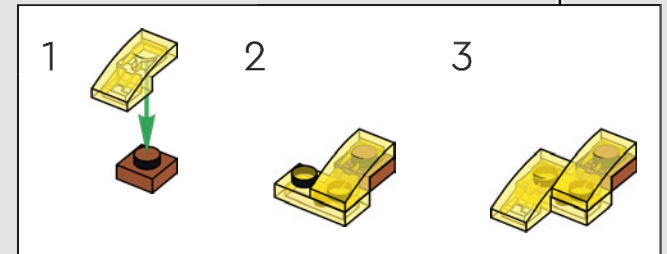
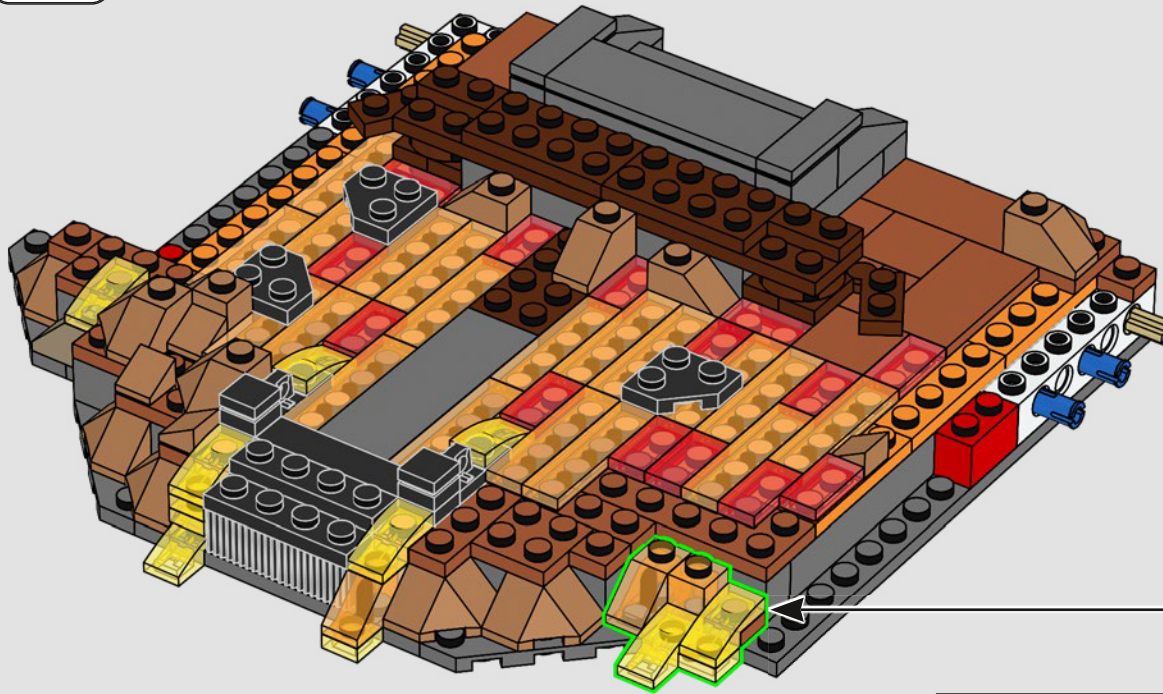



36



Das felsige Gelände, das den Dunklen Turm umgibt, ist in diversen Farbtönen nachgebildet. Die Felsen, die der Lava am nächsten sind, sind in den wärmsten Farben dargestellt. Das weiter entfernte Gestein ist dagegen in dunkleren und kälteren Farben nachgebildet.

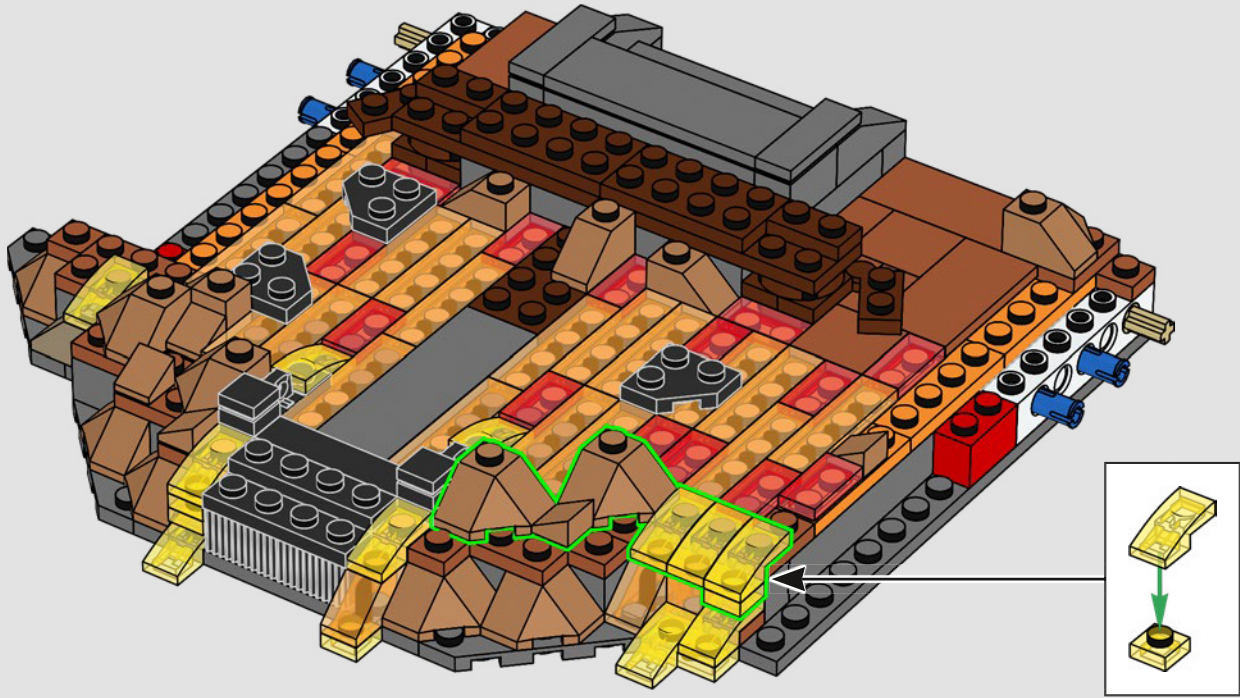

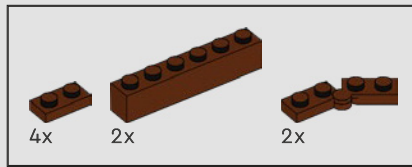

37

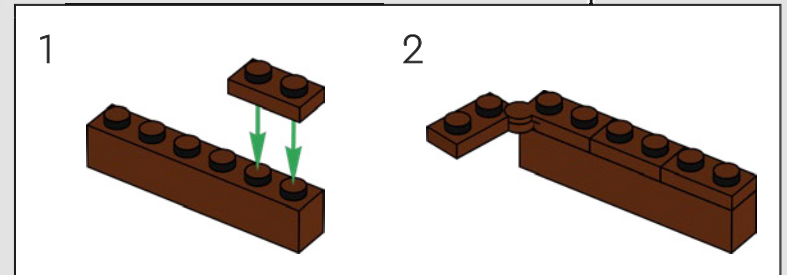
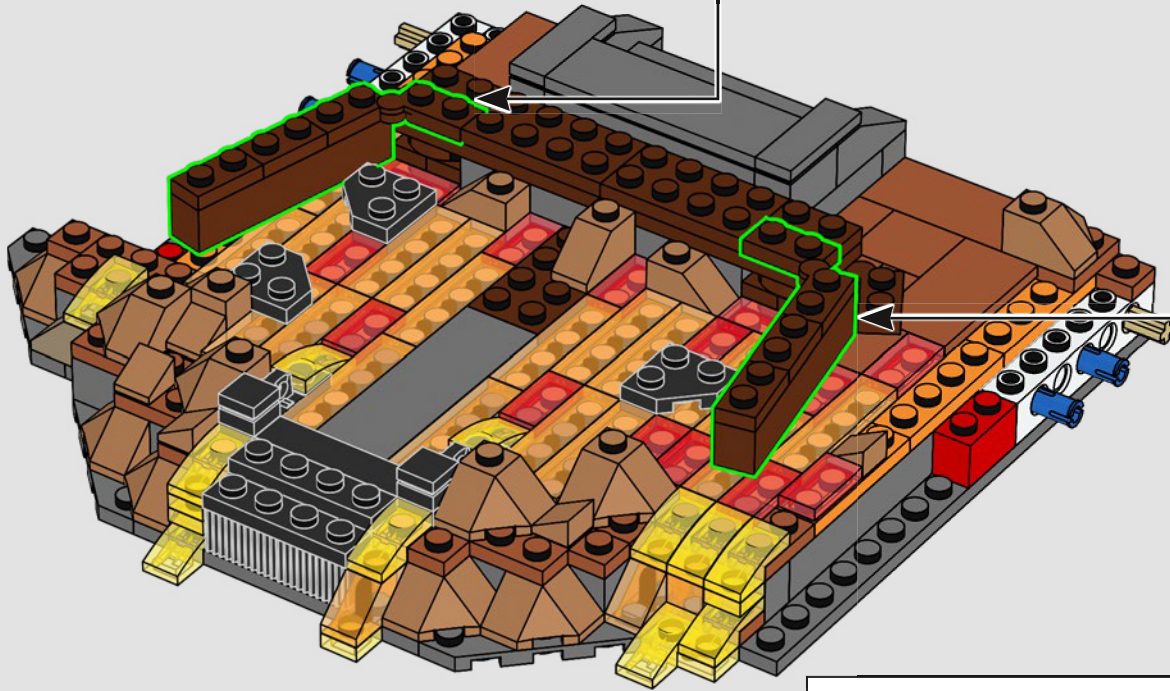
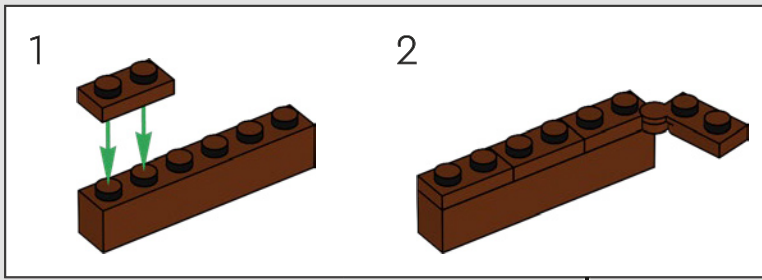

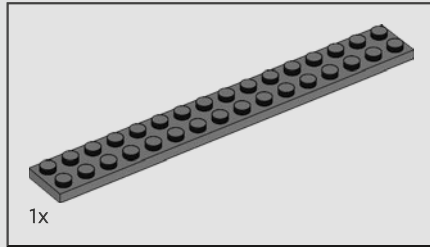
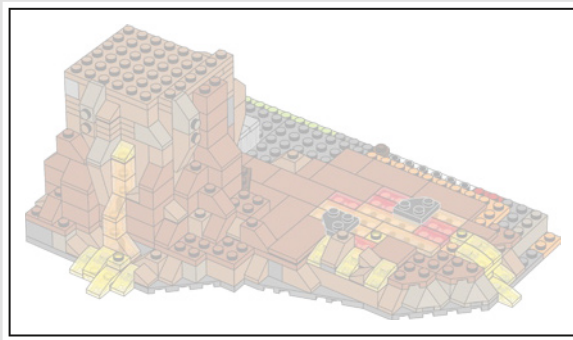

38

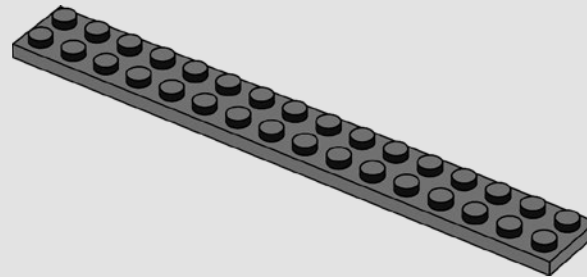

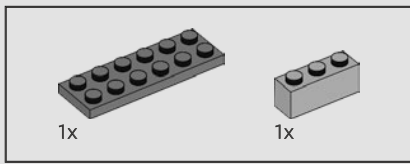

39

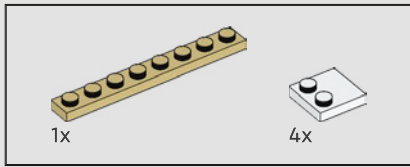
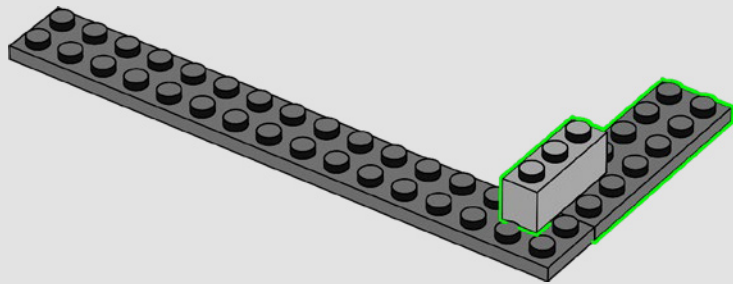

40

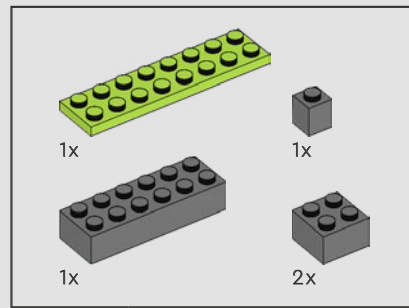
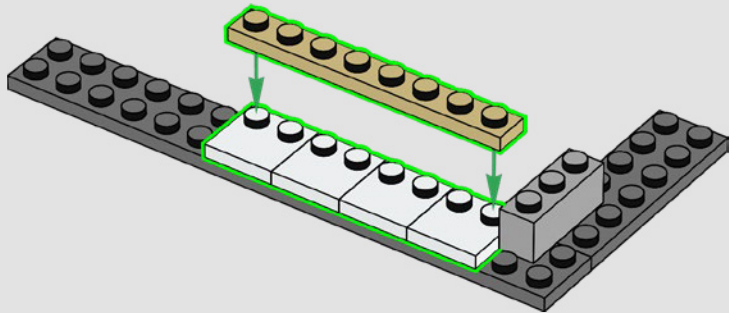

41

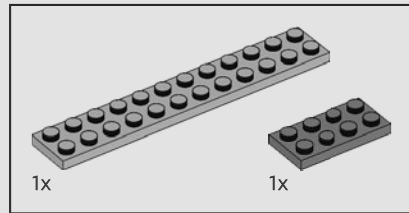
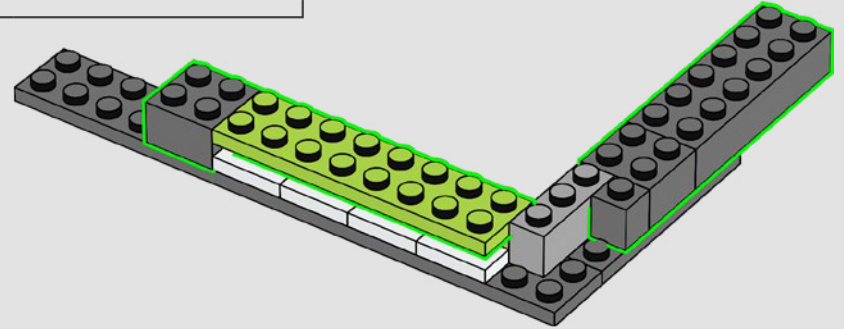

42

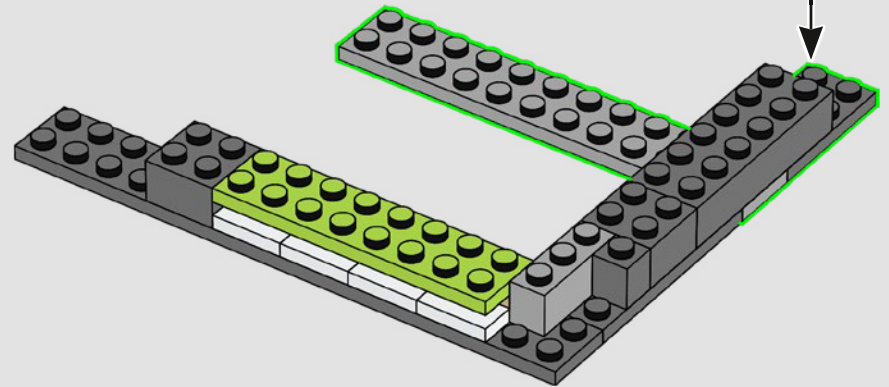

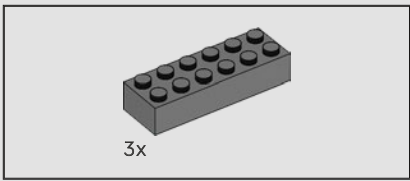

43

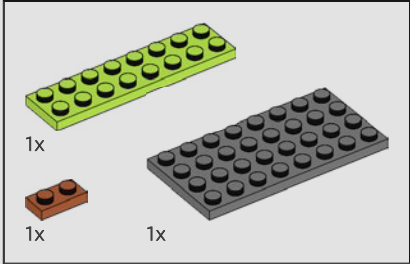
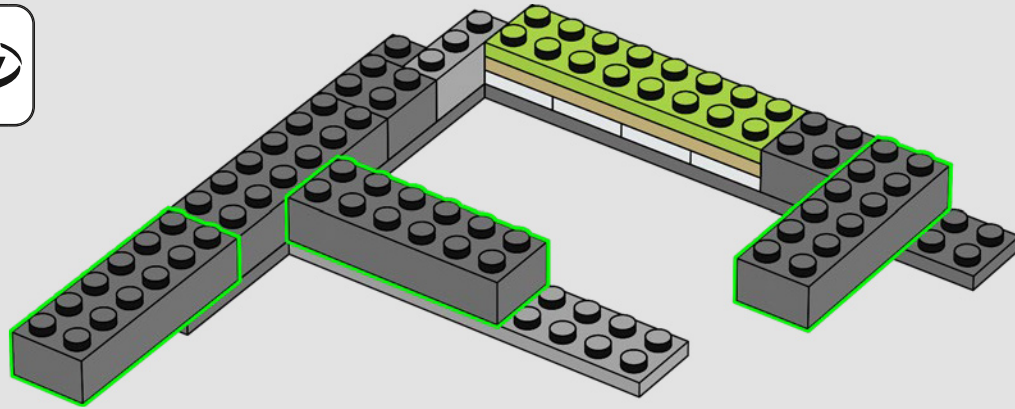

44

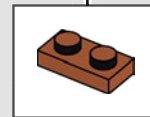
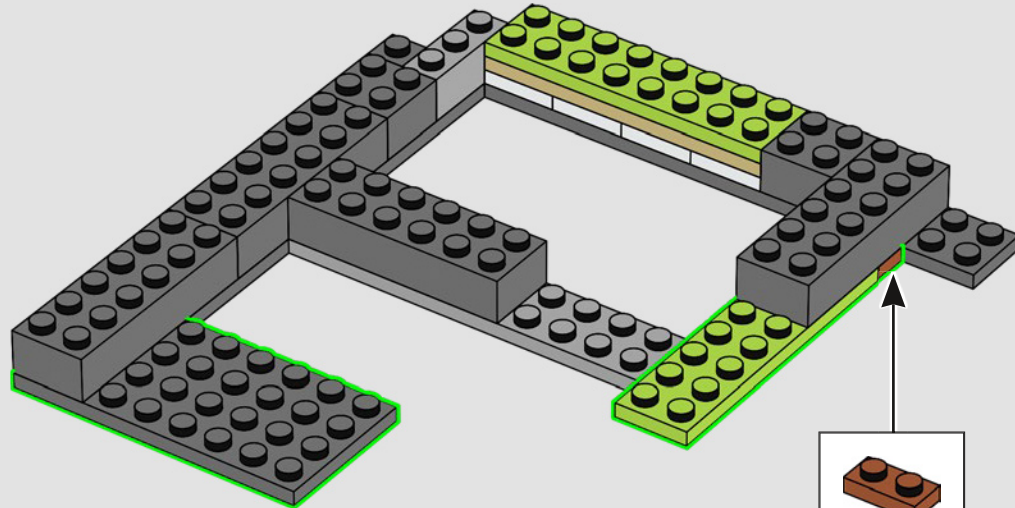

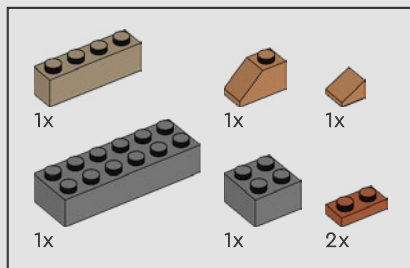

45

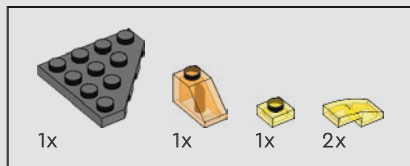
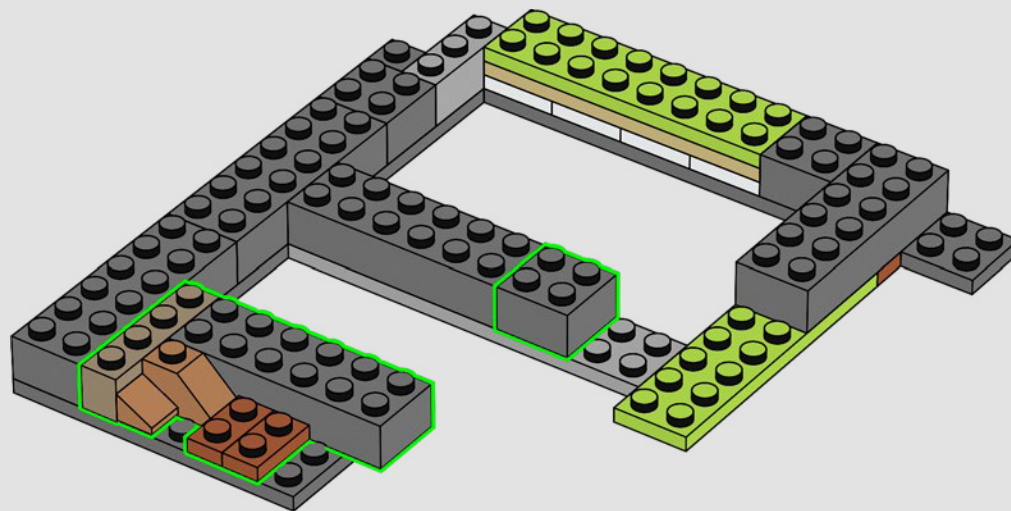

46

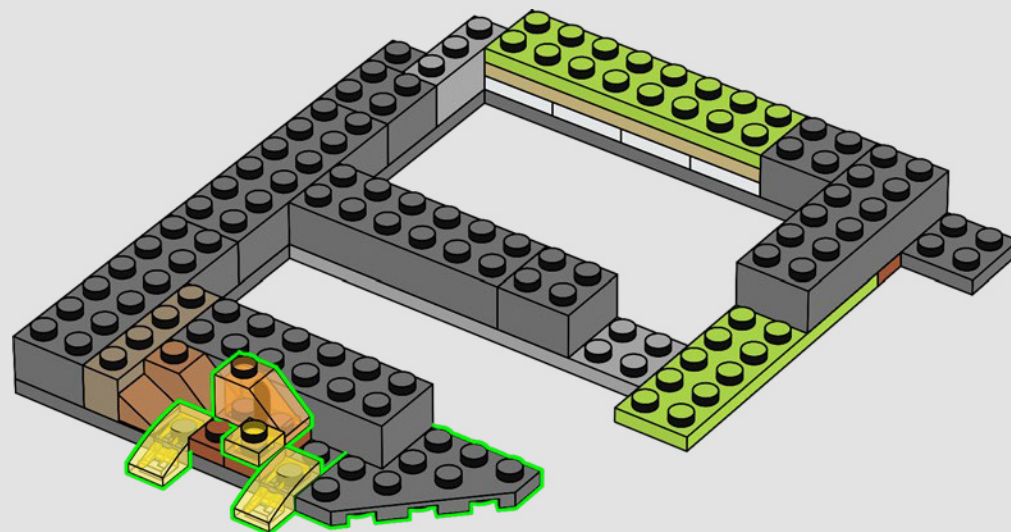

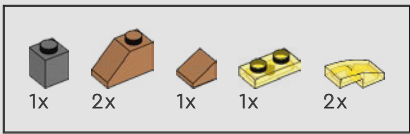

47

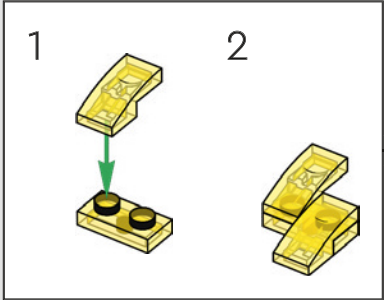
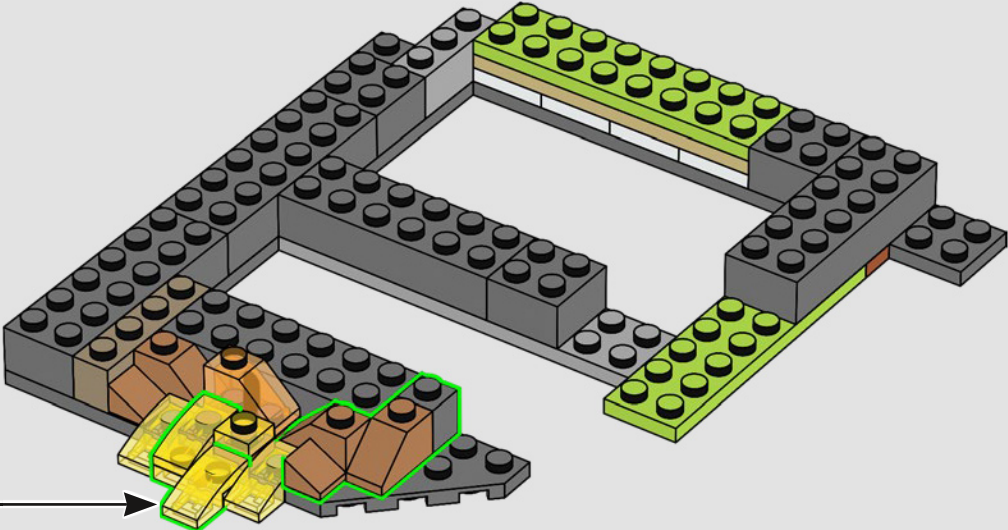

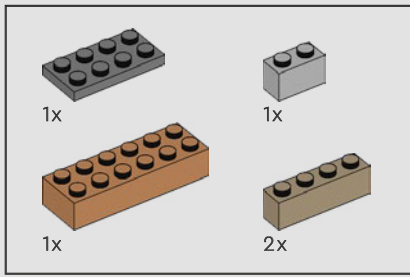

48

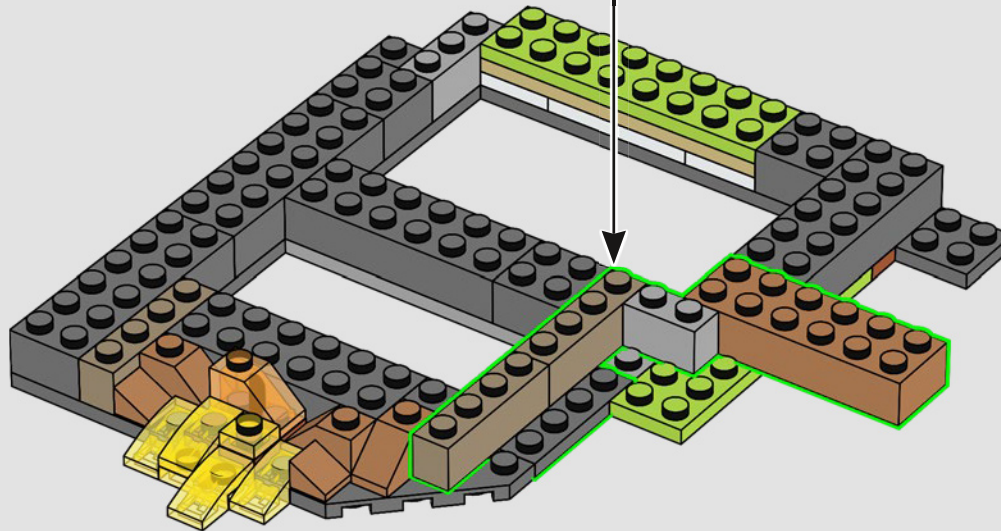
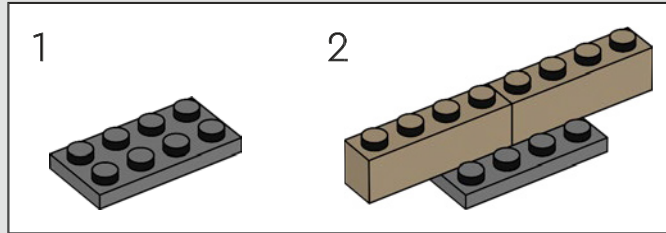

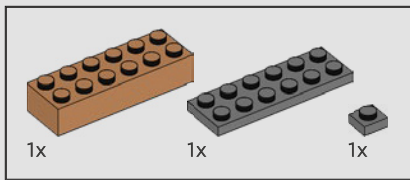

49

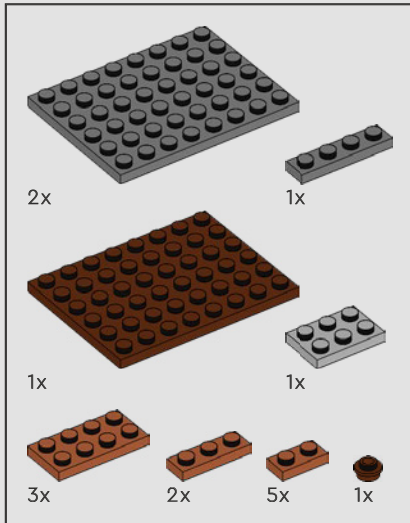
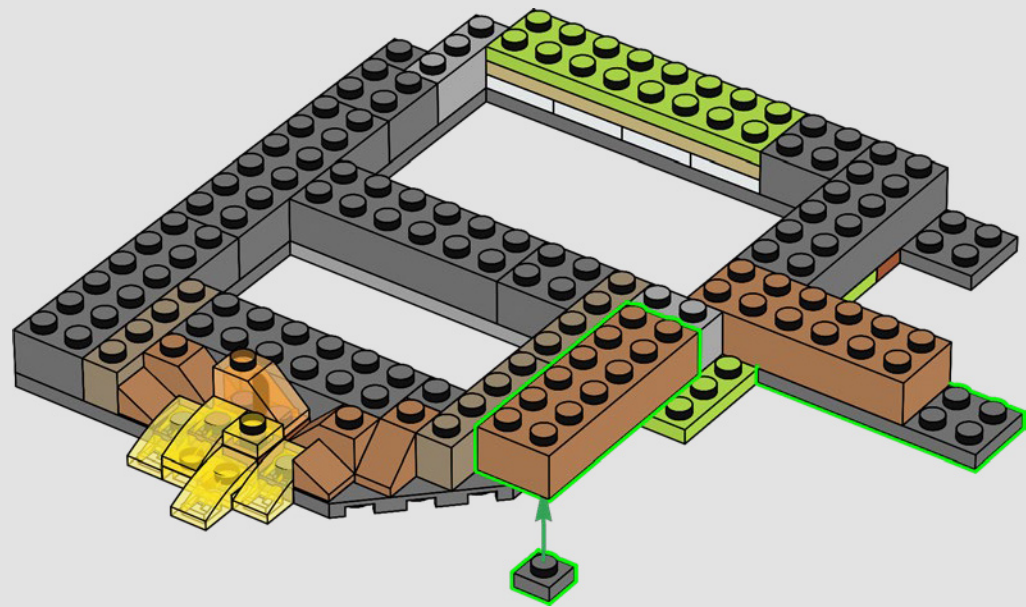

50



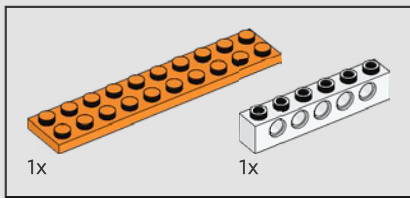

51

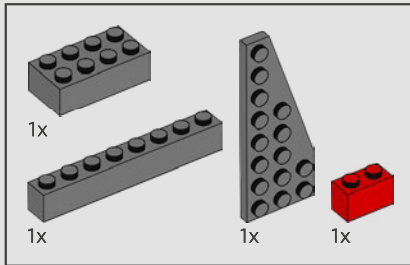
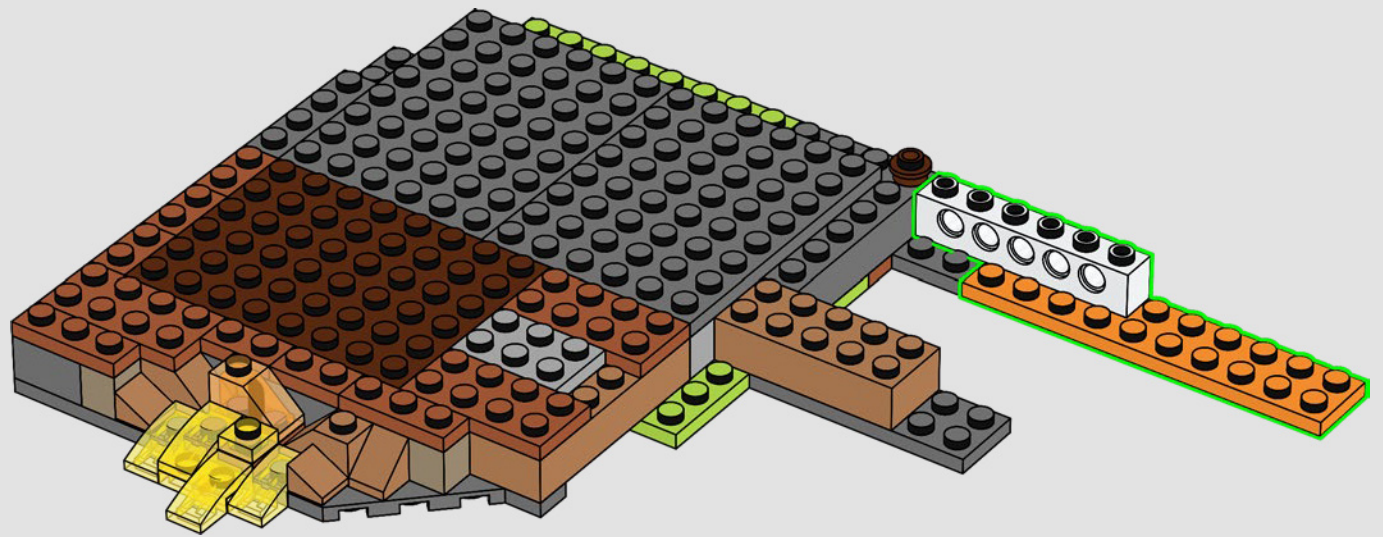

52

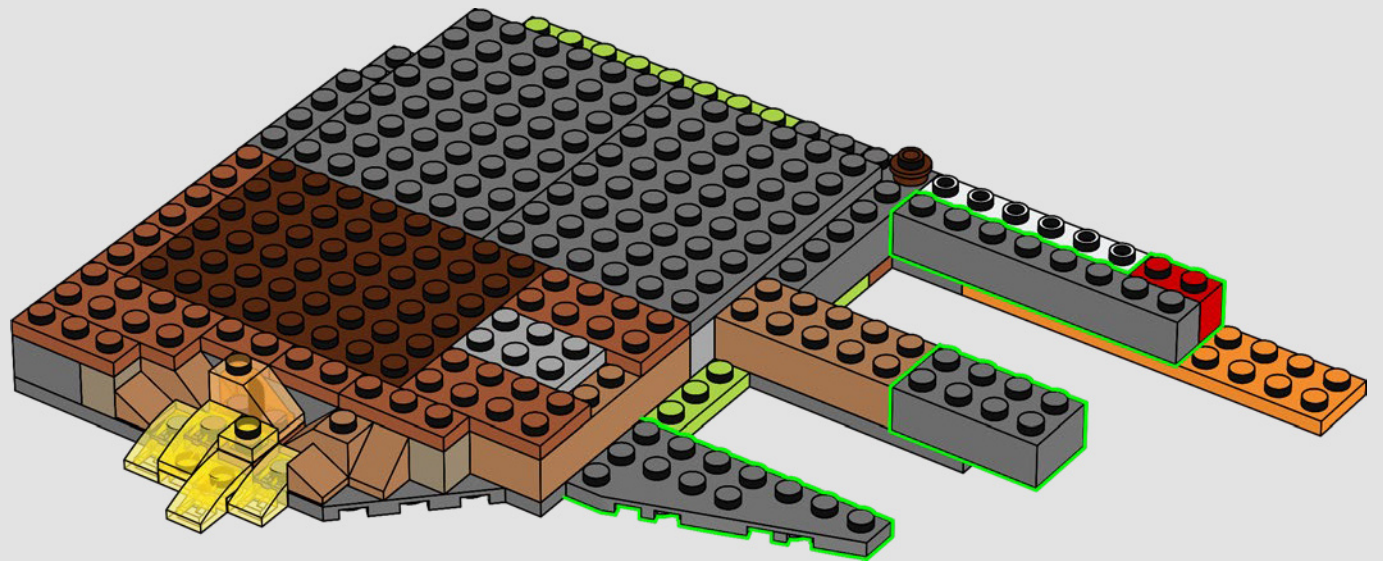



Als Orks verkleidet brauchten Frodo Beutlin und Samweis Gamdschie ungefähr zehn Tage, um durch das raue Gelände von Mordor™ bis zum Schicksalsberg zu gelangen.

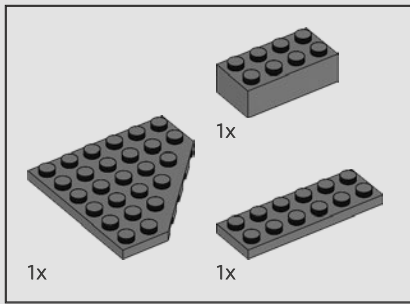

53

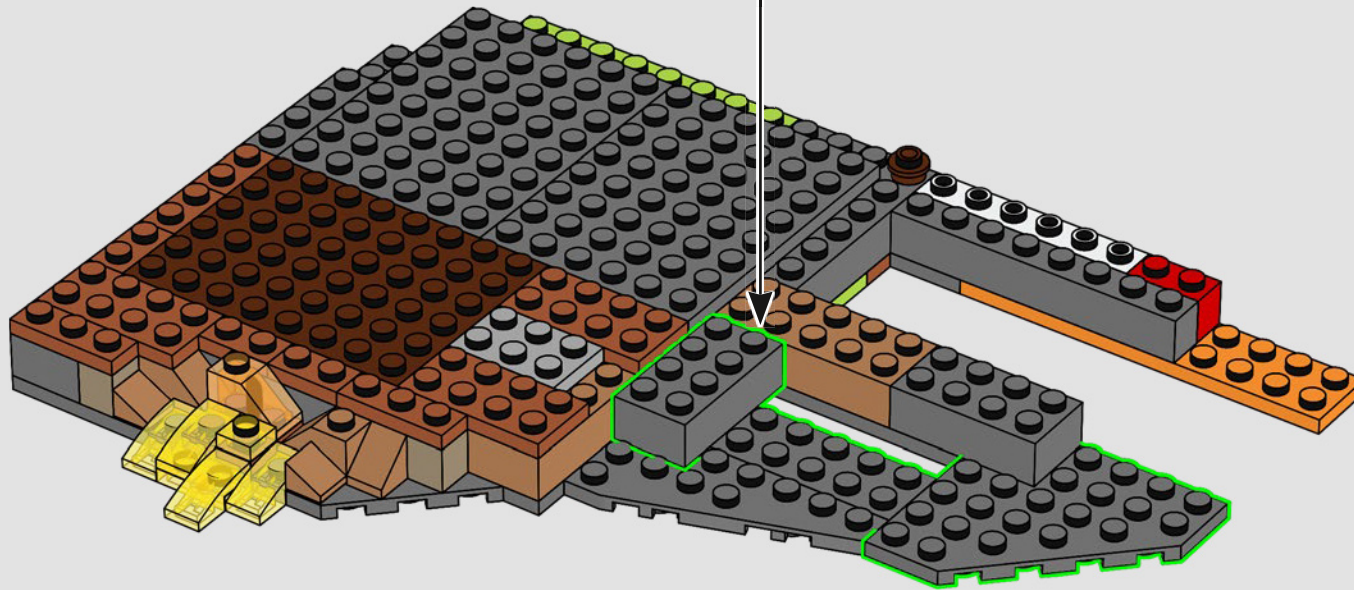
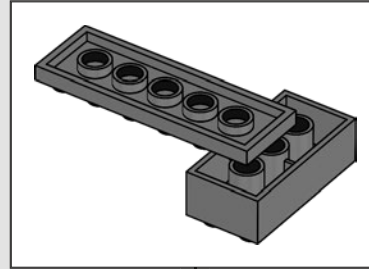

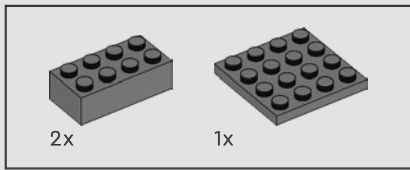

54

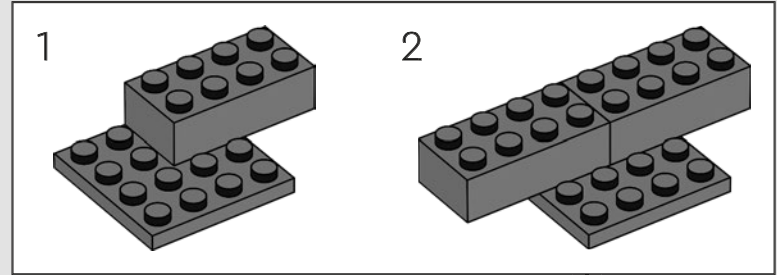

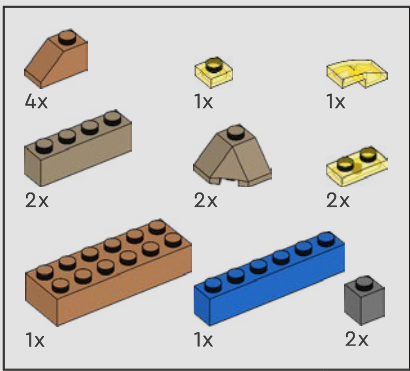

55

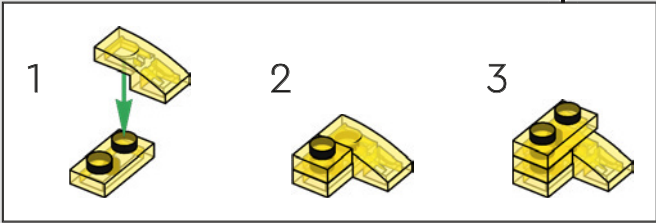

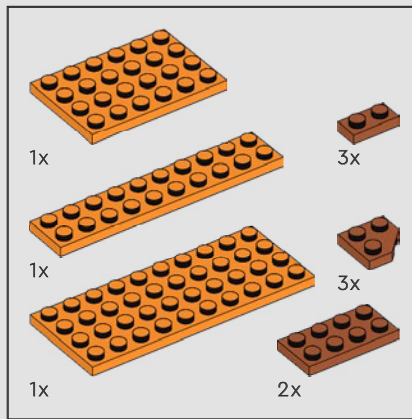

56

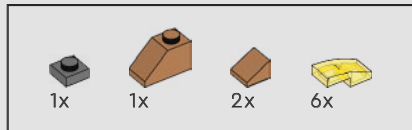

57

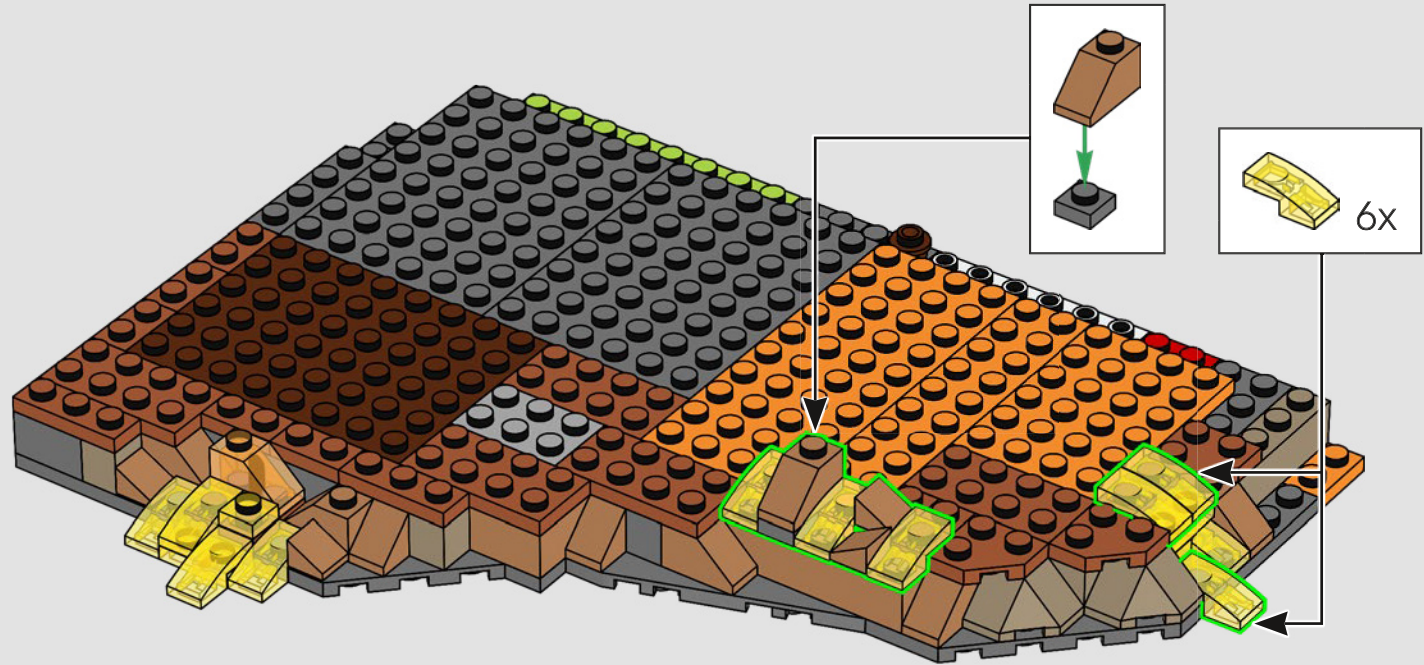



Die Minifigur Gollum™ wurde für dieses Set neu entworfen und ist mit einem neuen Gesicht bedruckt.

1



2

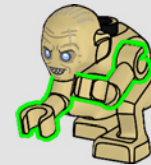

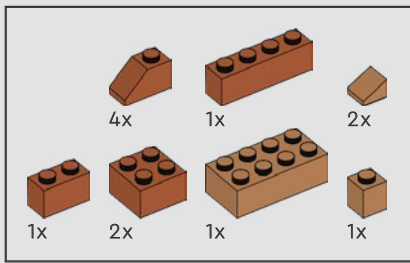

58

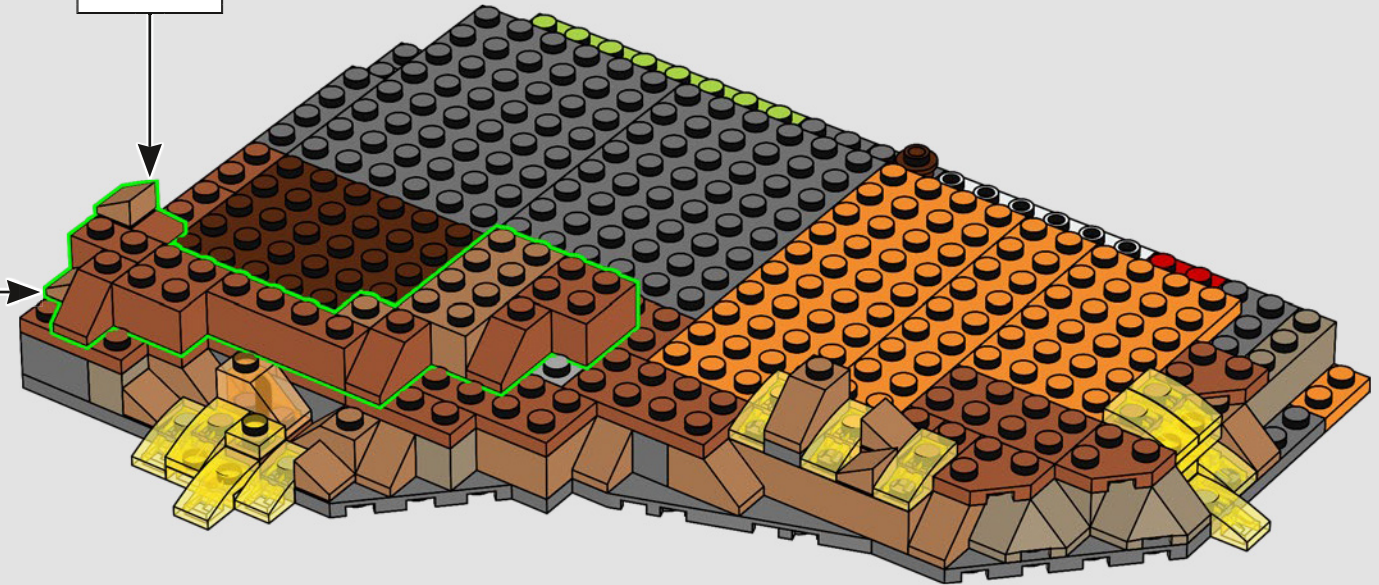
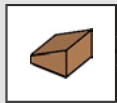
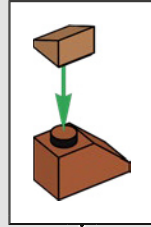

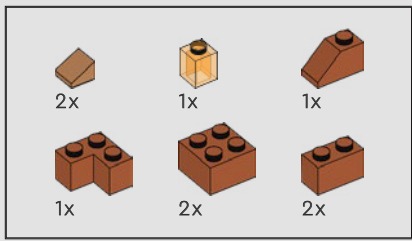

59

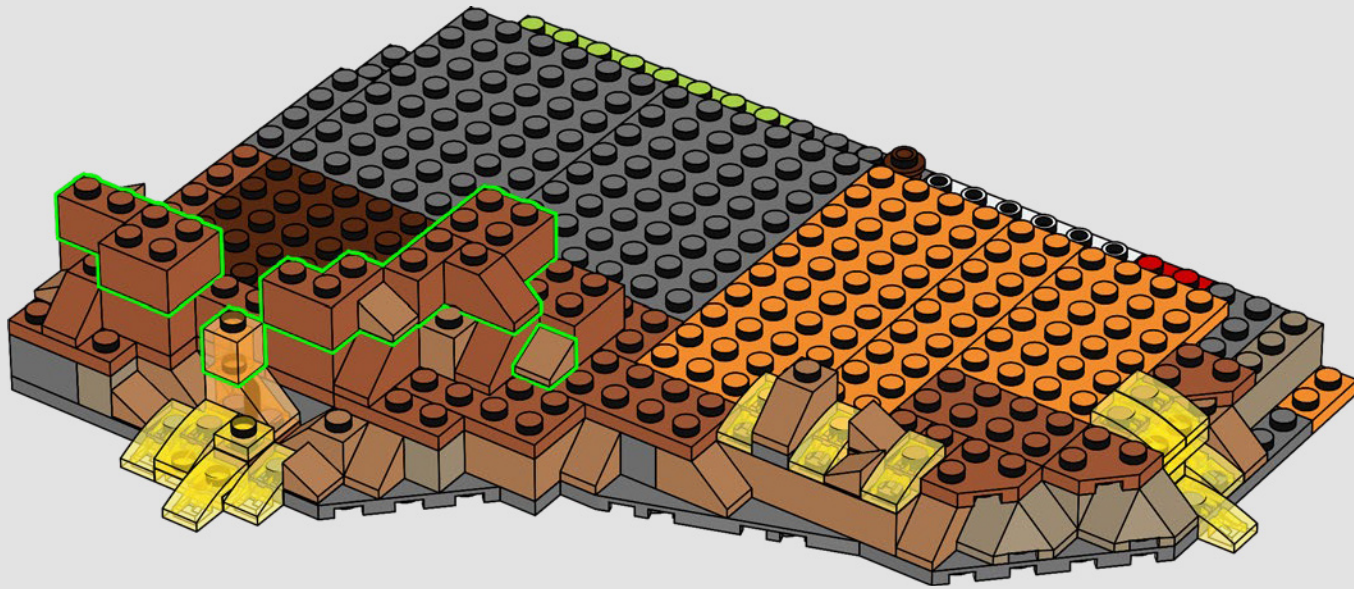

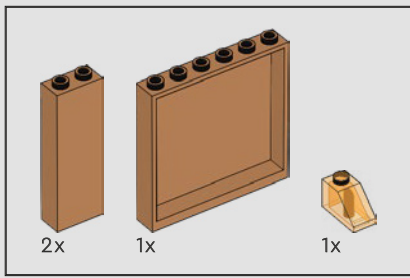

60

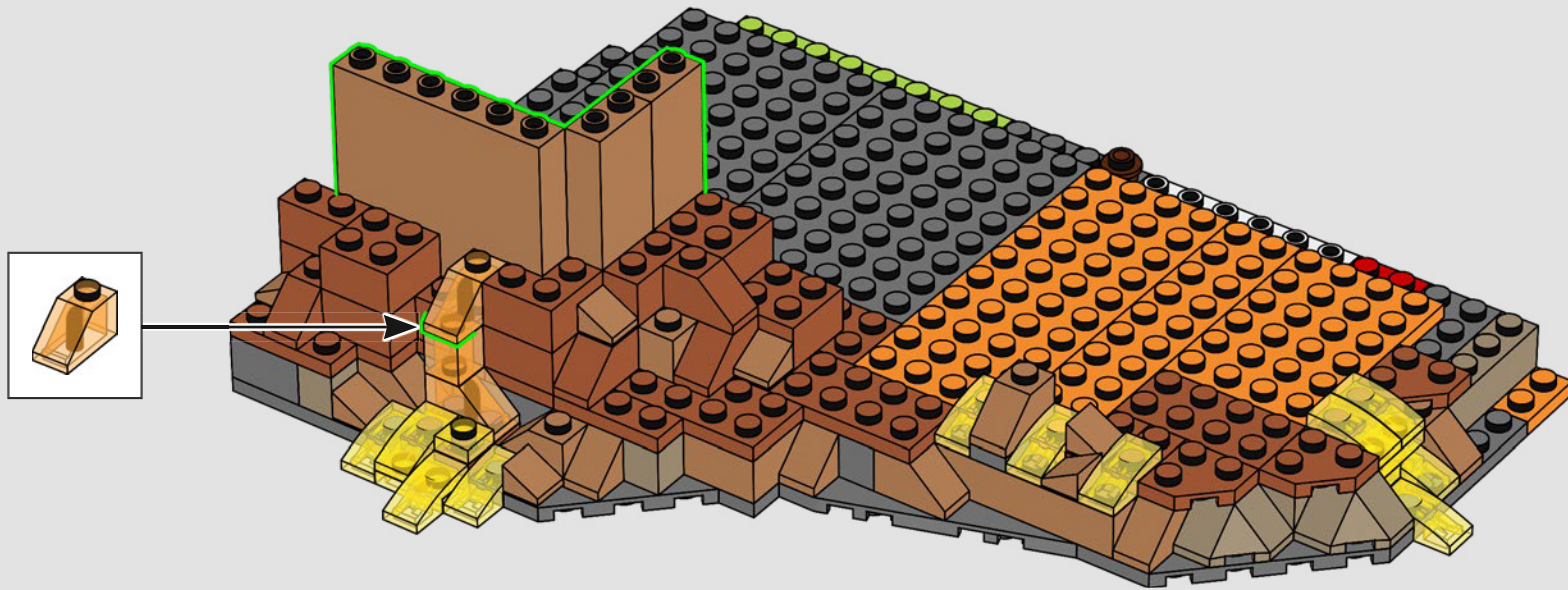

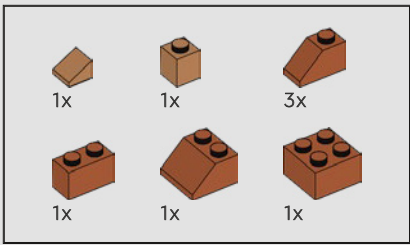

61

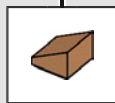
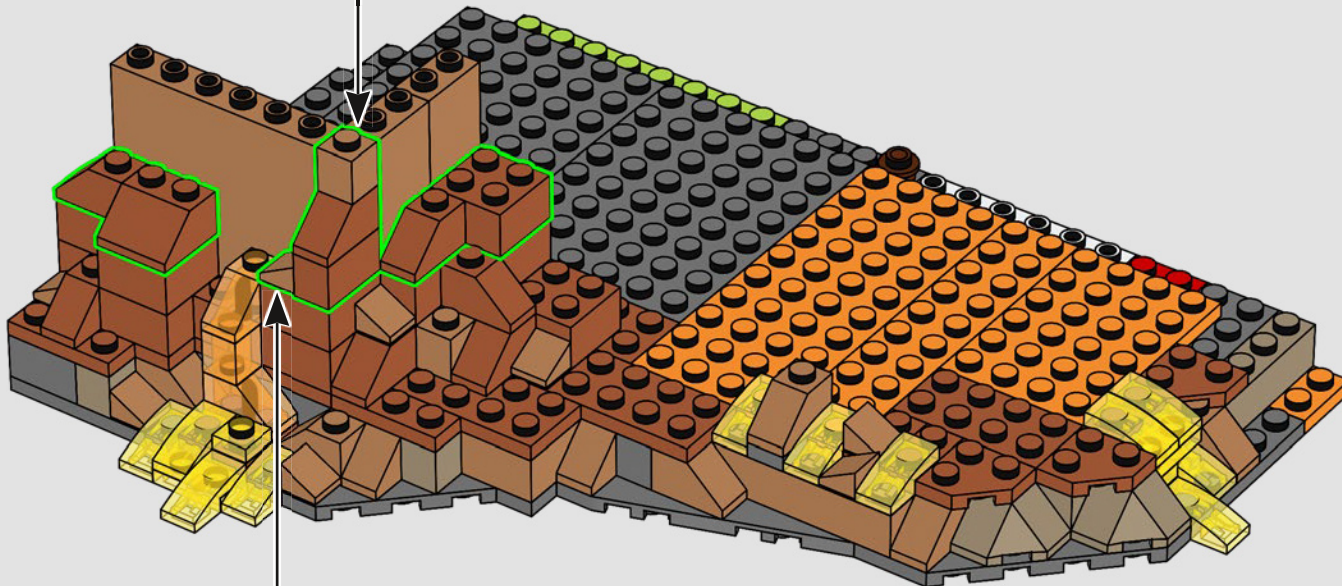
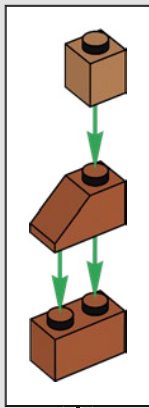

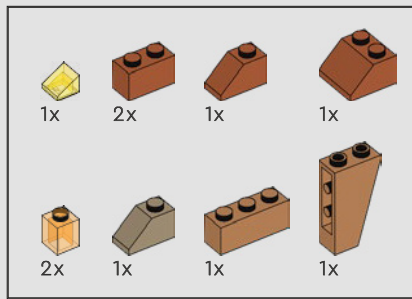

62

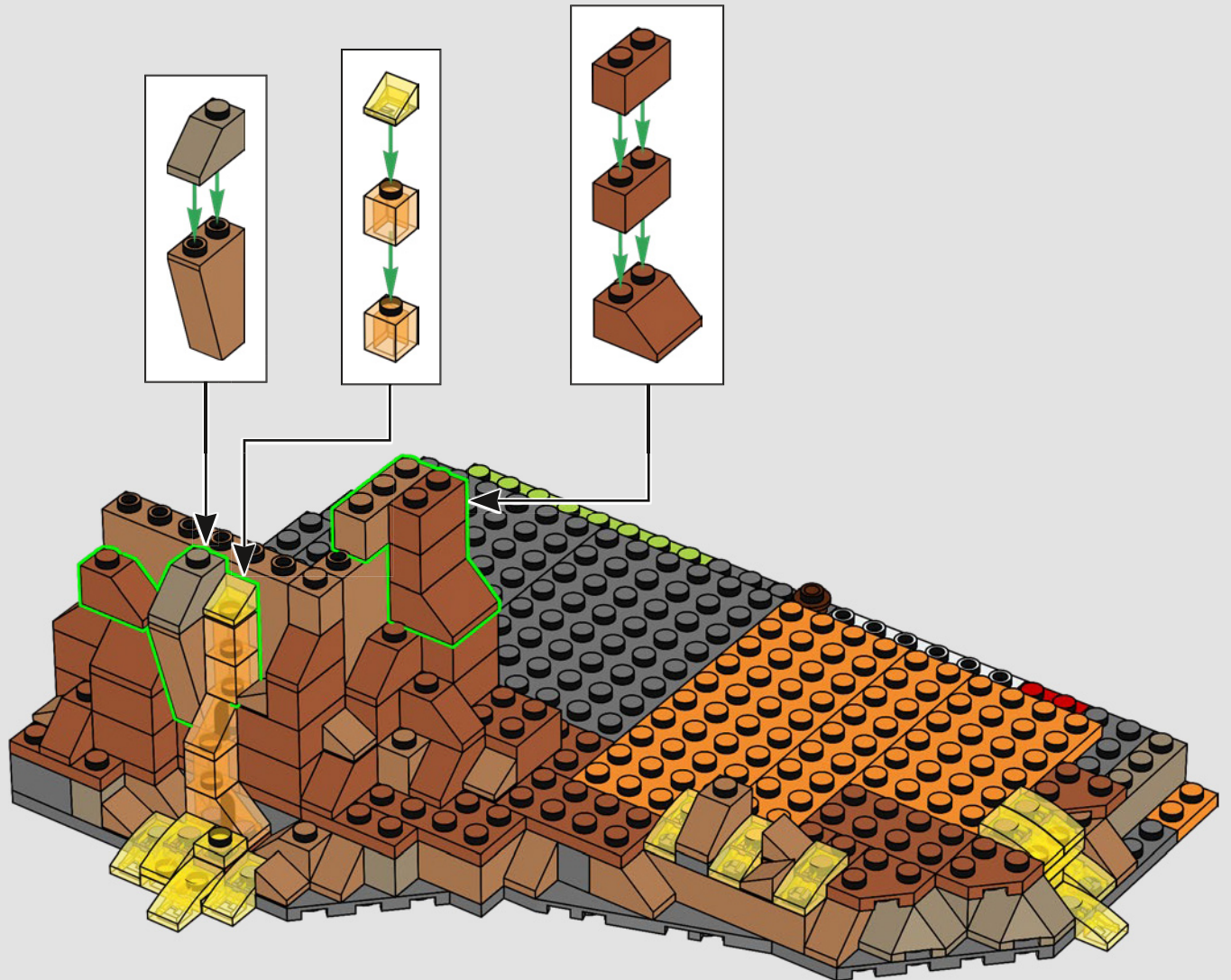

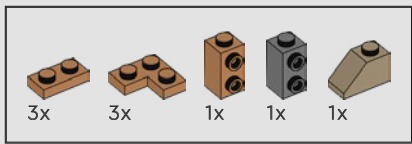

63

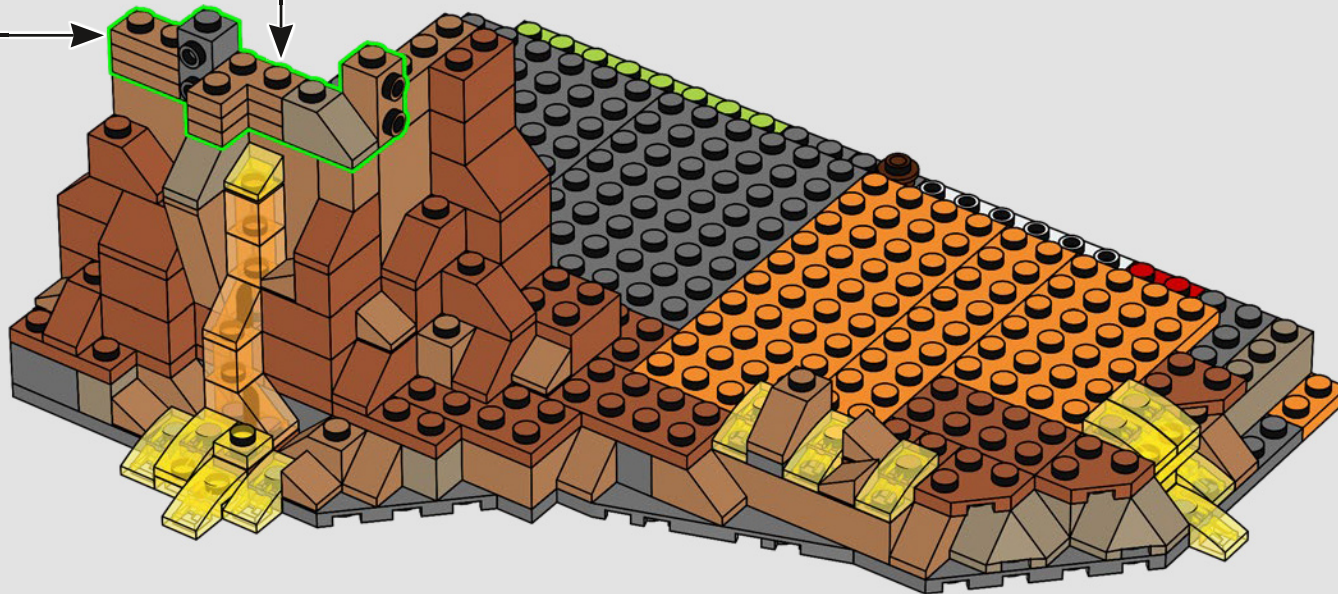
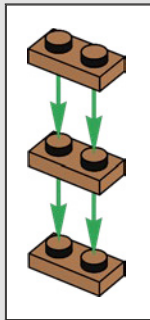
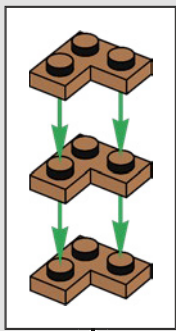

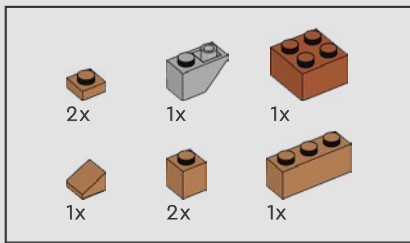

64

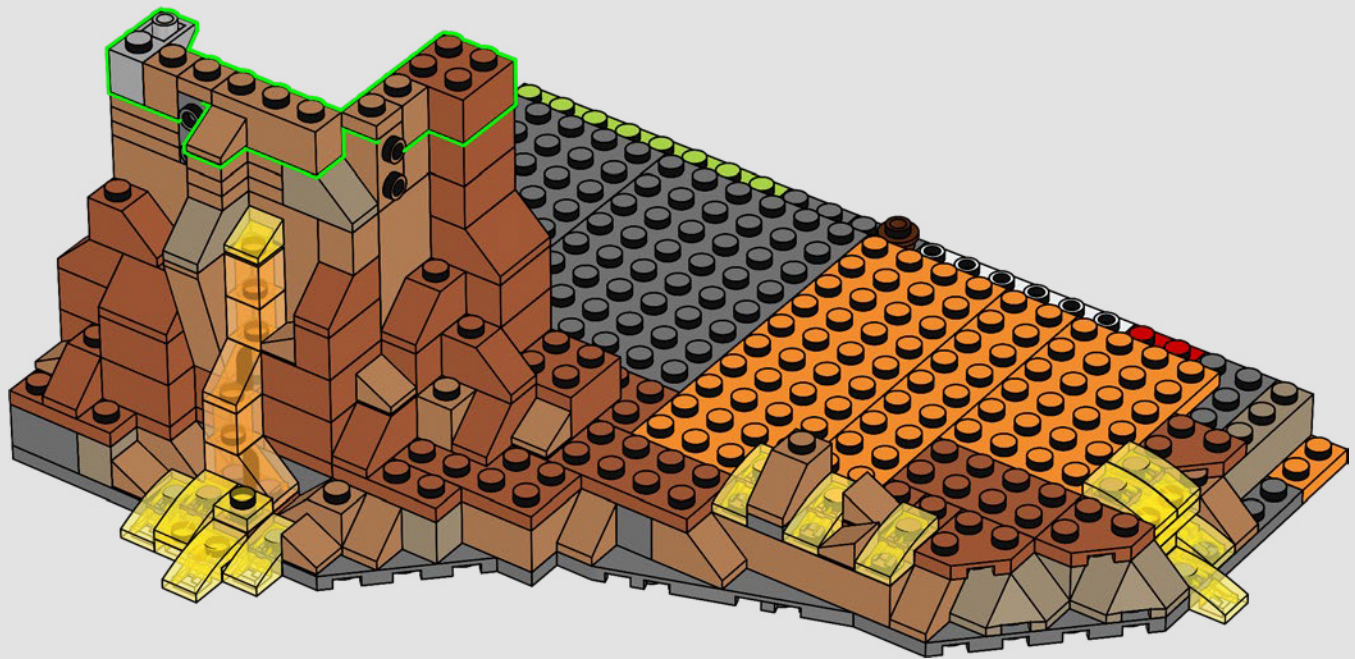

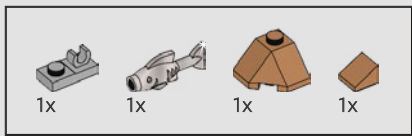

65

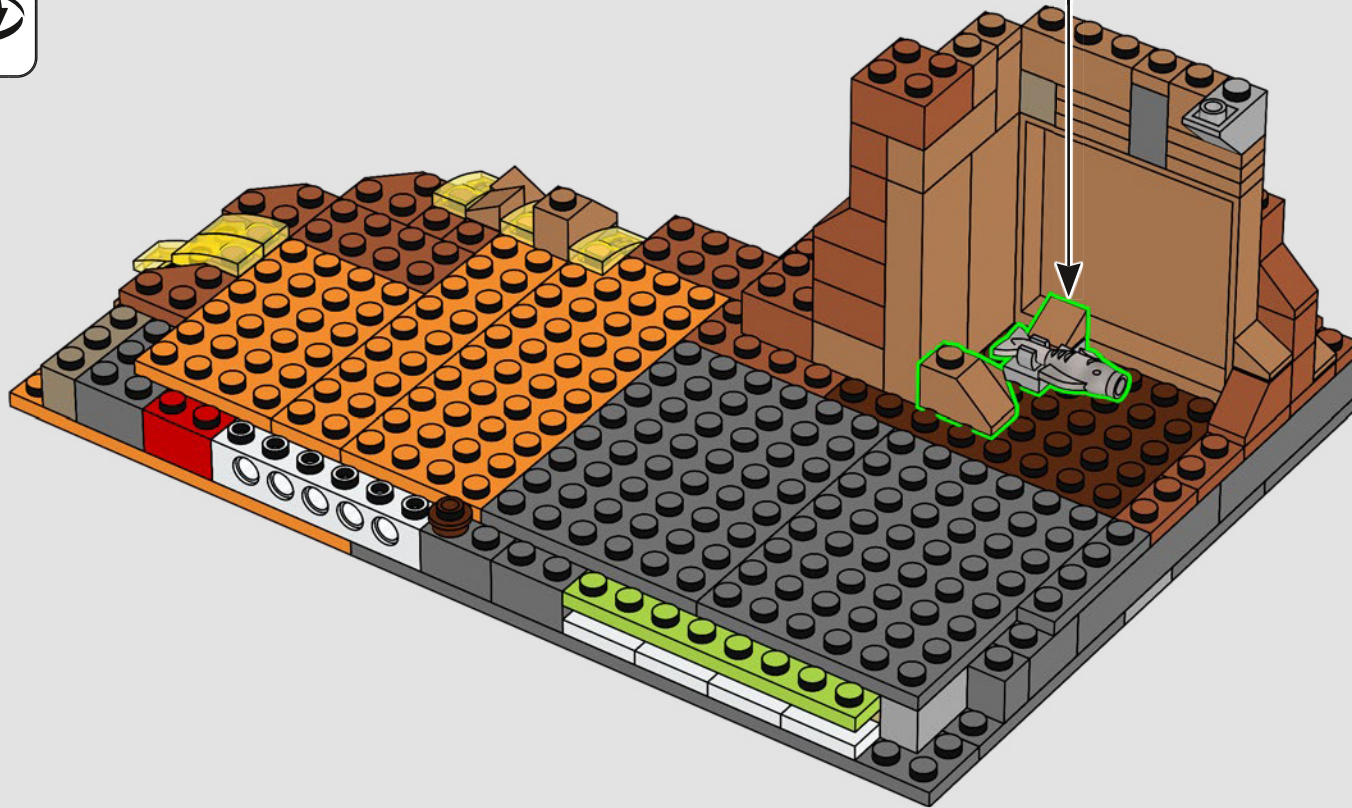
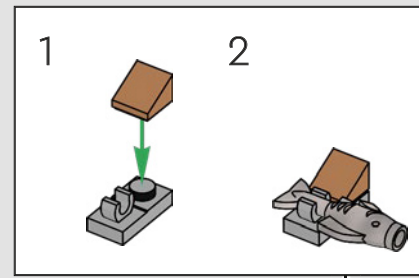

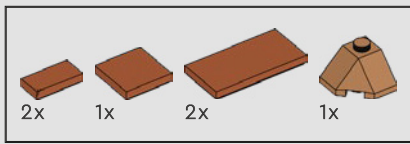

66

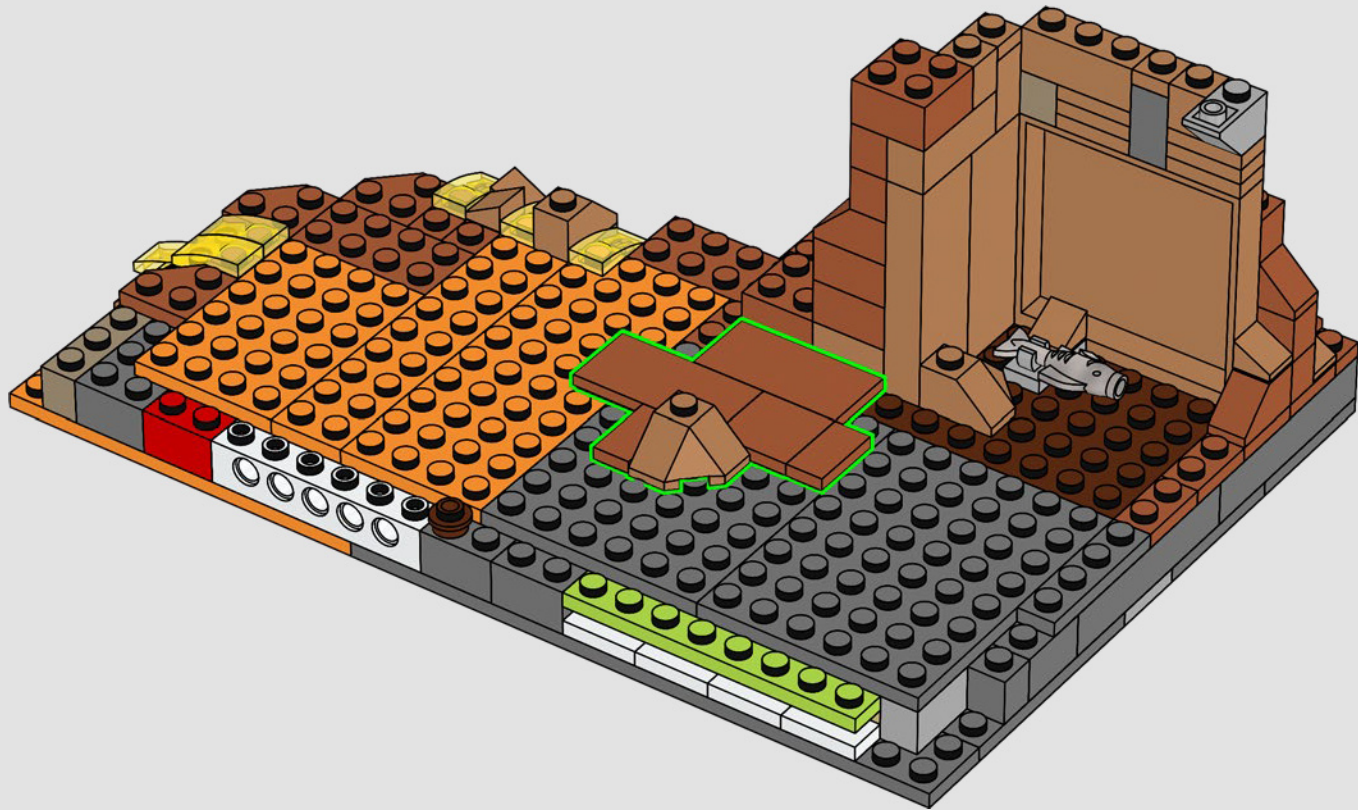

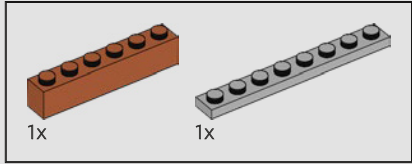
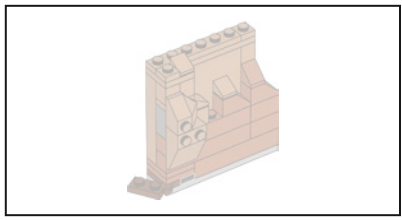

67

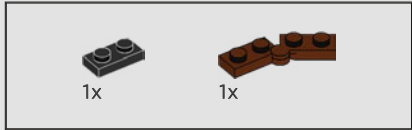
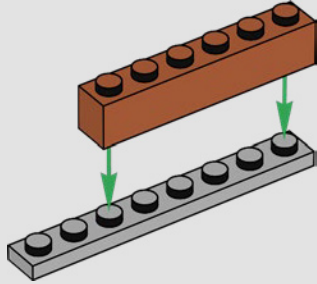

68

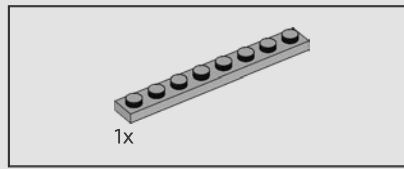
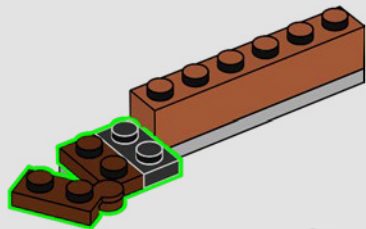

69

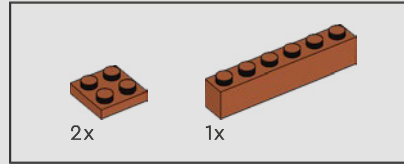
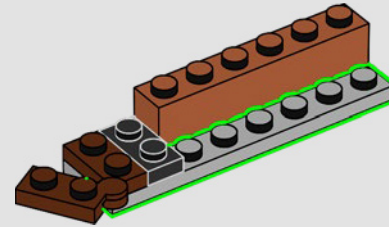

70

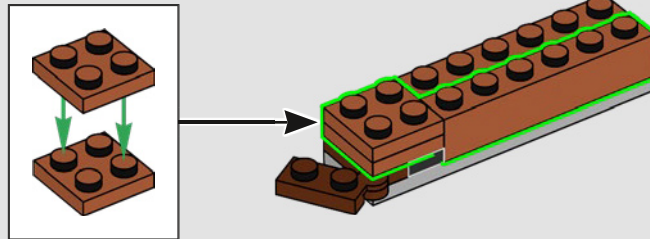

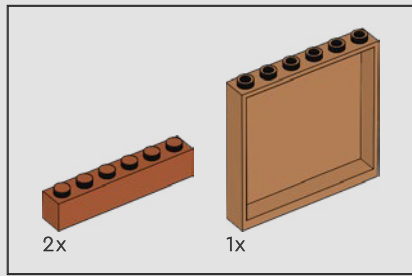

71

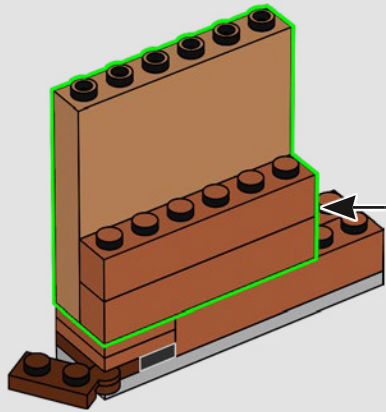
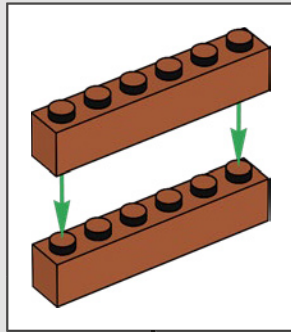

72

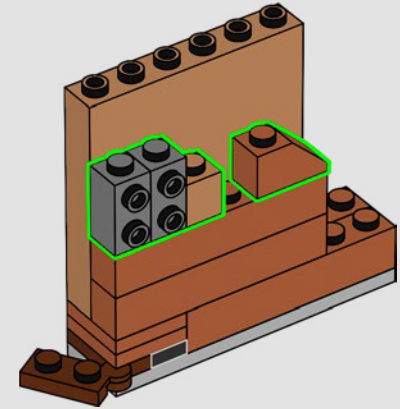

73

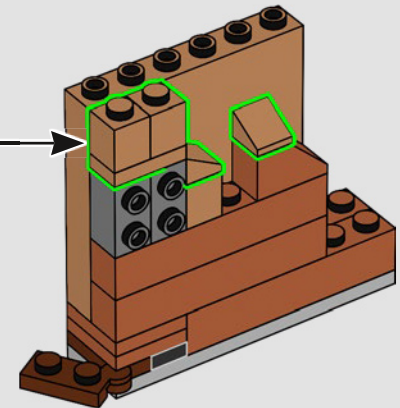
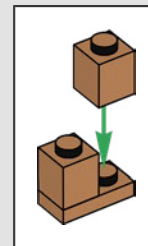

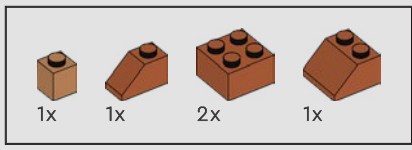

74

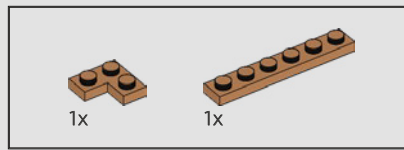
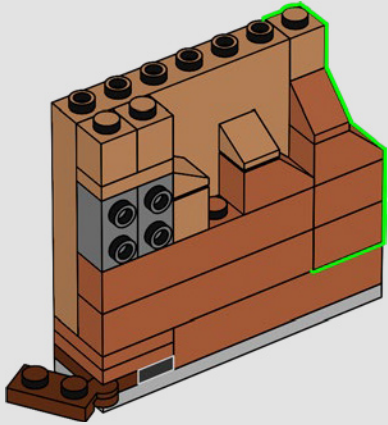
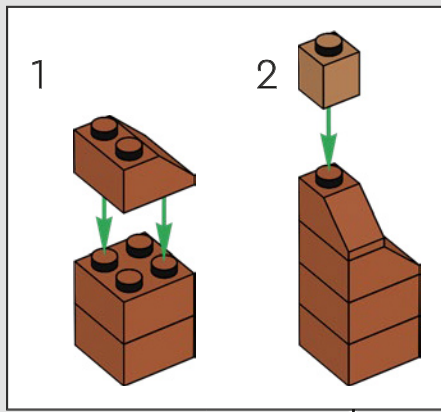

75

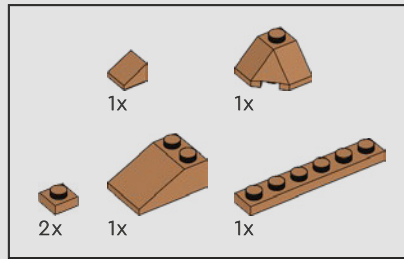
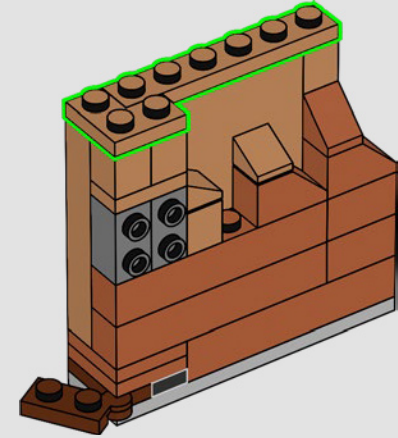

76

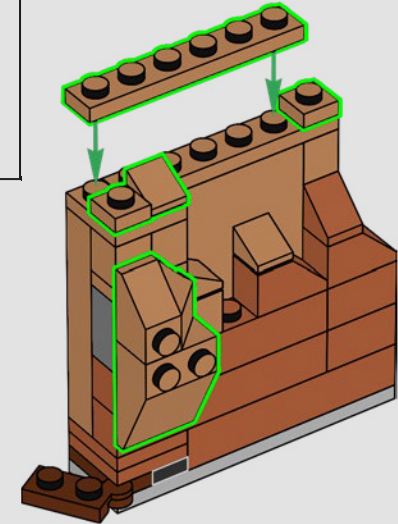

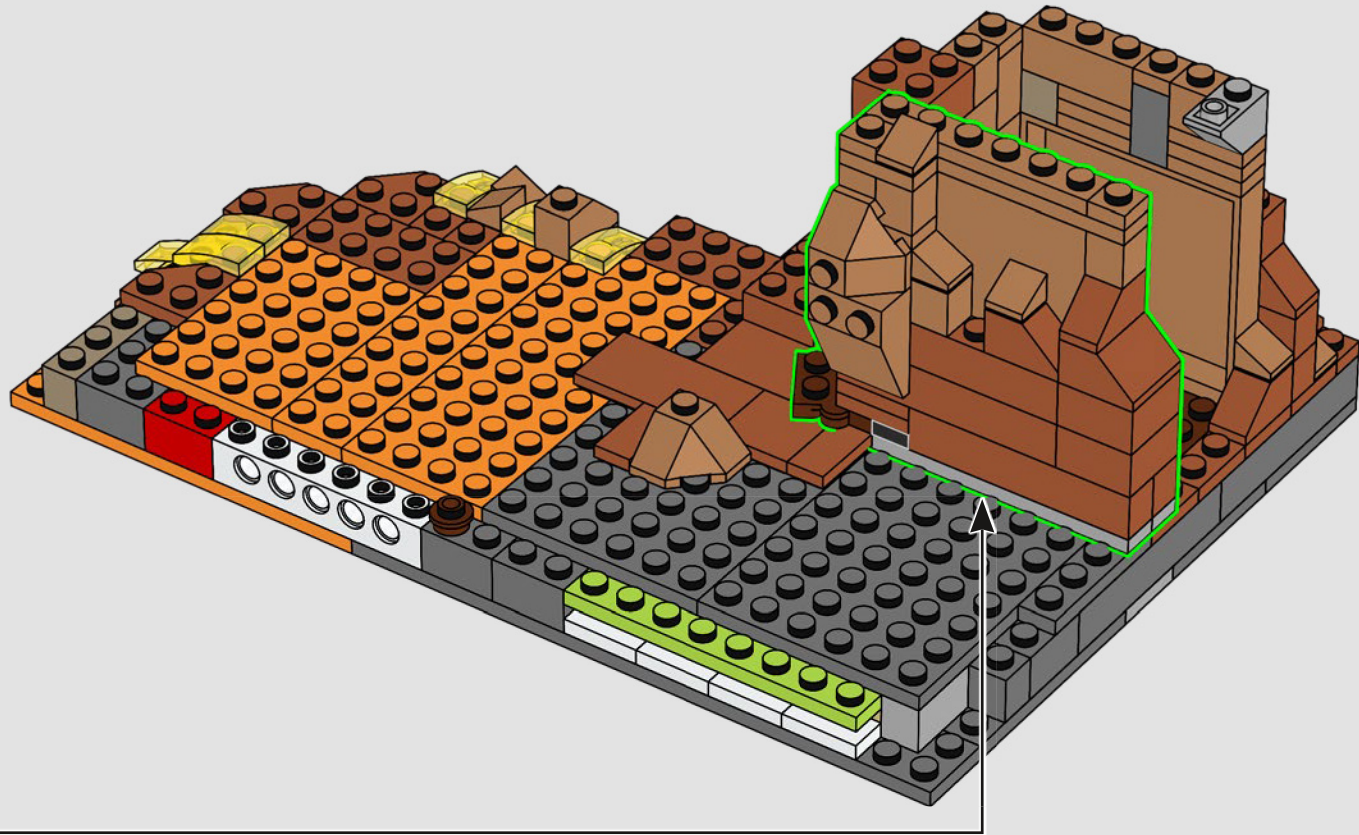

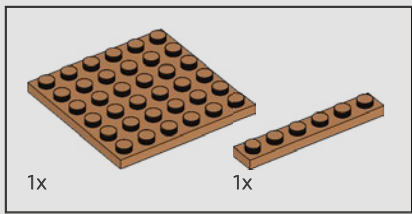

78

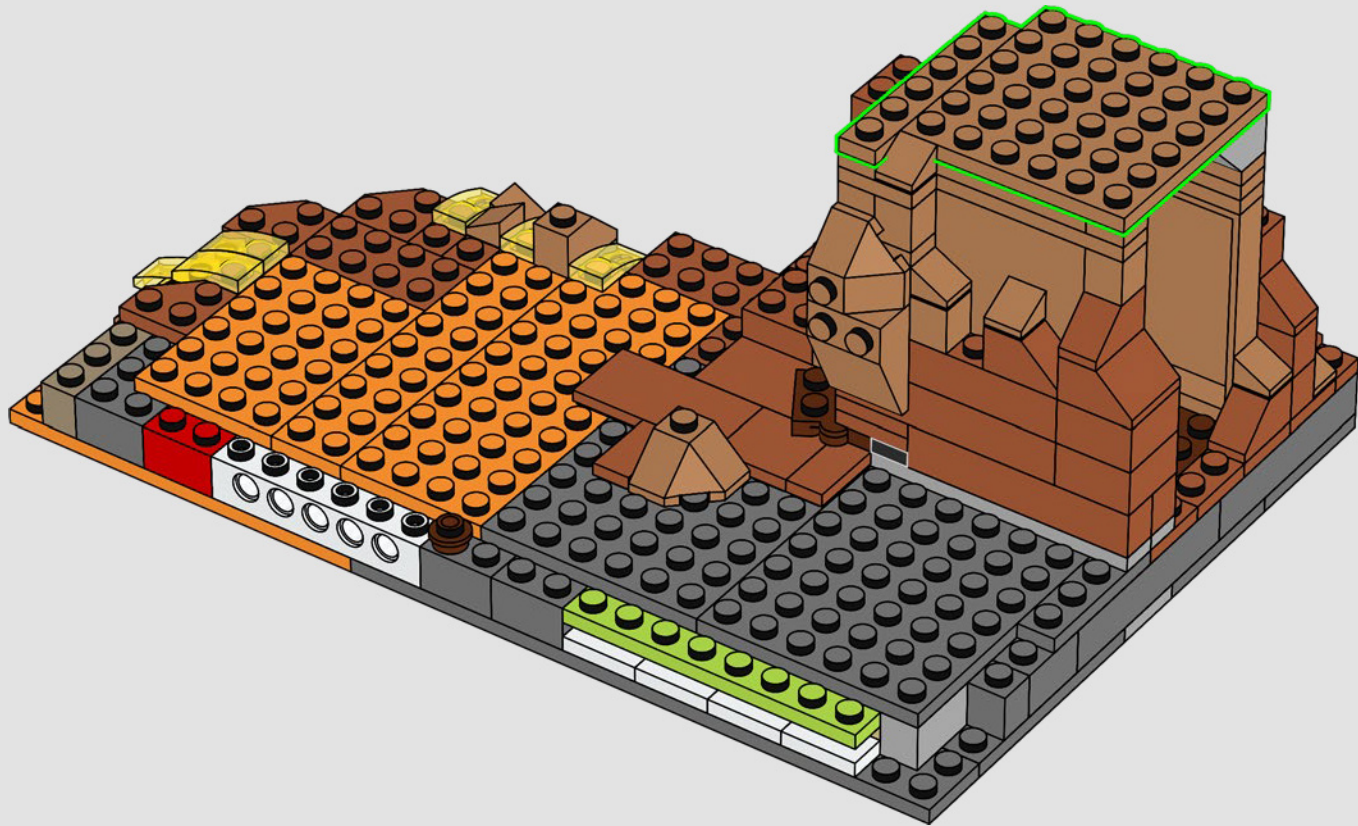

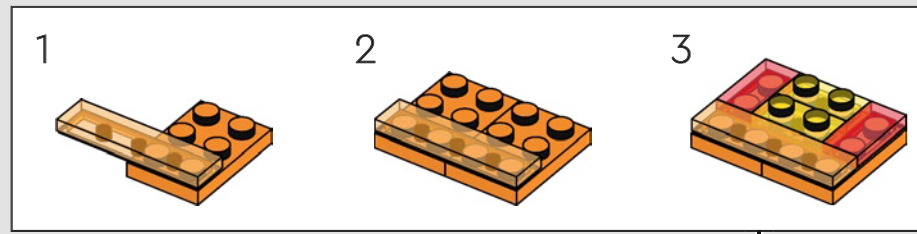
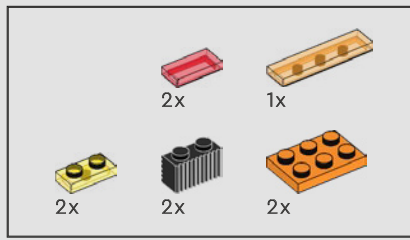

79

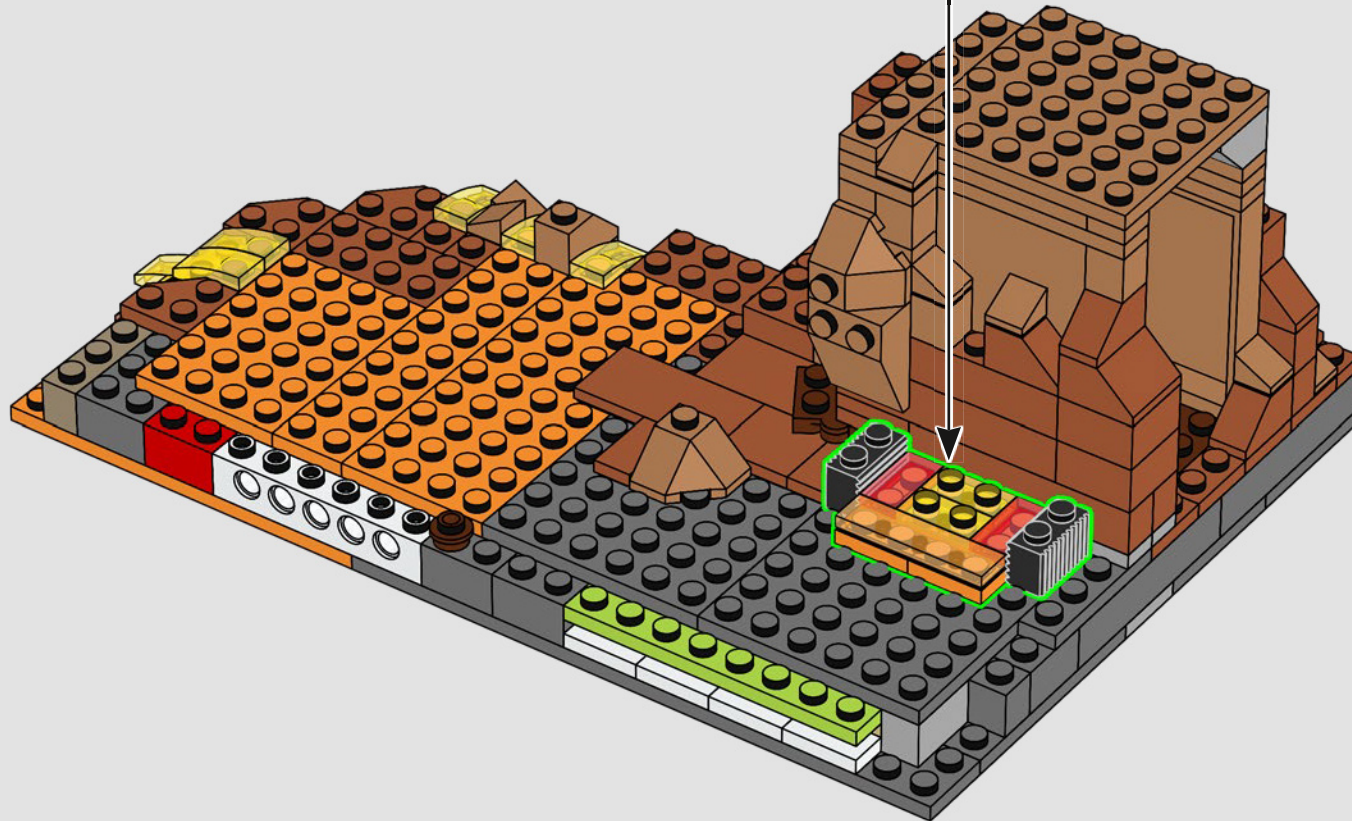

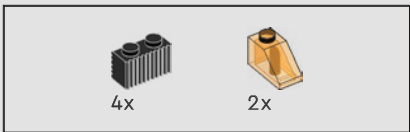

80

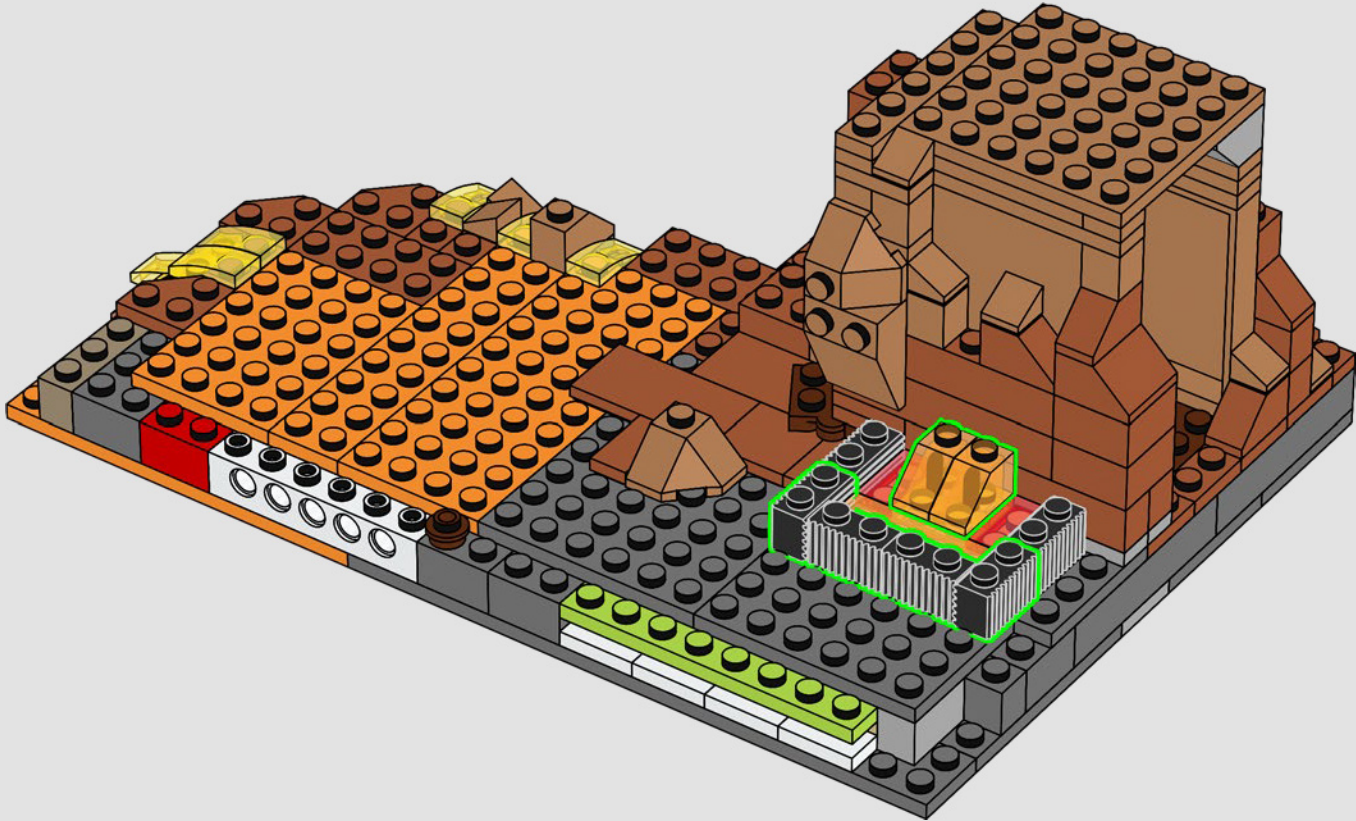

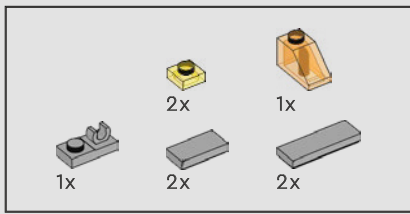

81

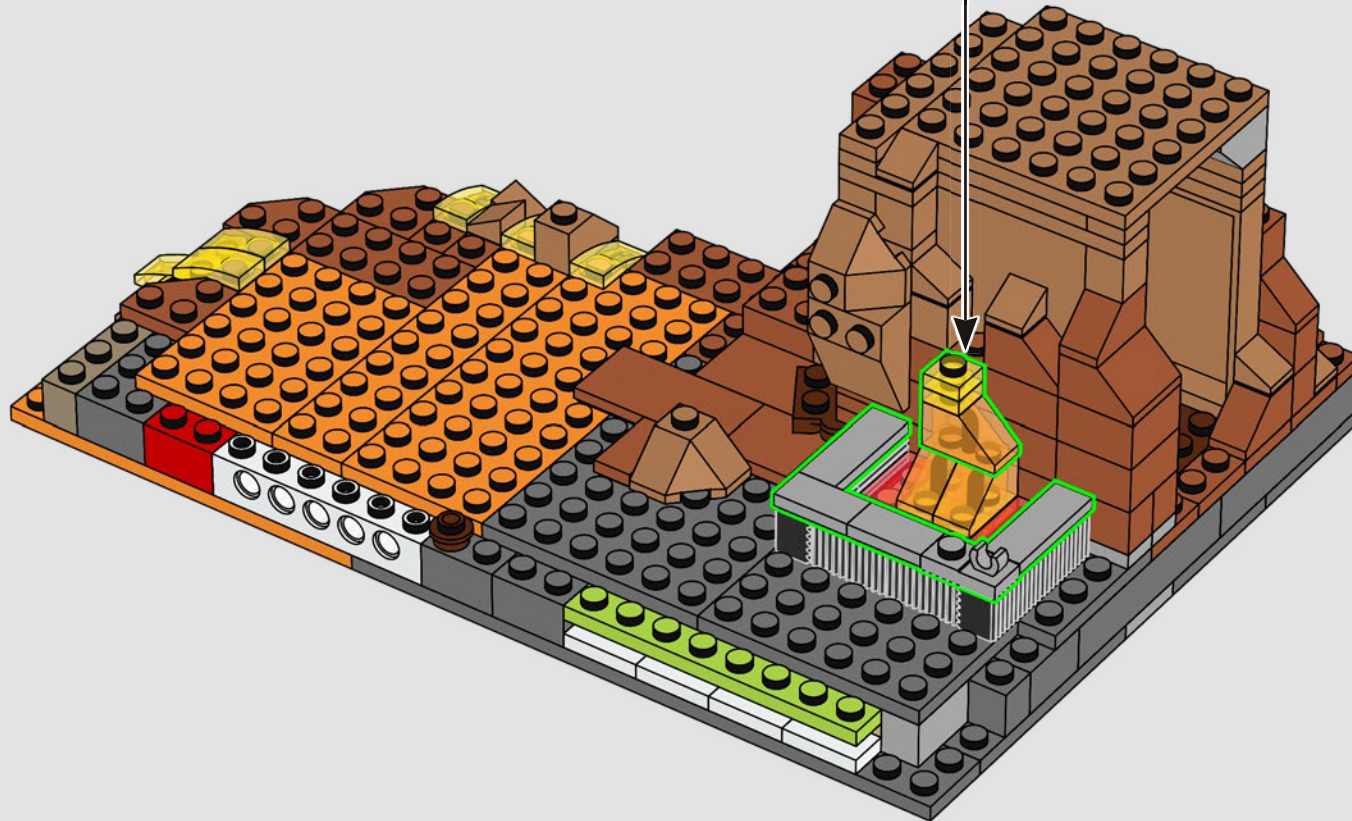
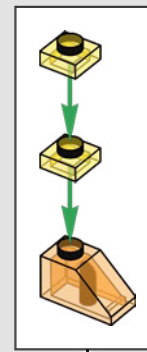



82

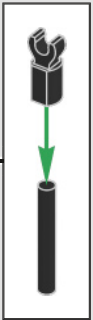
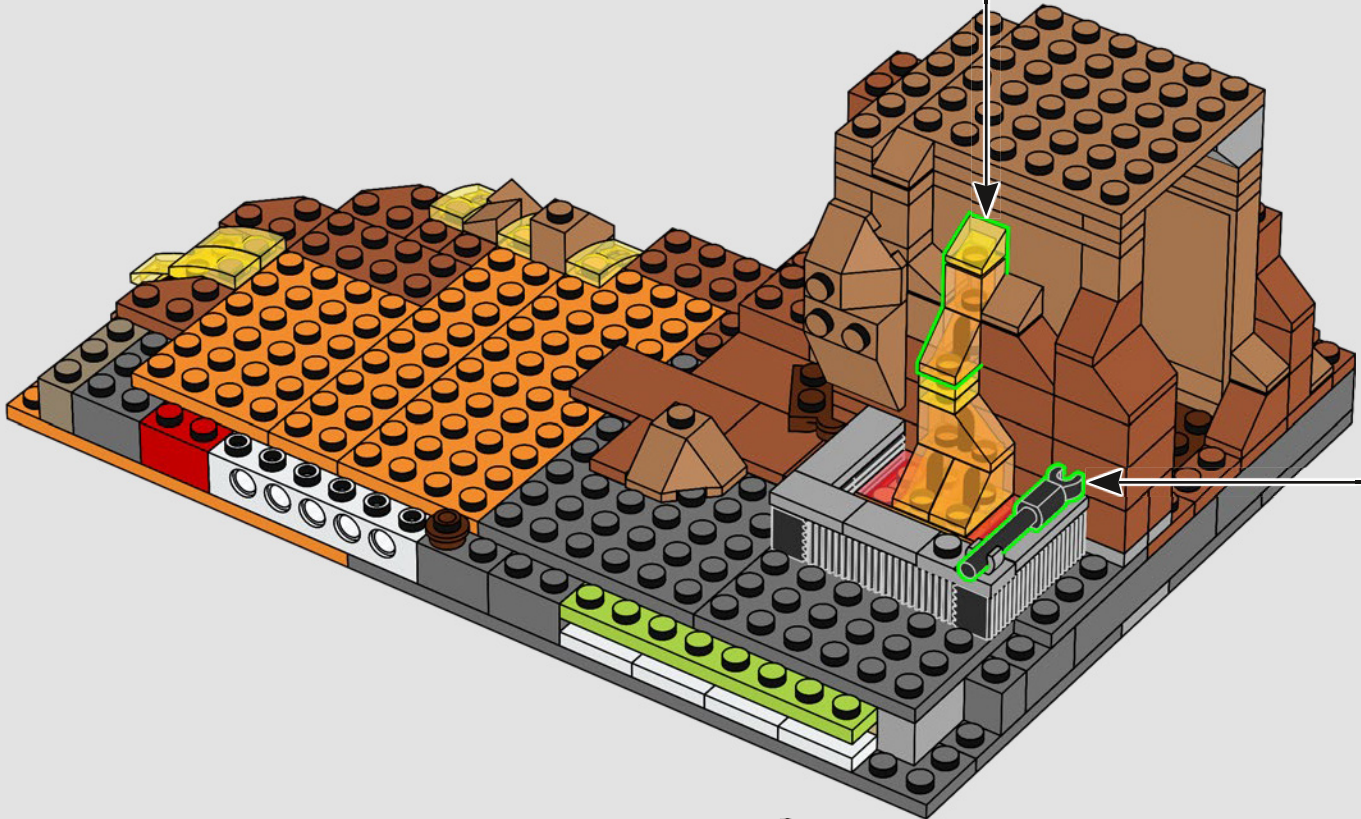
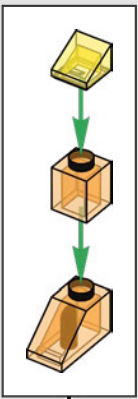

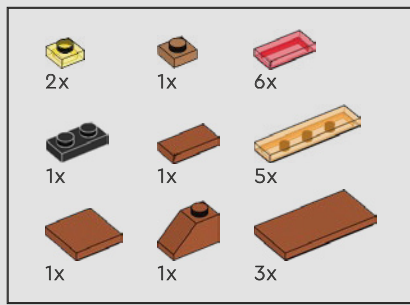

83

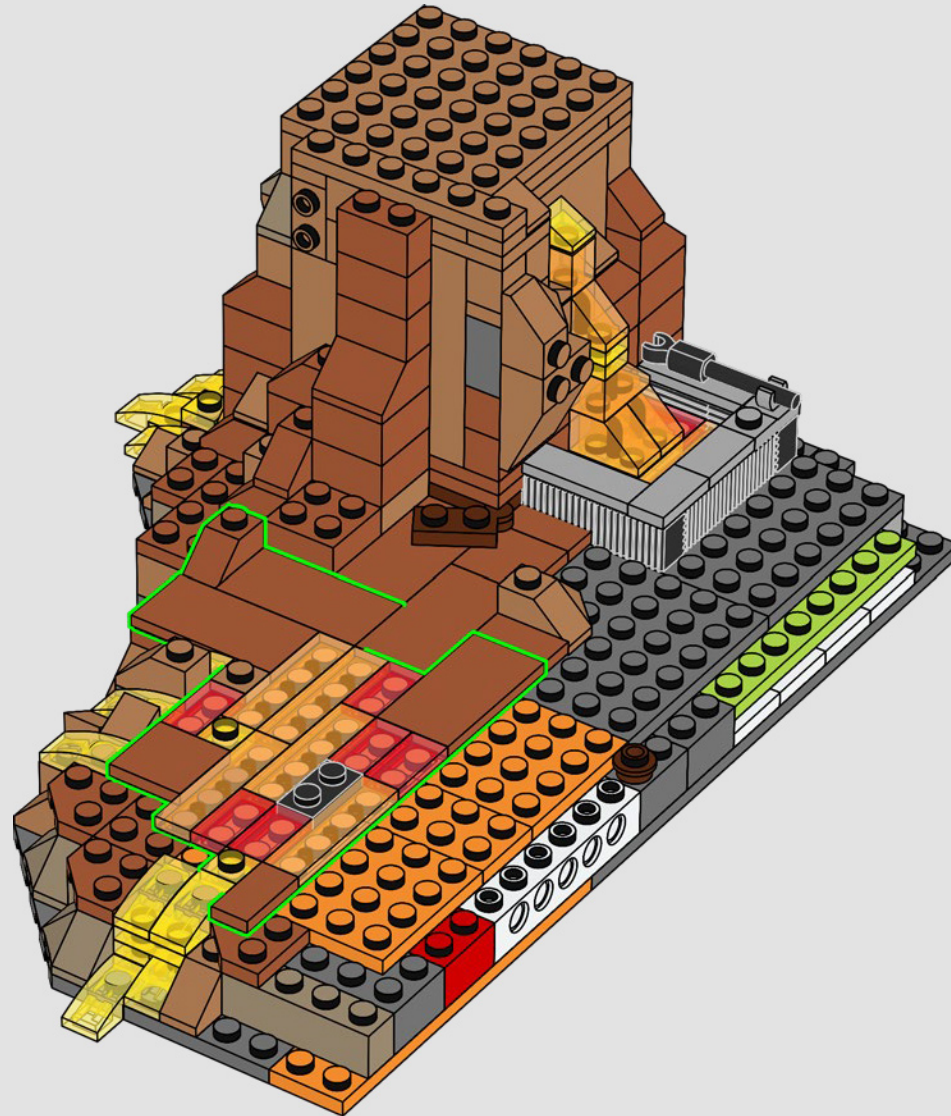

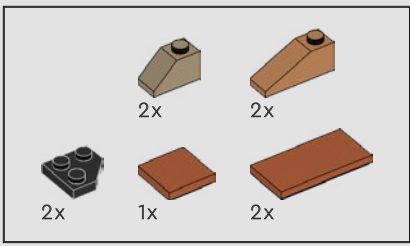

84

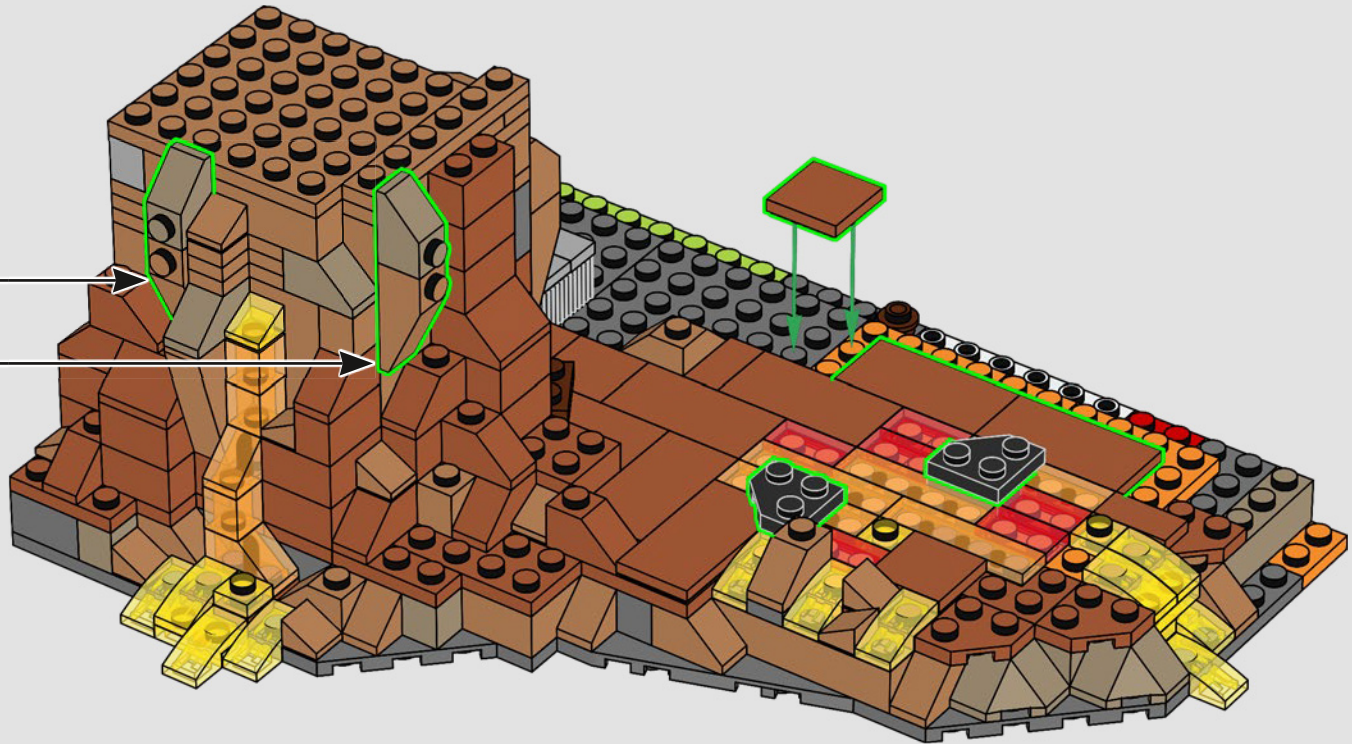
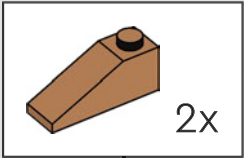

85



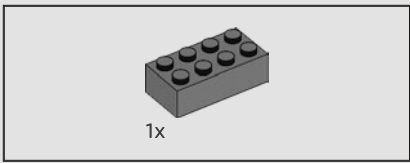

86

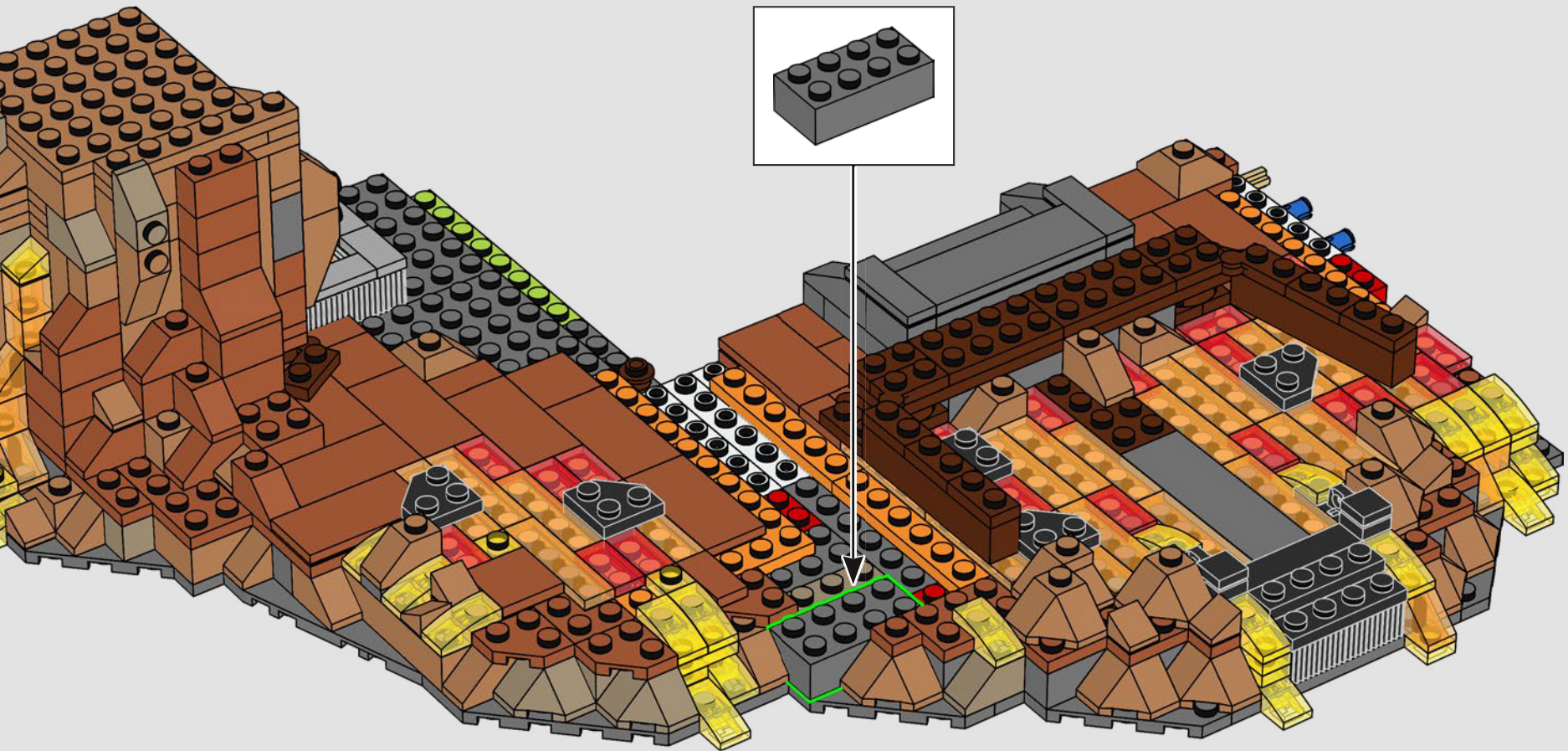

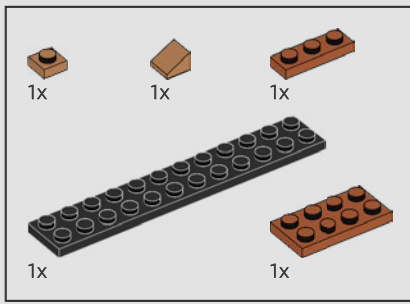

87

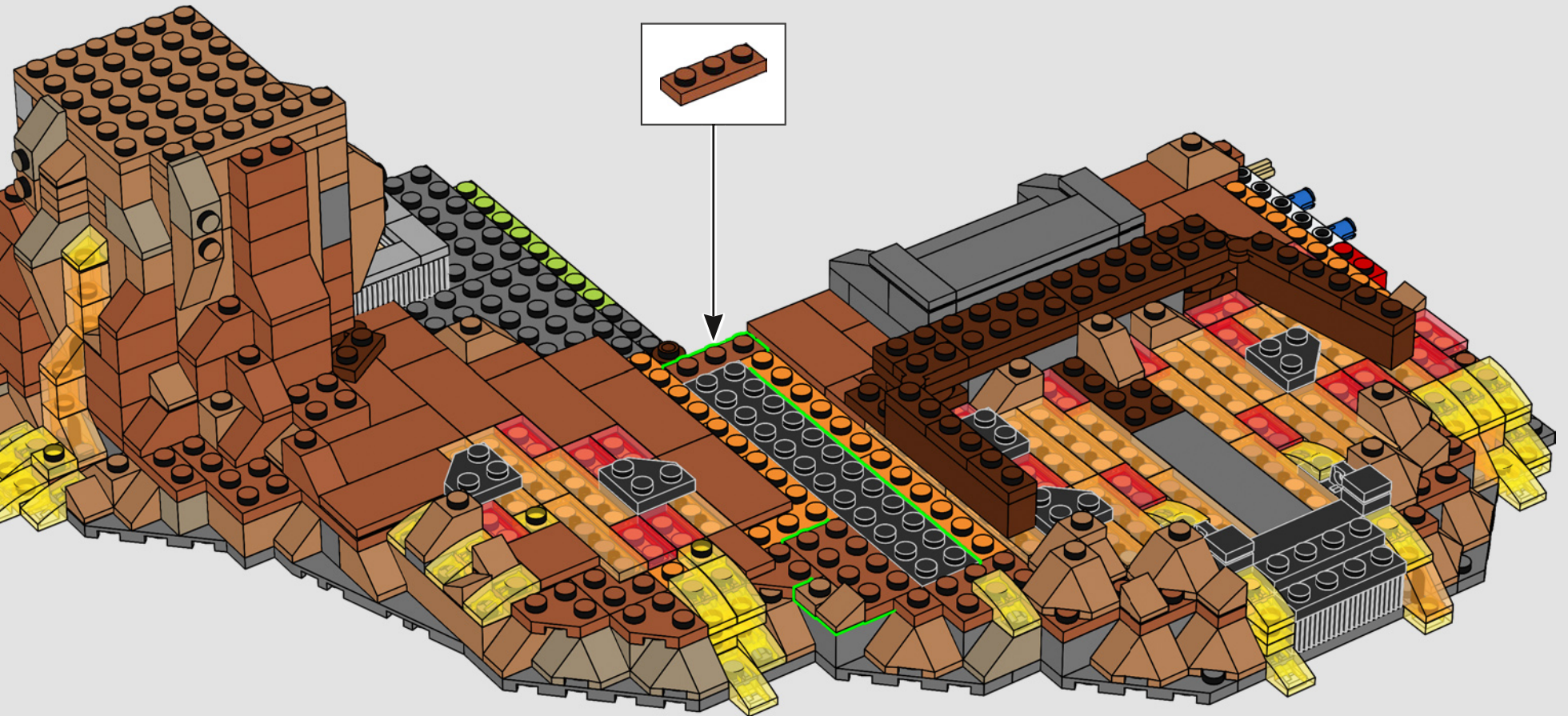



„Es gibt etwas Gutes in dieser Welt, Herr Frodo,
und dafür lohnt es sich zu kämpfen.“ – Samweis Gamschie

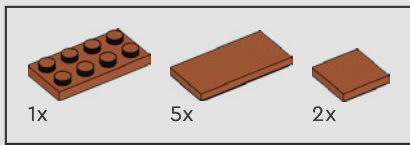

88

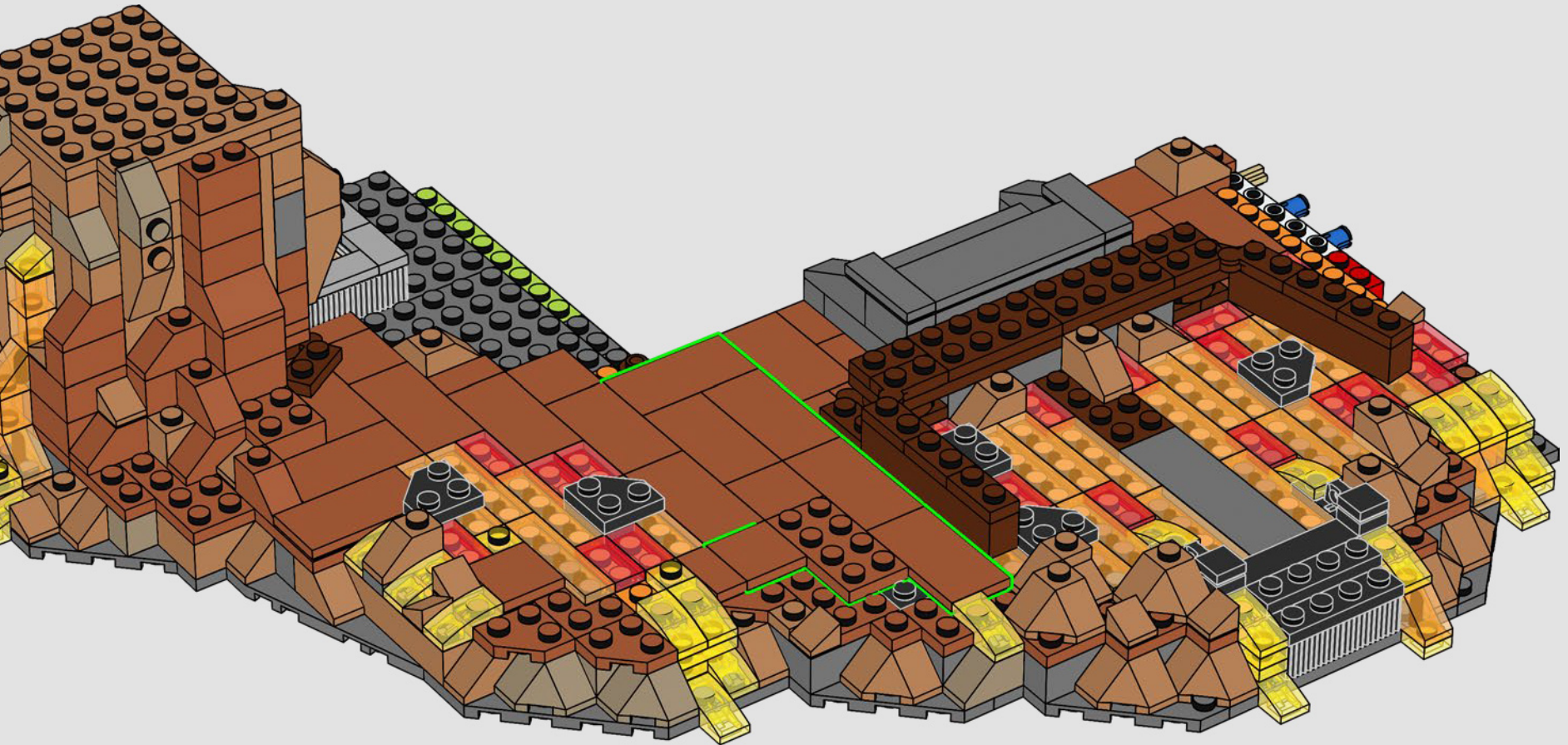

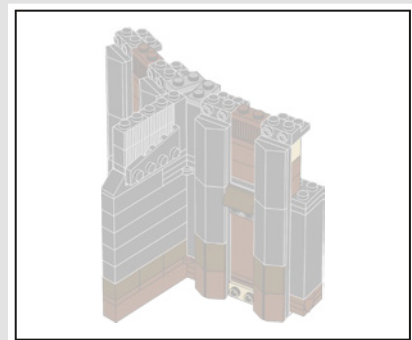

89

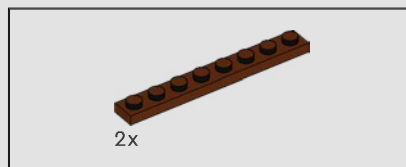
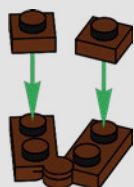

90

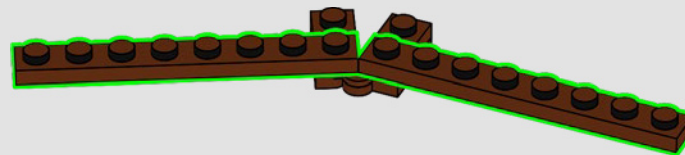

91

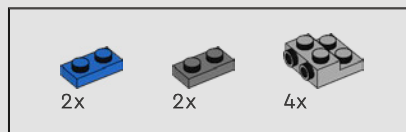
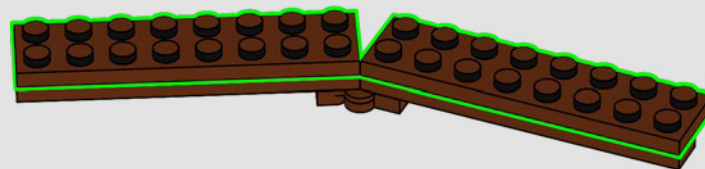

92

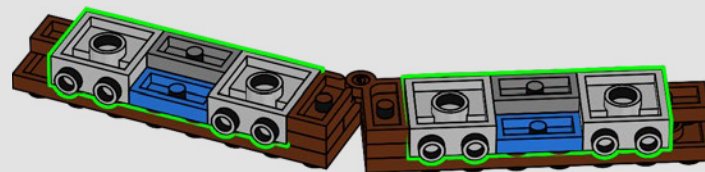



93



94

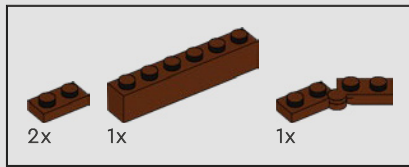
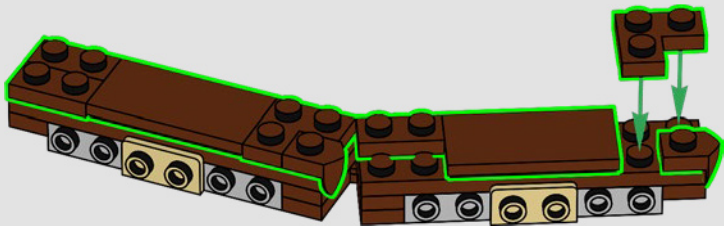

95

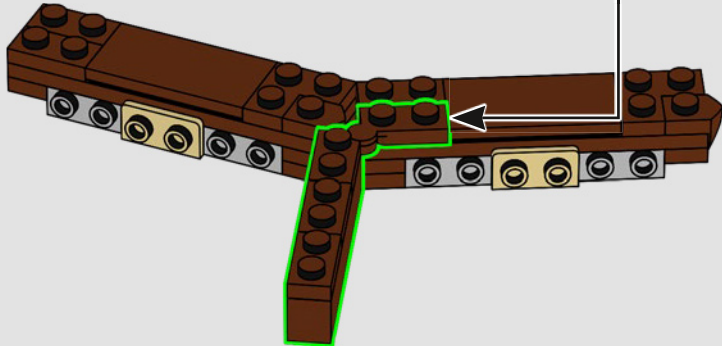
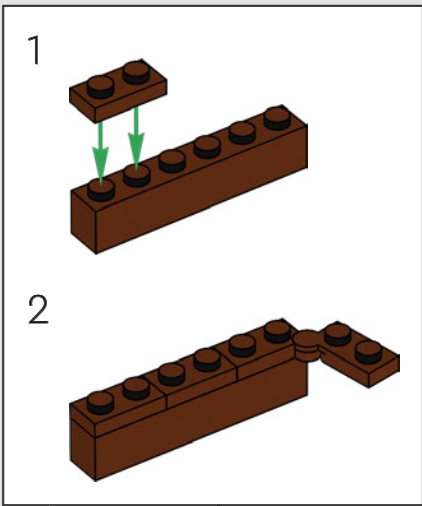

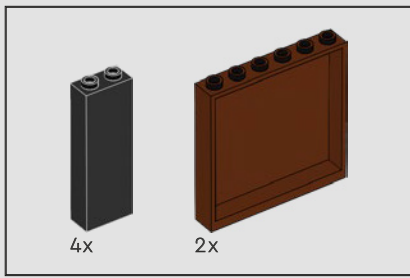

96

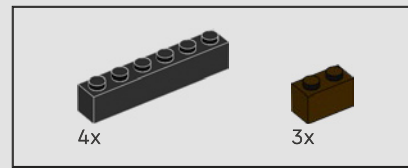
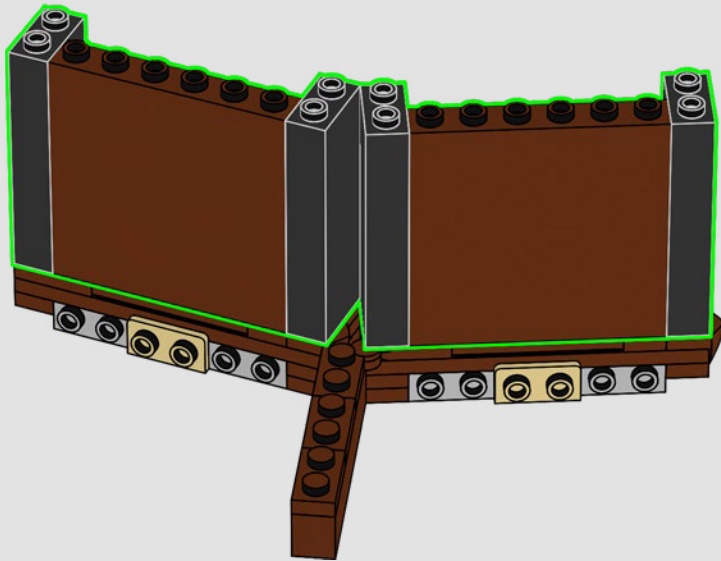

97

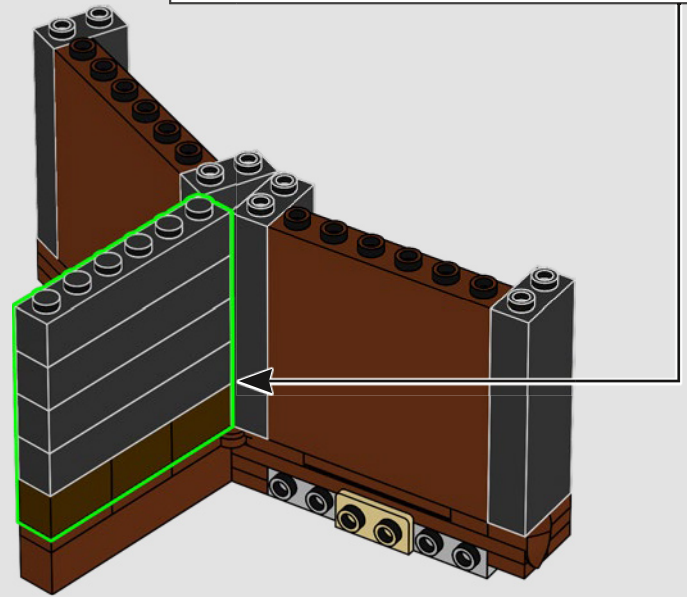
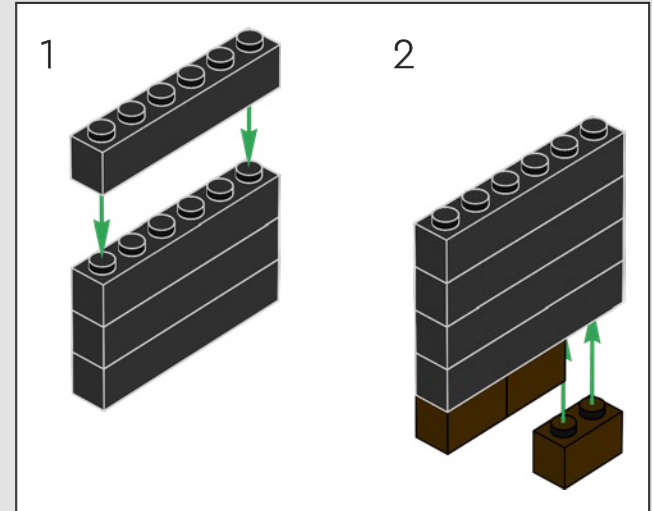

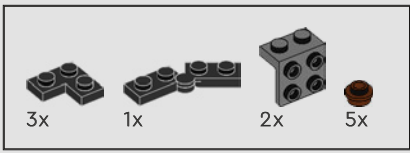

98

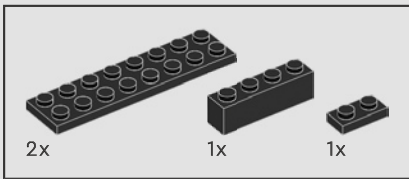
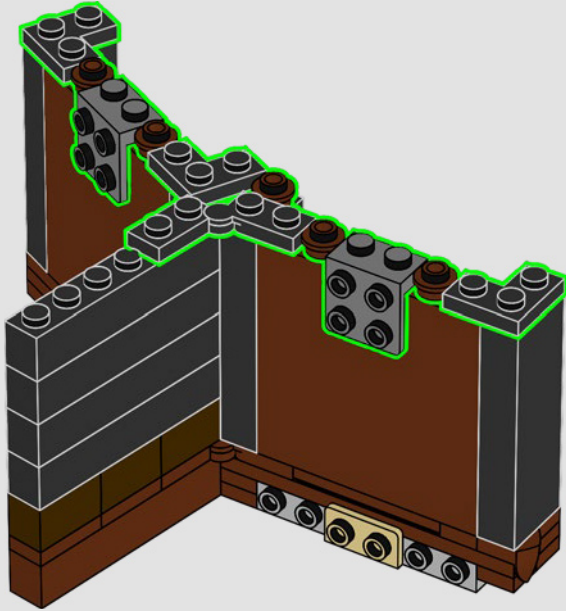

99

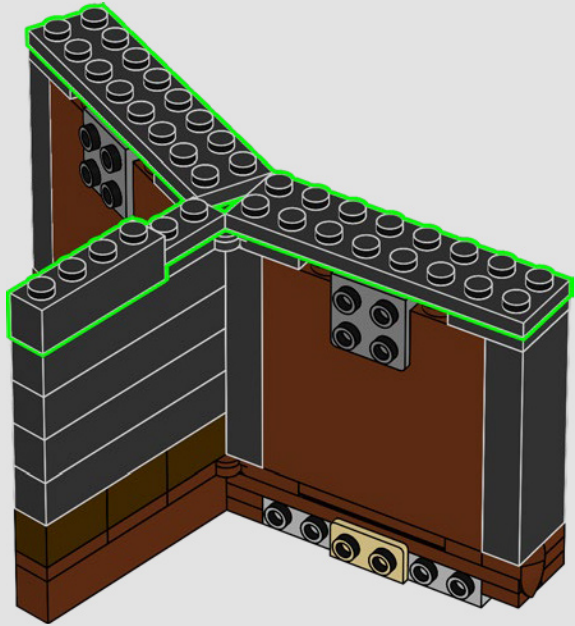

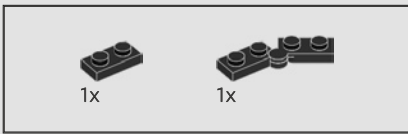

100

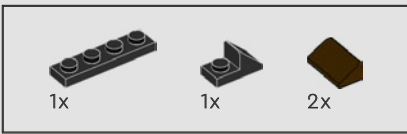
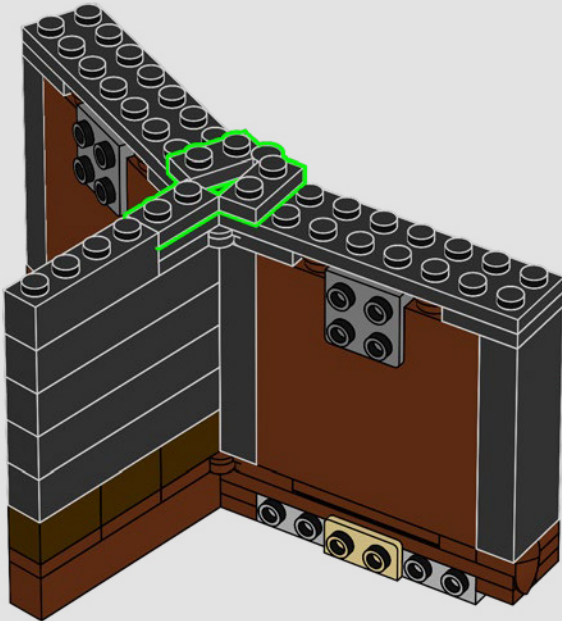

101

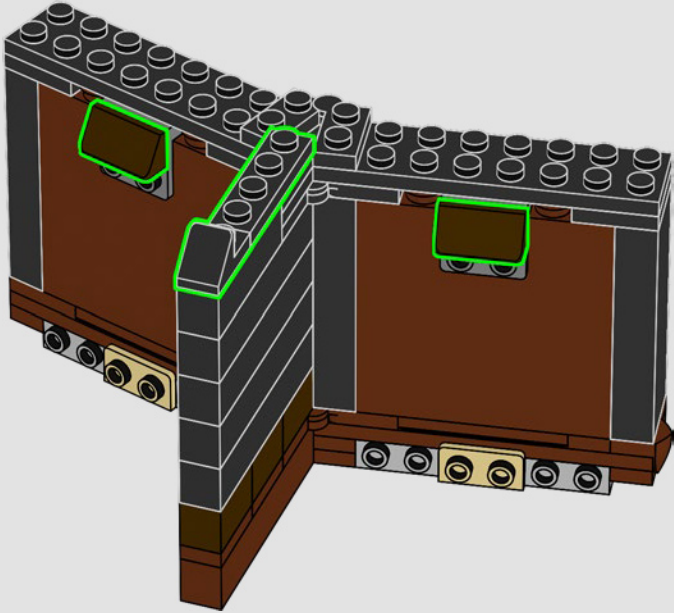

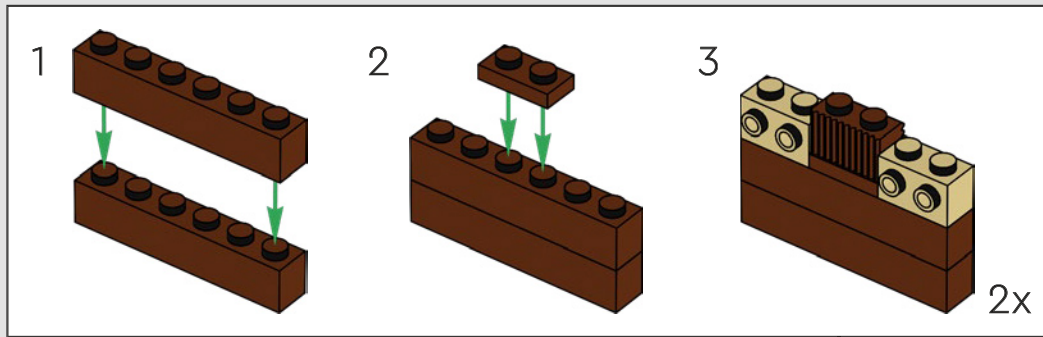
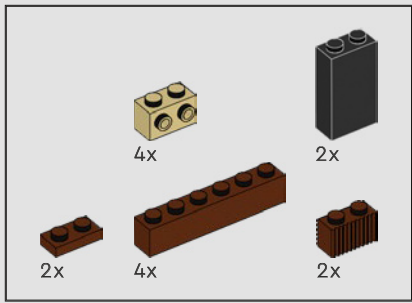

102

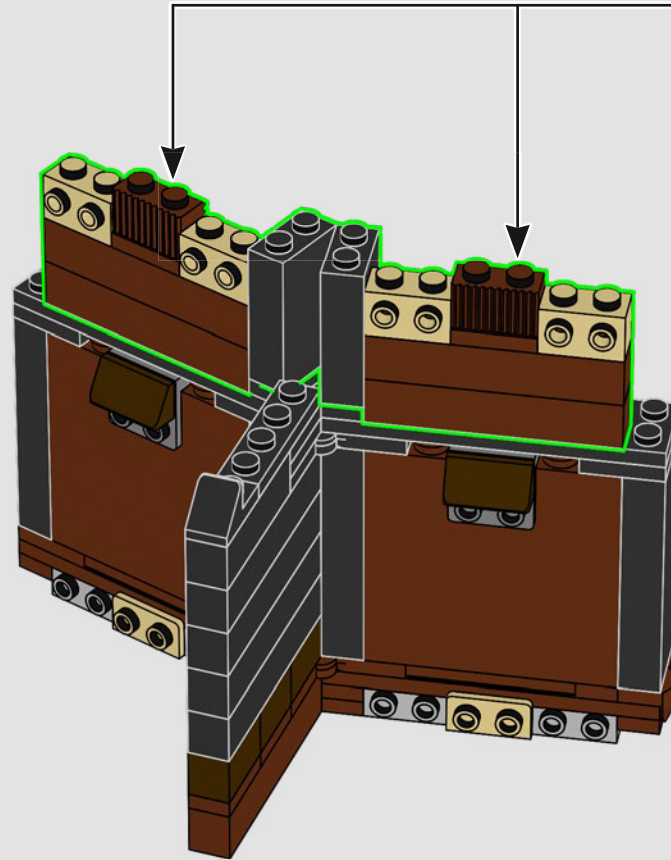

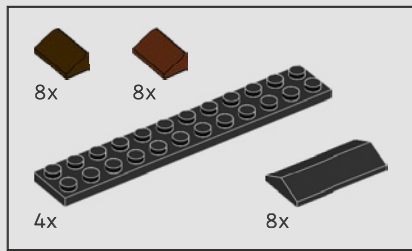

103

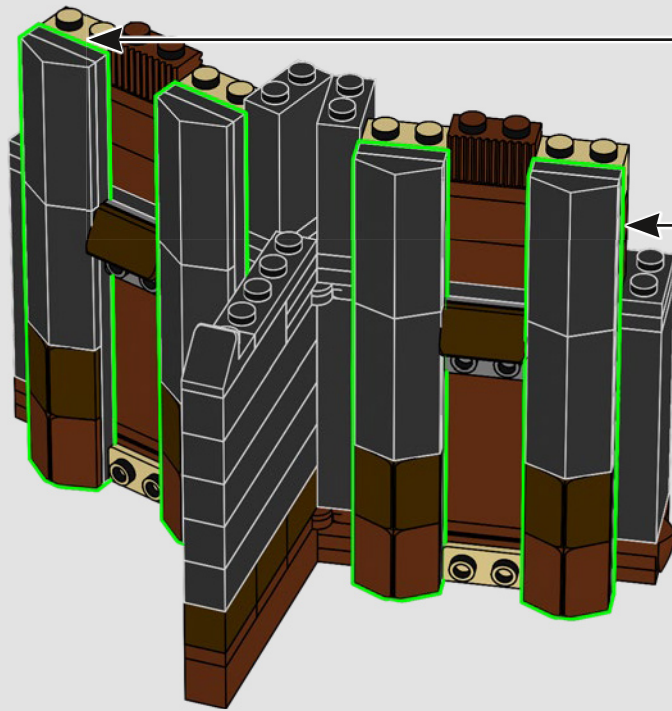
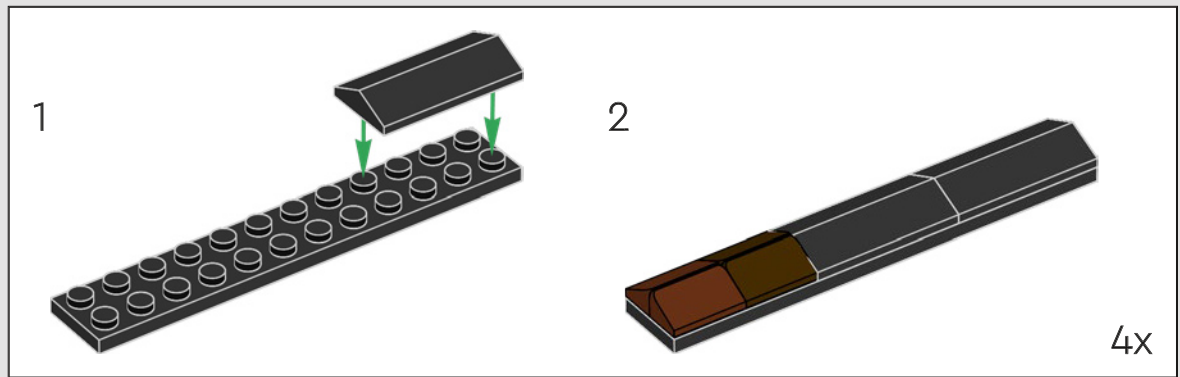



„Man kann nicht einfach nach Mordor spazieren. Seine schwarzen Tore werden von Schlimmerem bewacht als Orks.“ – Boromir

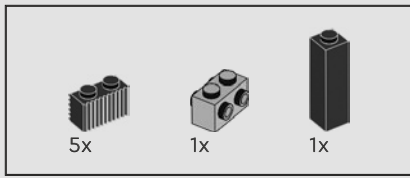

104

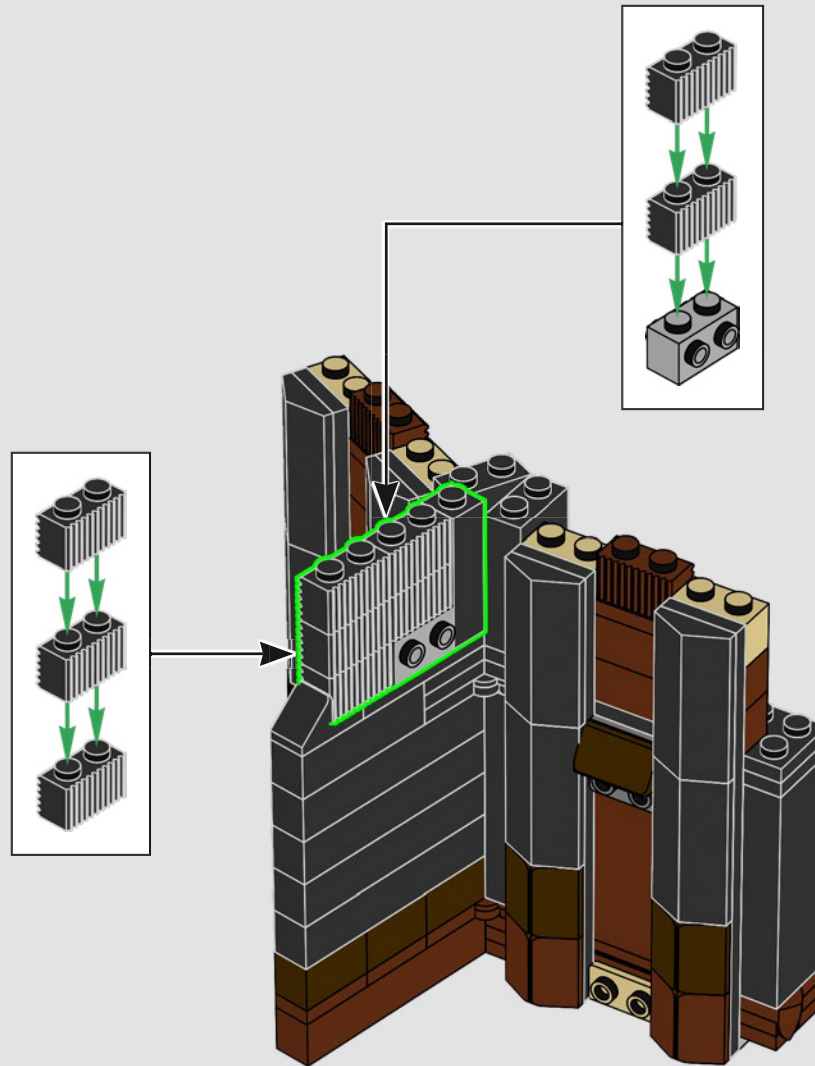

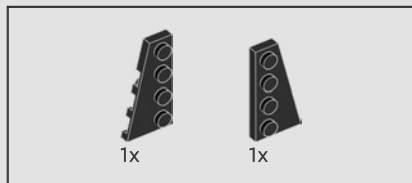

105

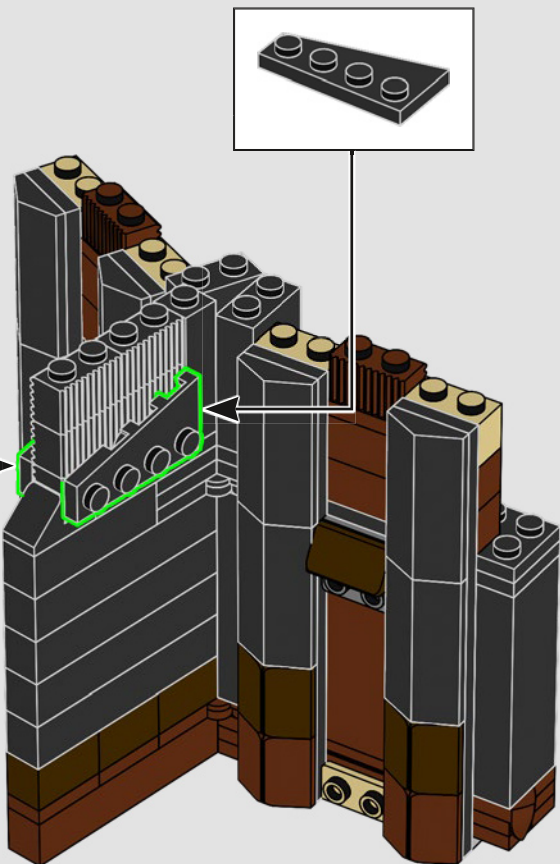
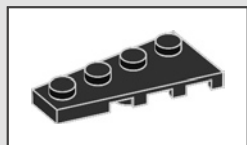

106

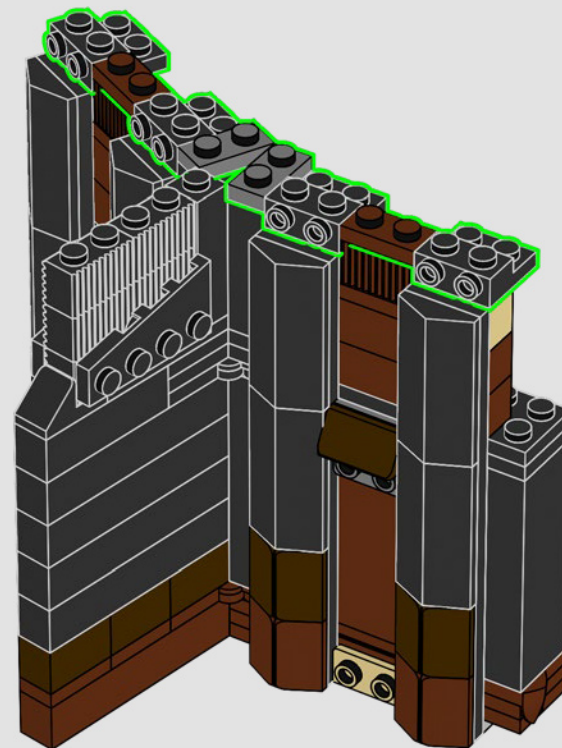

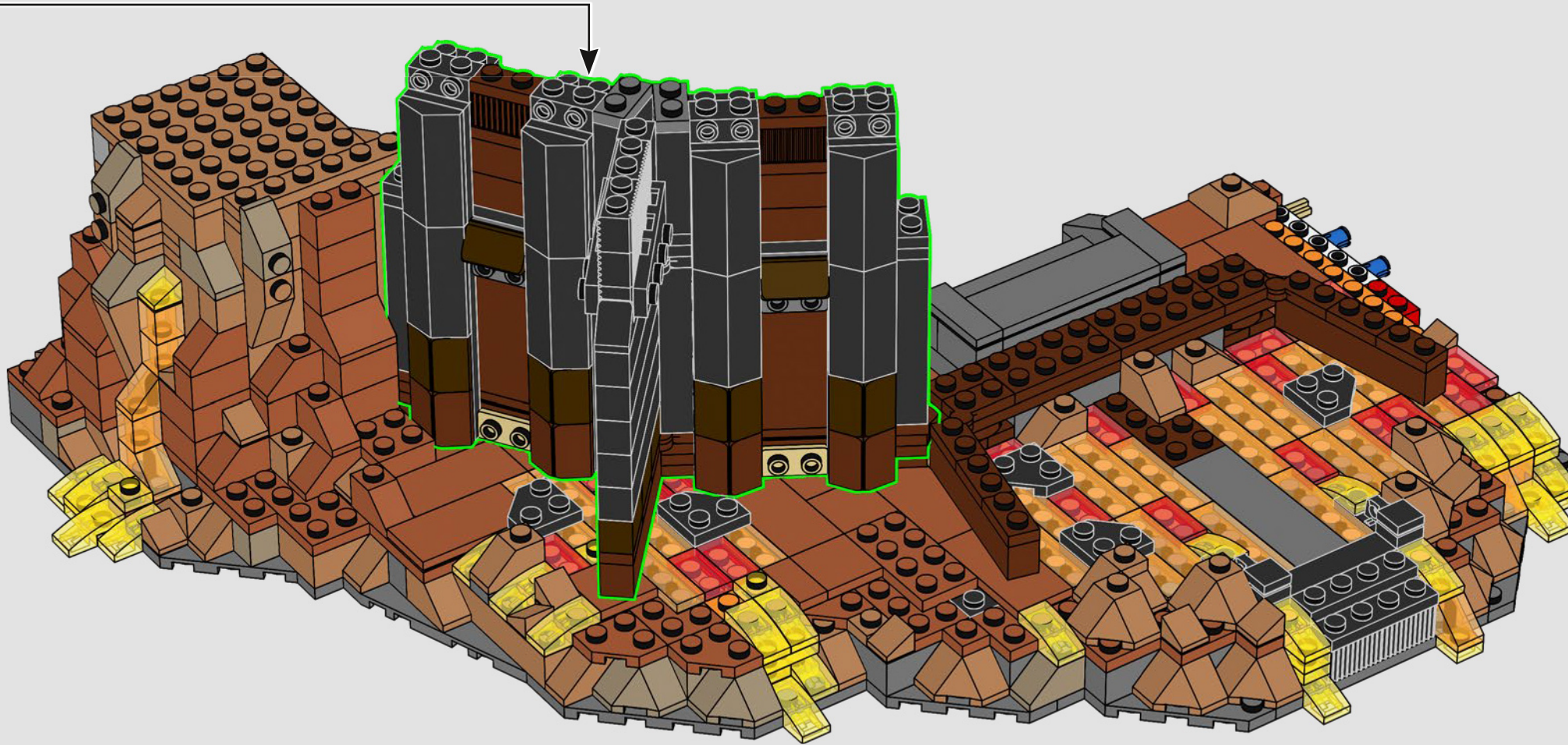

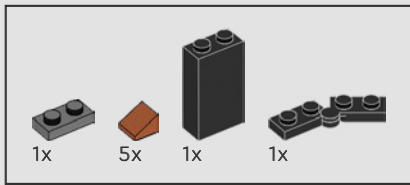

108

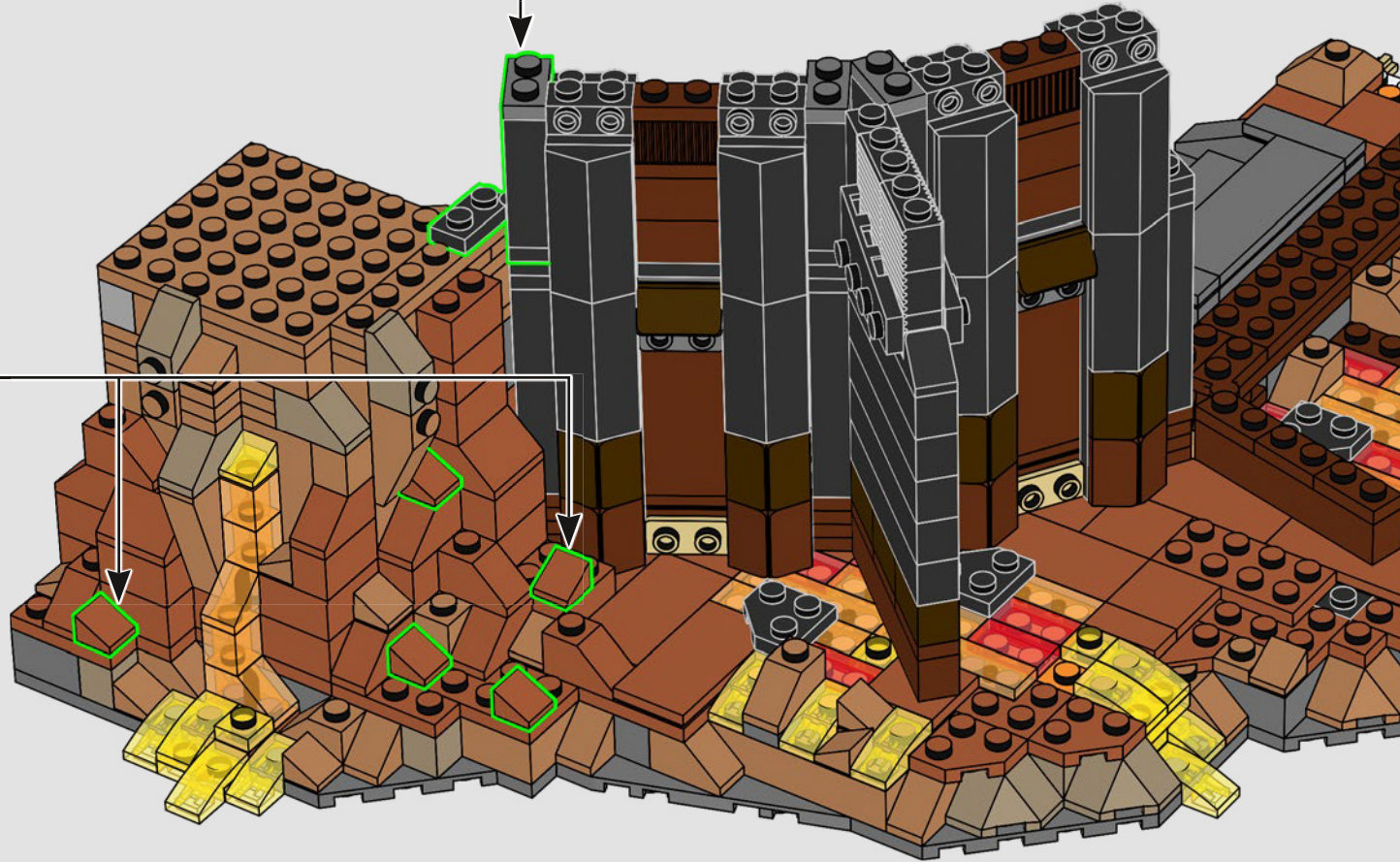
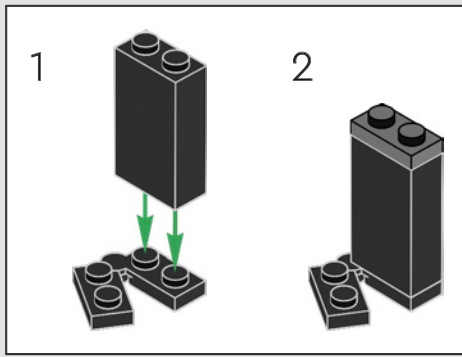



109

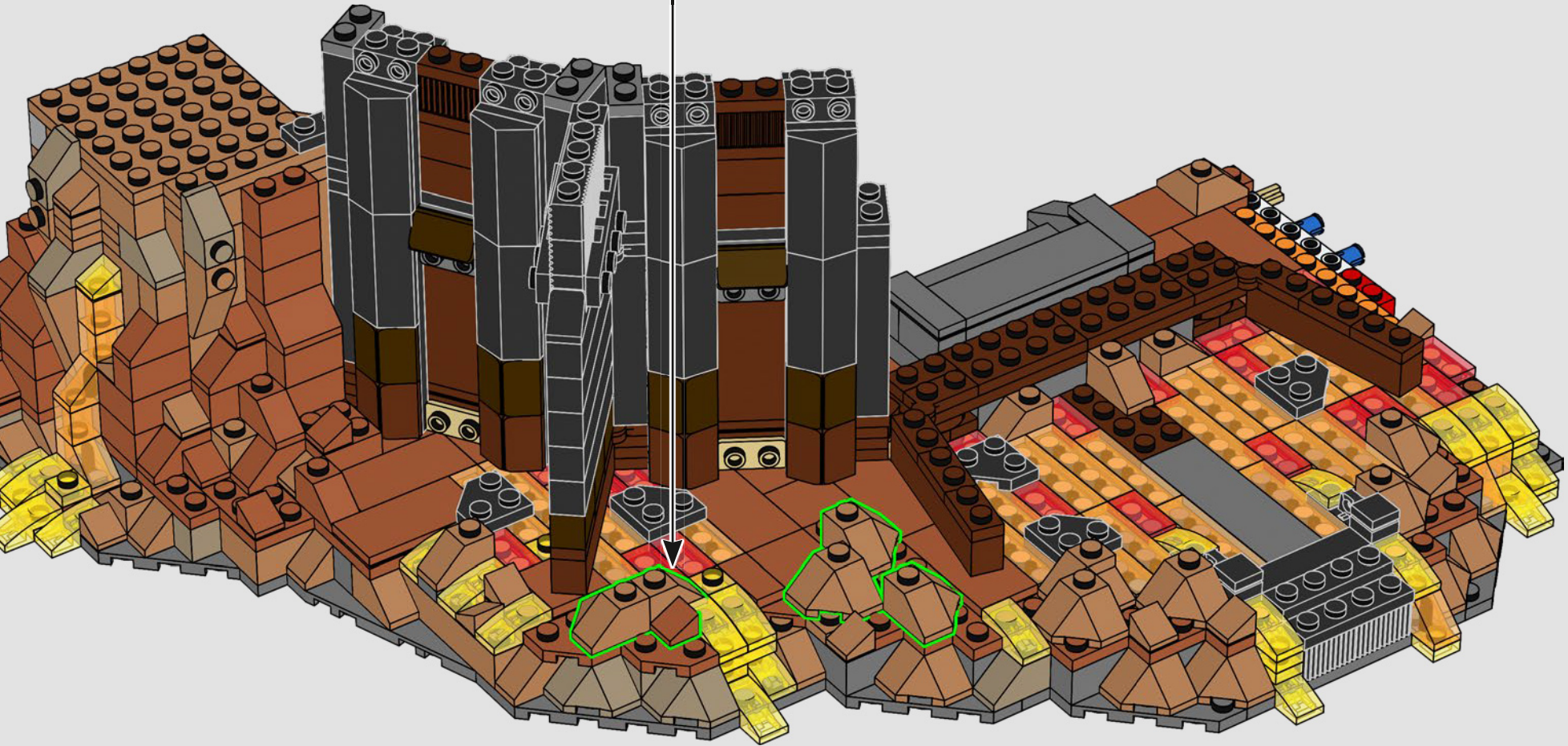
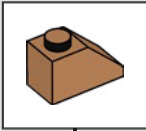

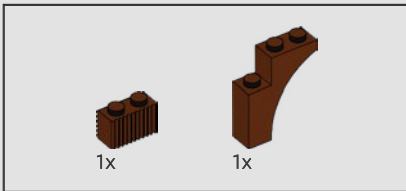
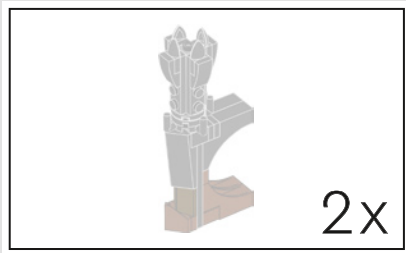

110

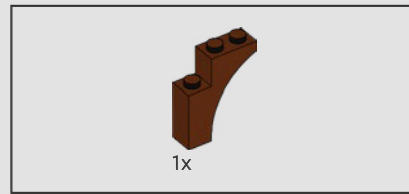
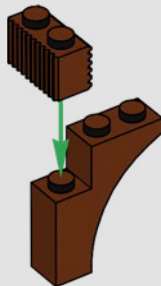

111

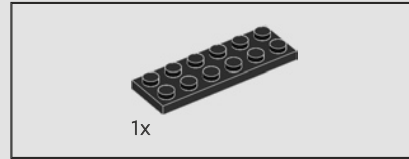
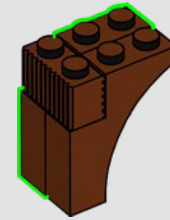

112

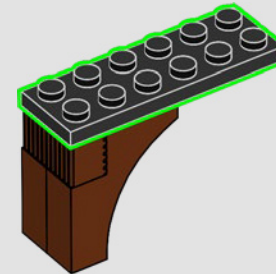



113

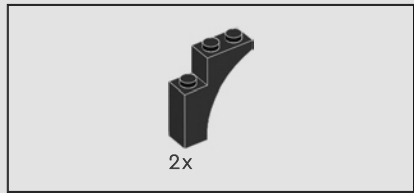
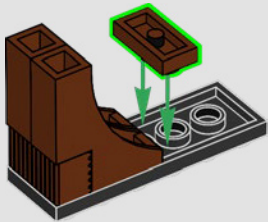

114

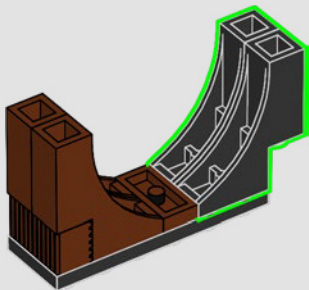

115

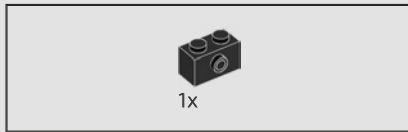
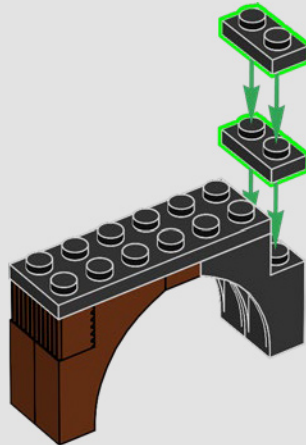

116

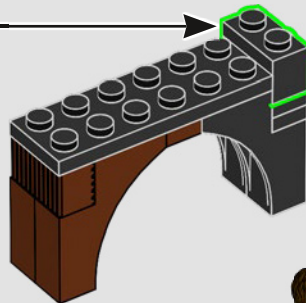
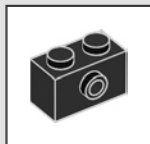

117

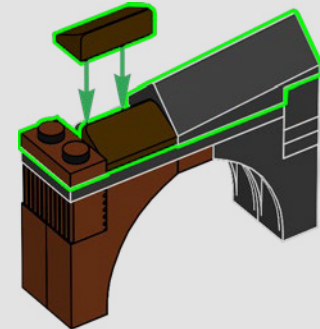

118

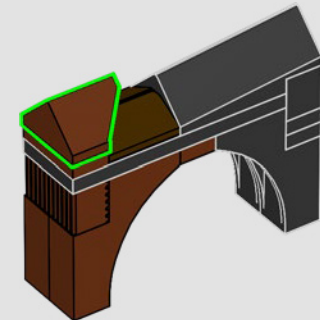

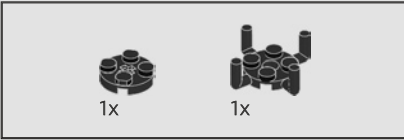
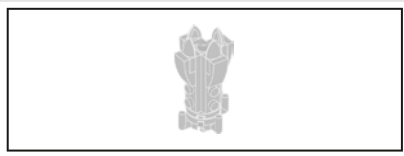

119

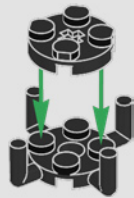

120

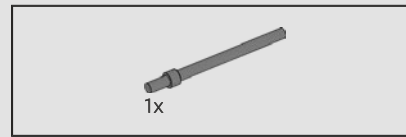
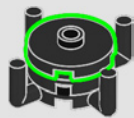

121

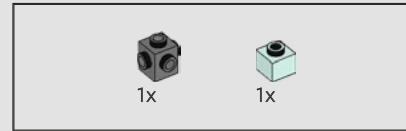
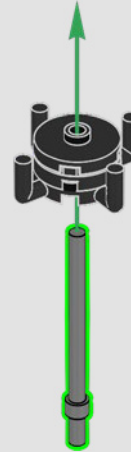

122

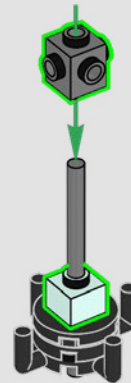



123

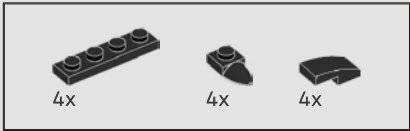
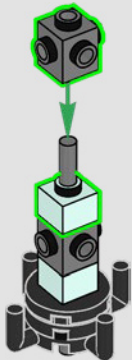

124

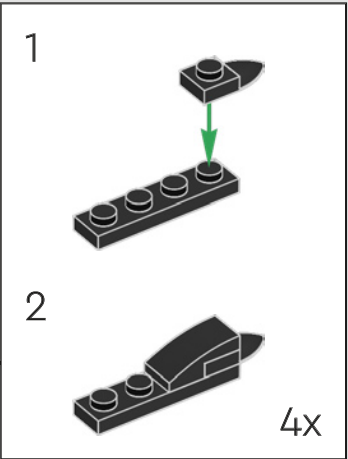

125

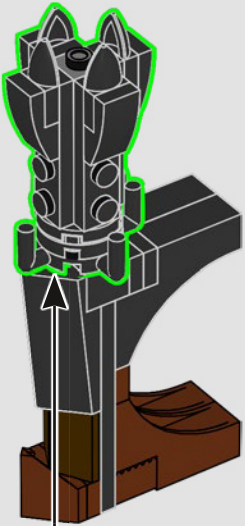

2x





Die Farbabstufungen verleihen der dunklen und spitzkantigen Architektur des Turms ein majestätisches und dynamisches Erscheinungsbild.

126

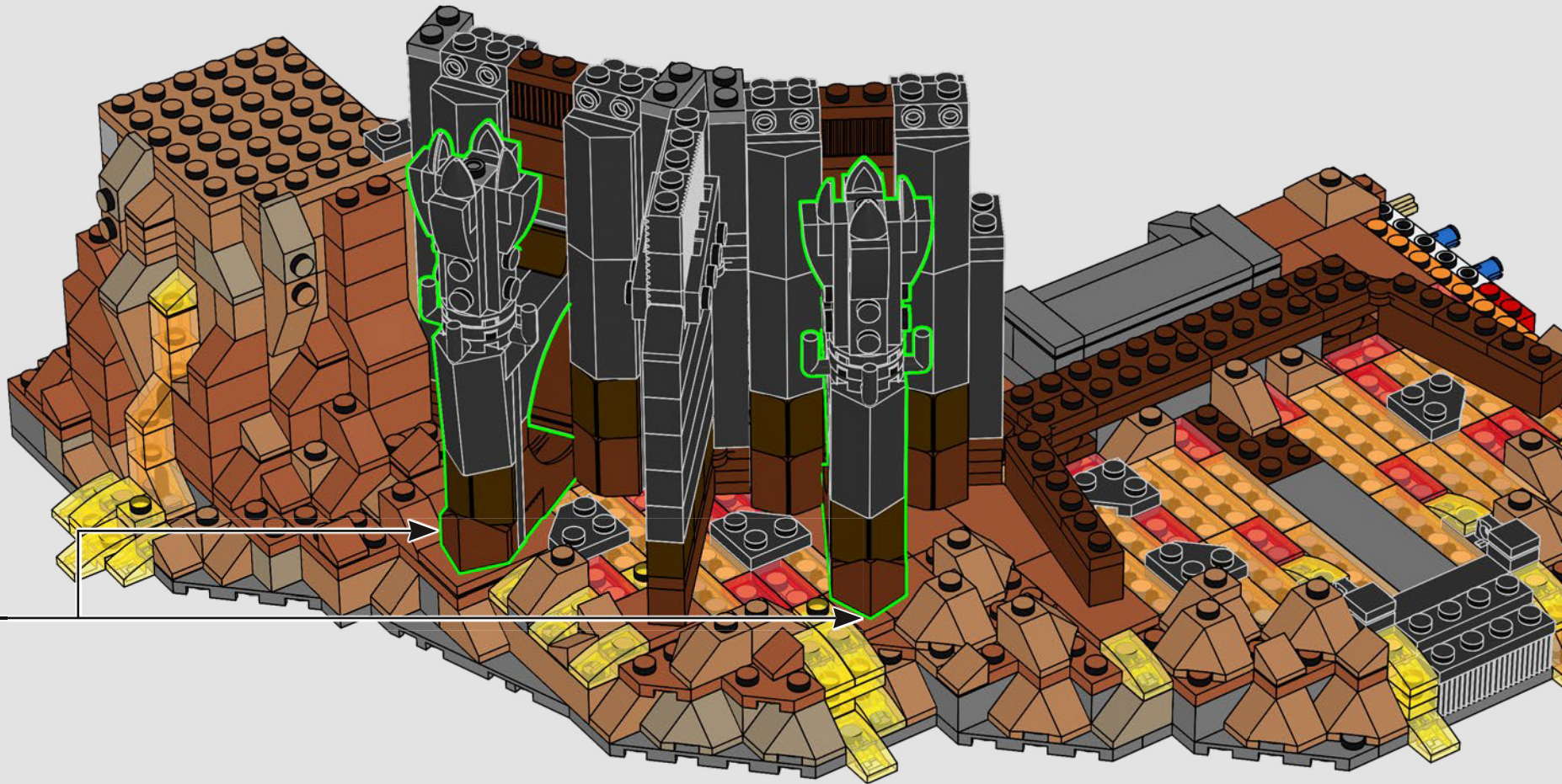

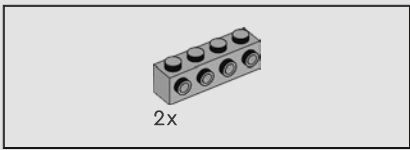

127

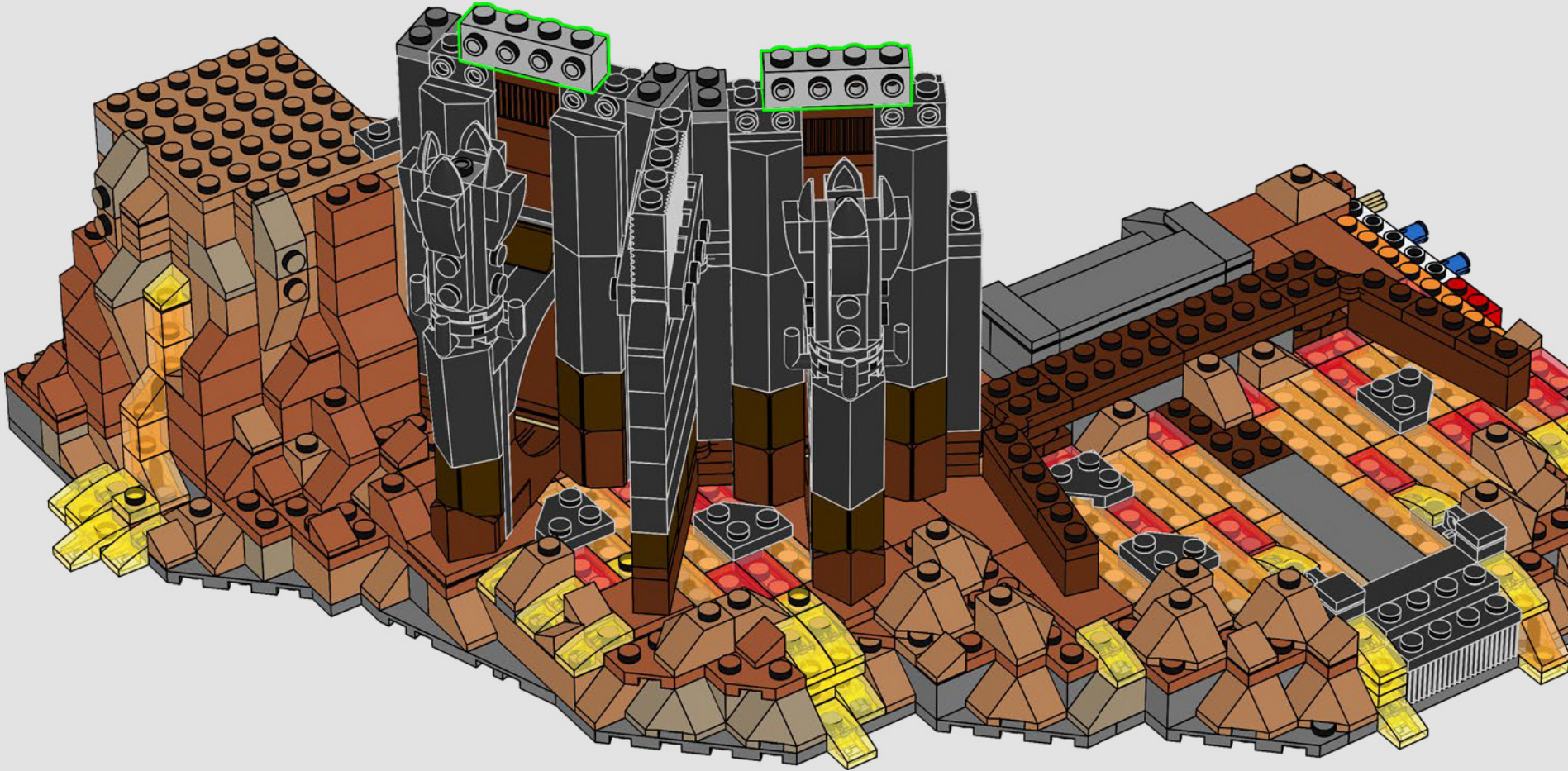



128

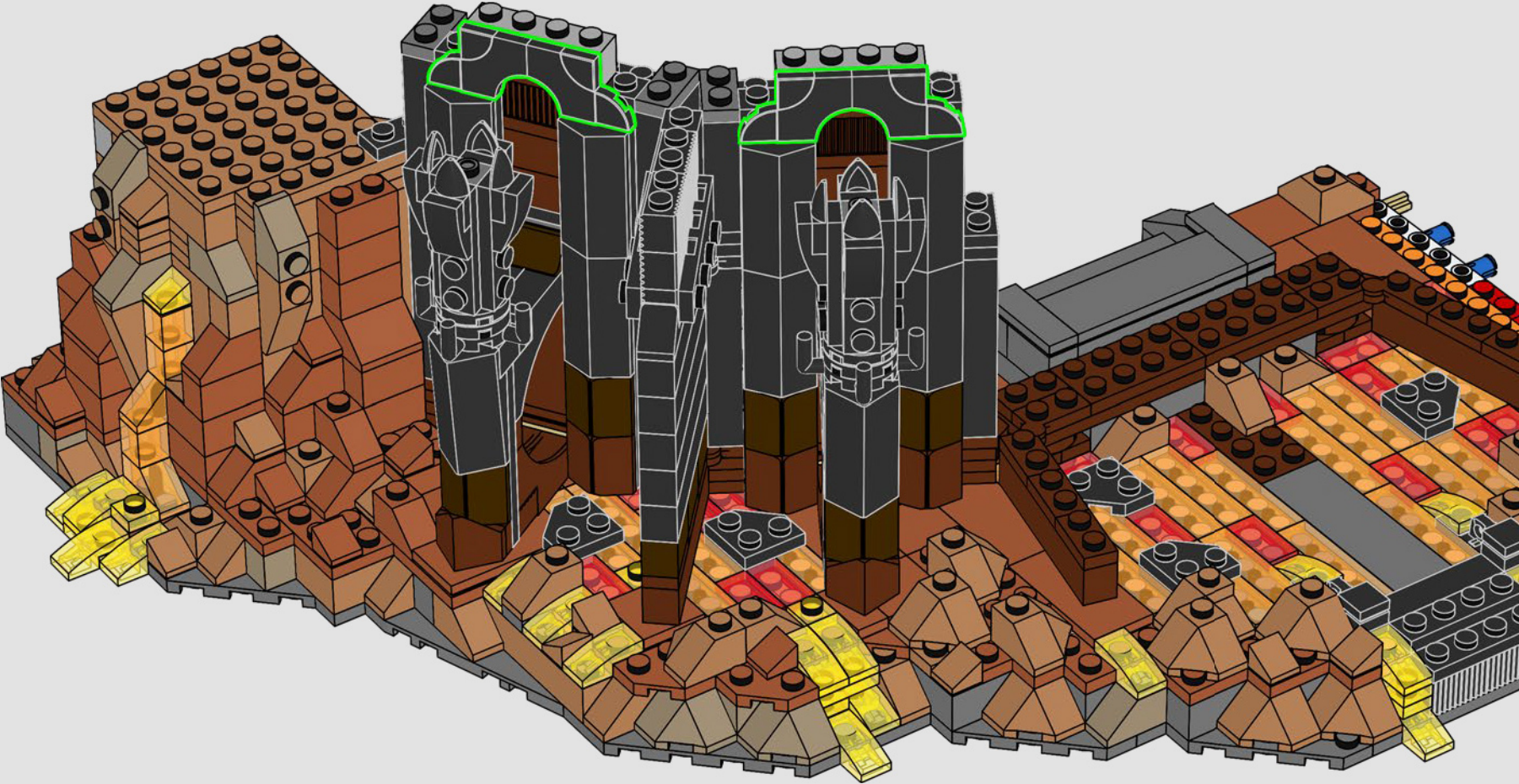

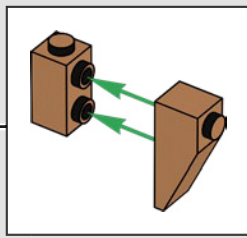
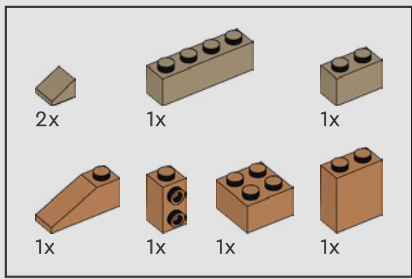

129

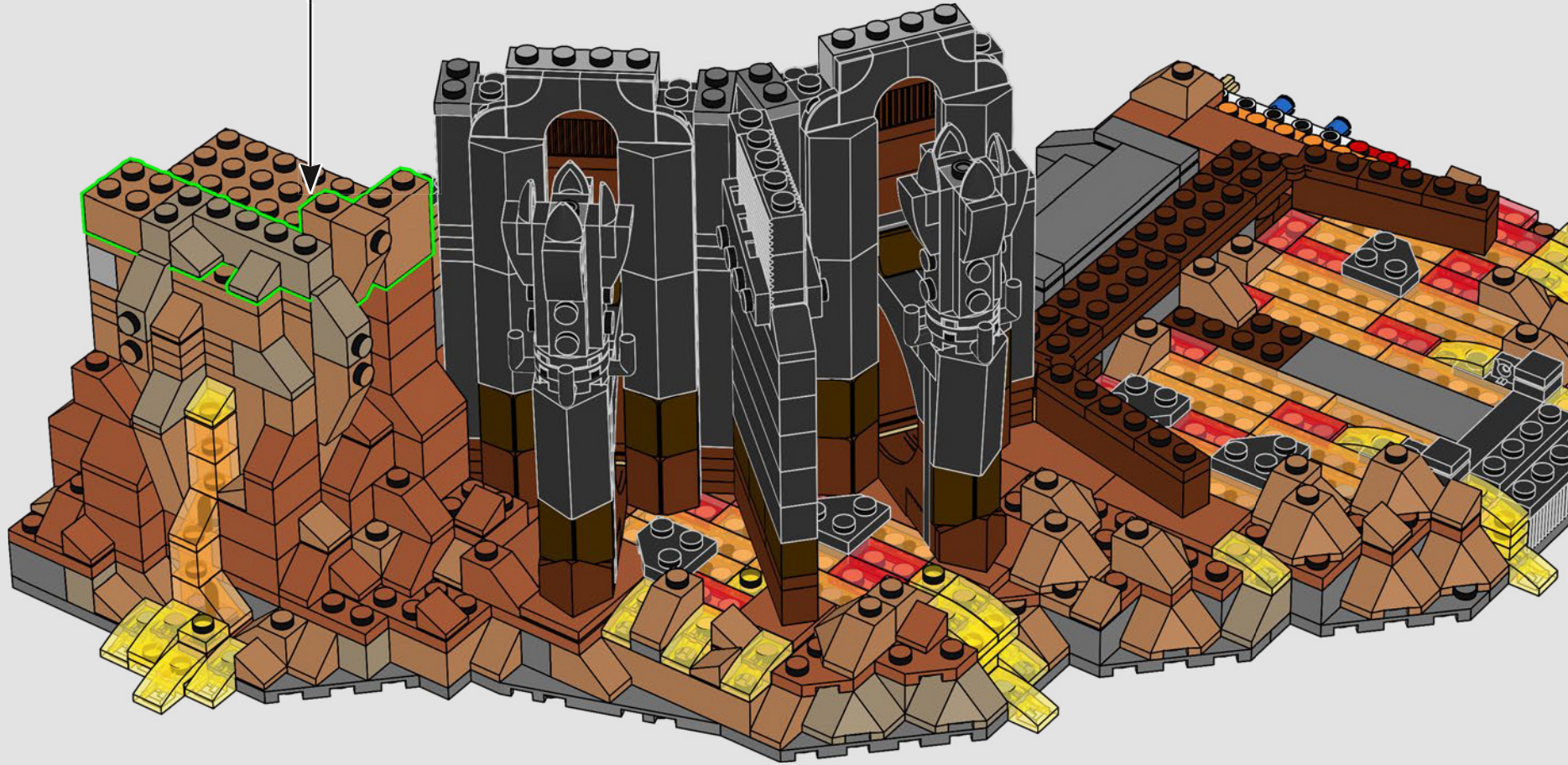

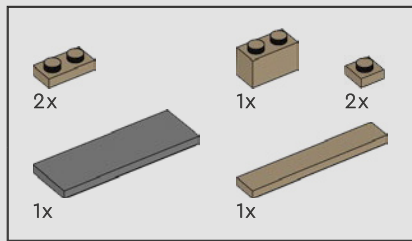

130

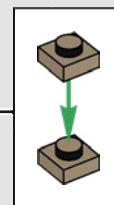
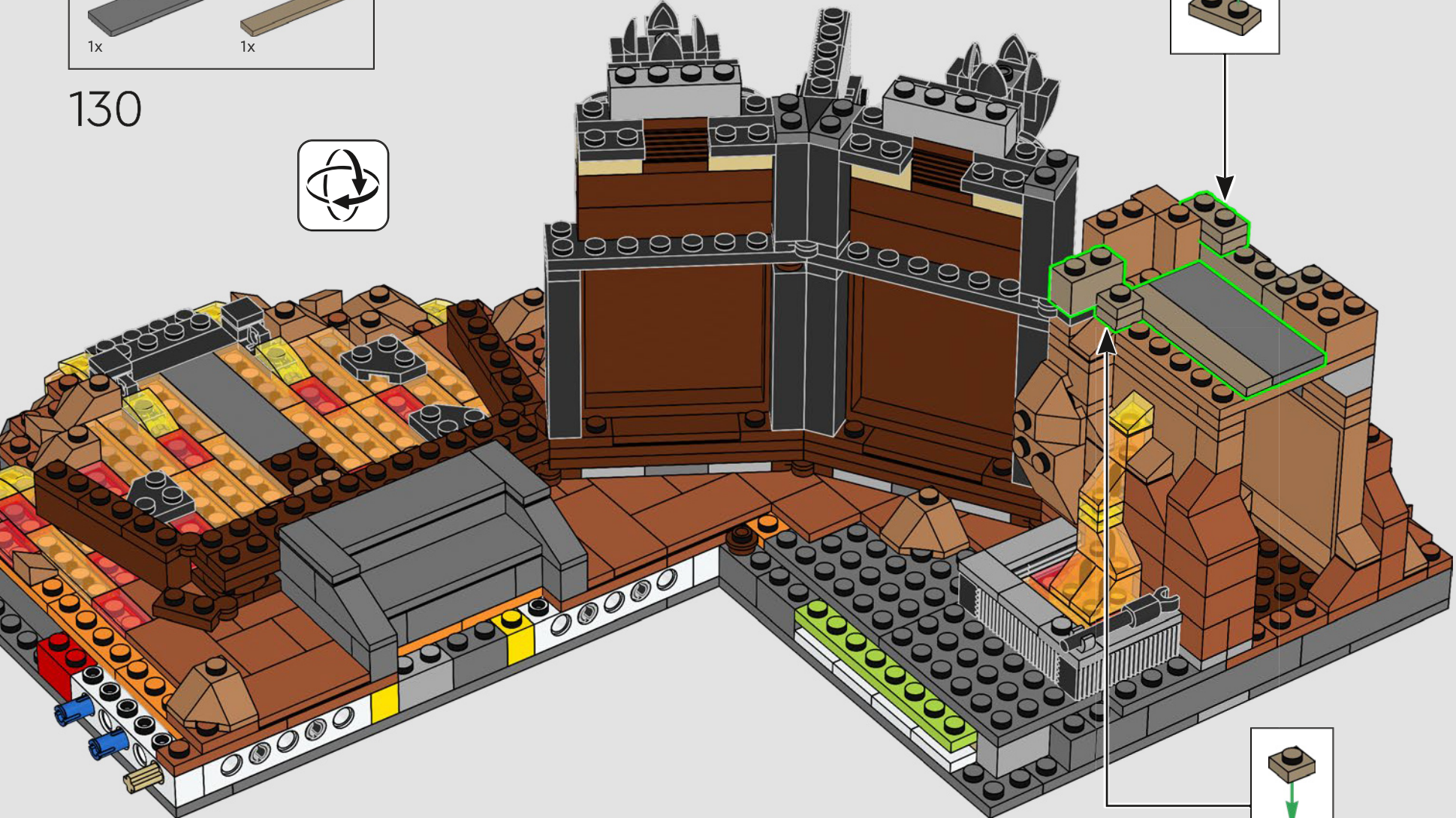
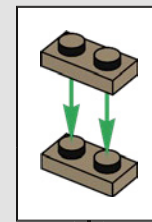

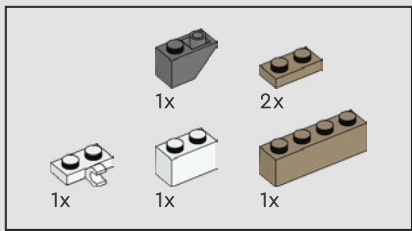

131

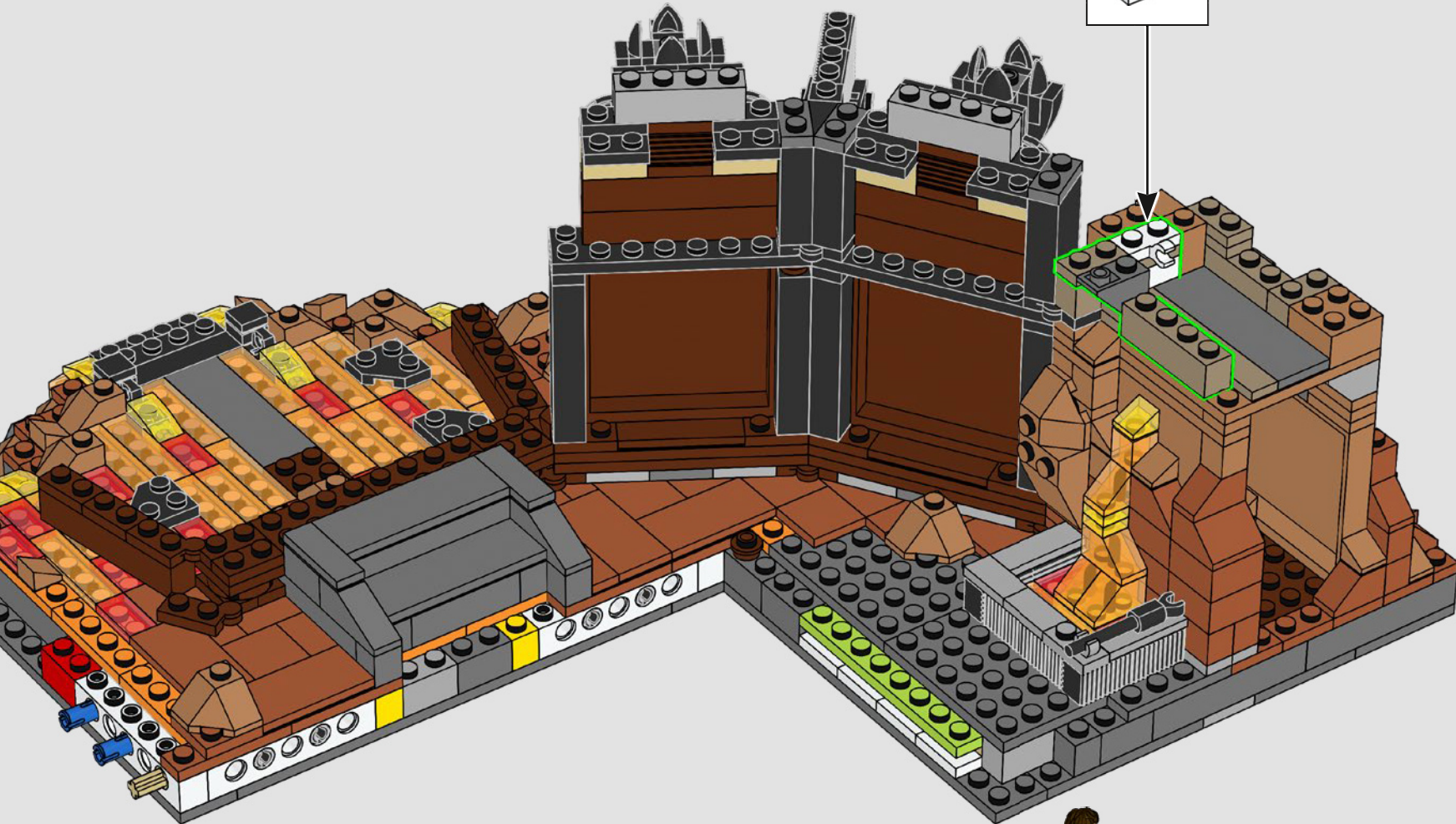
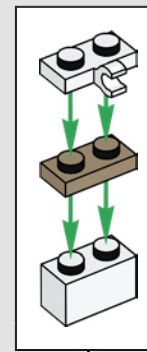

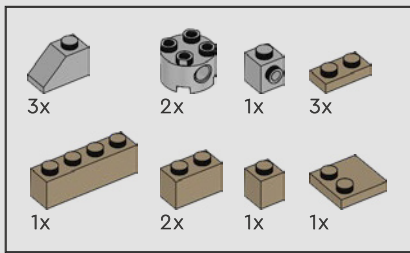

132

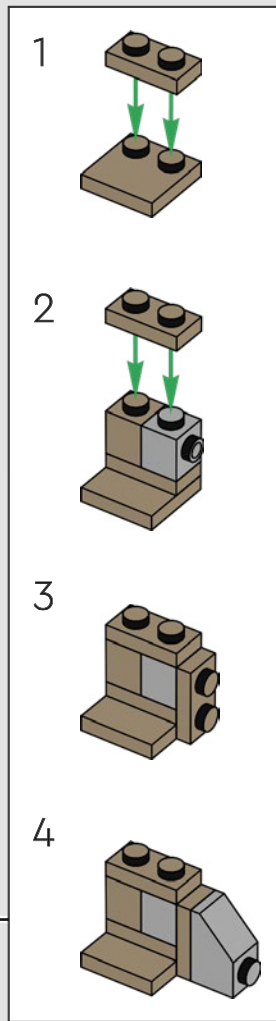
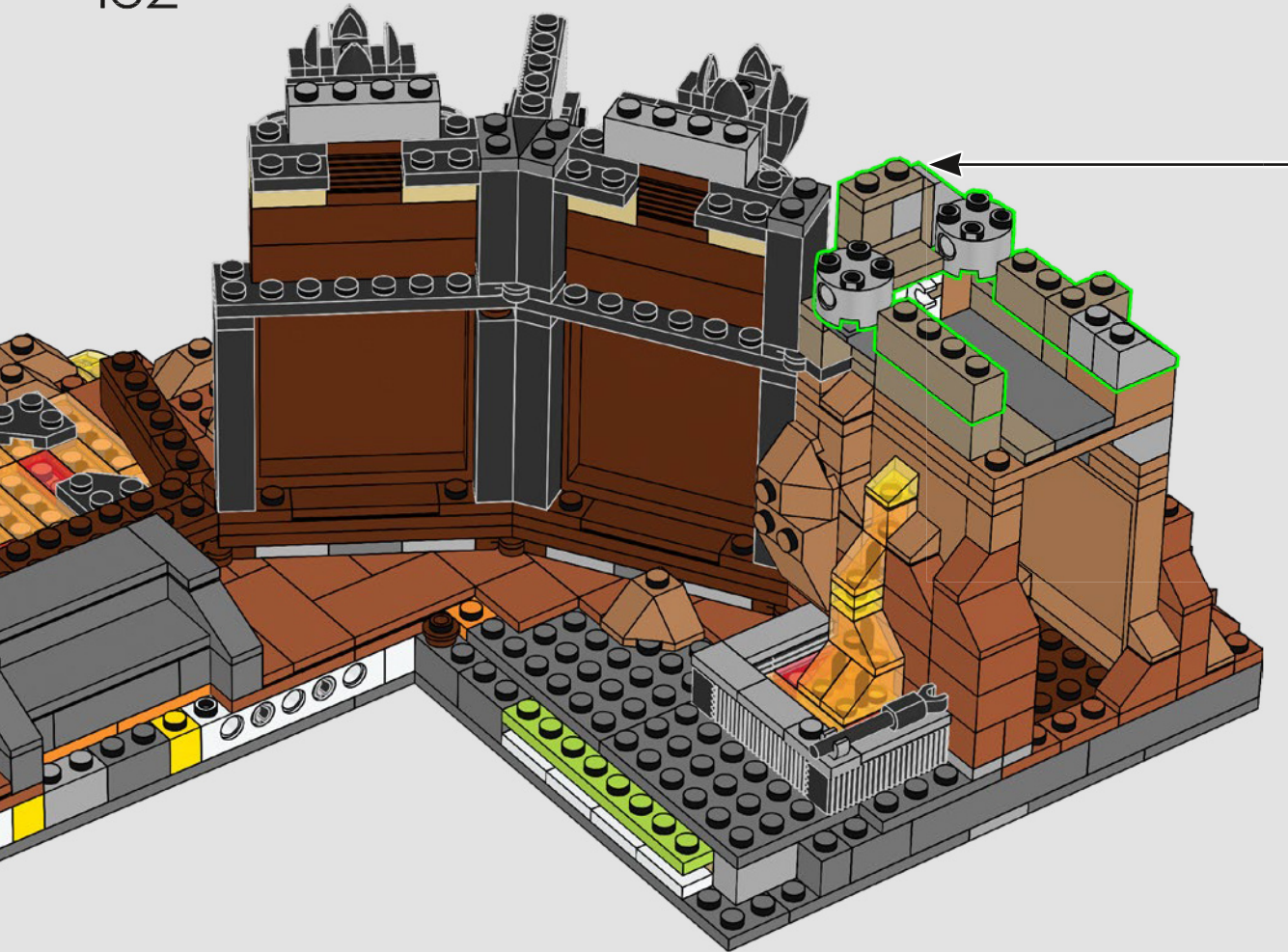

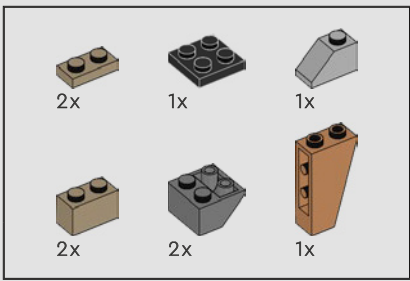

133

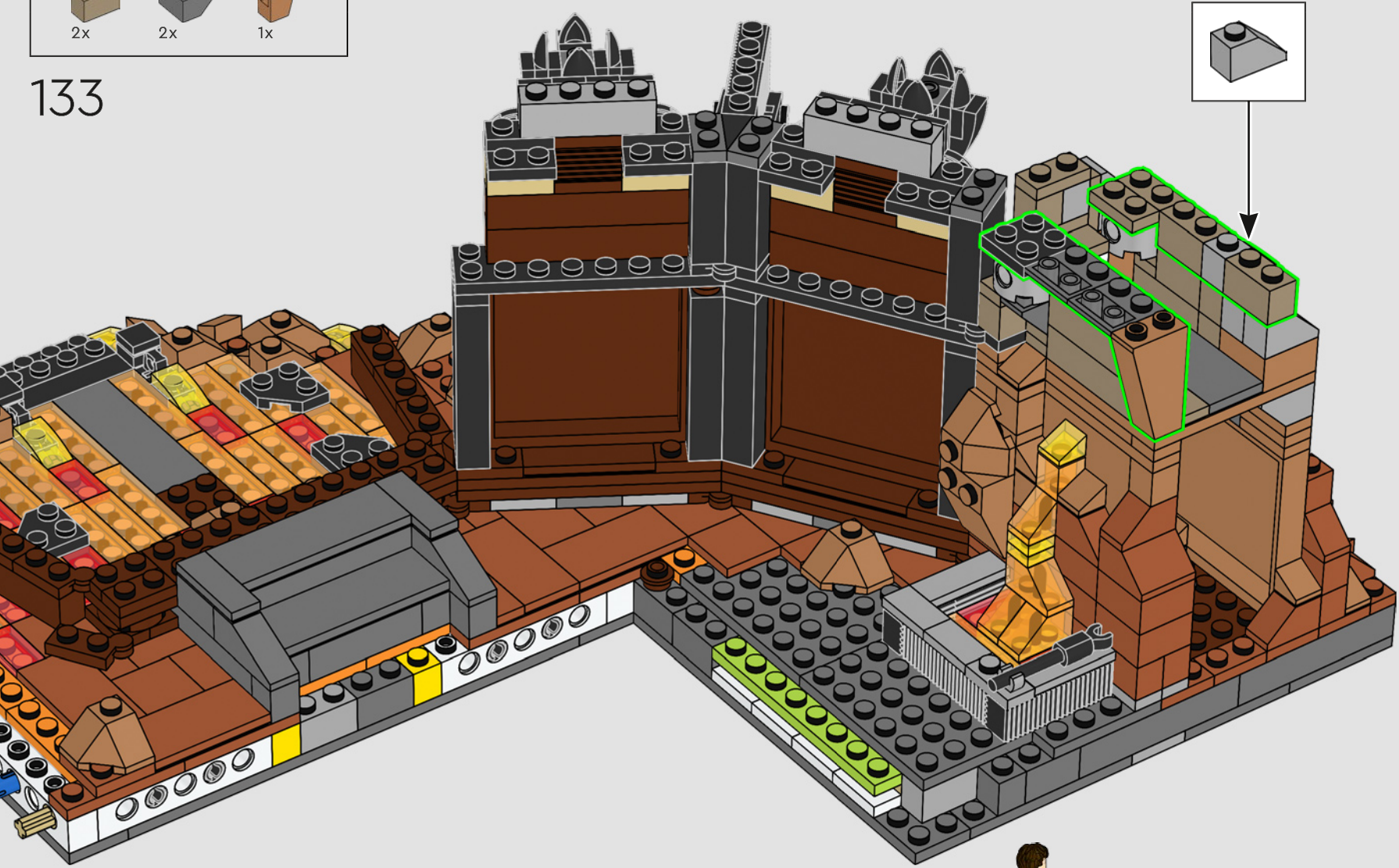

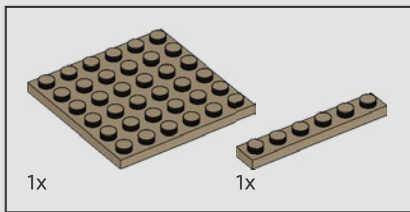

134

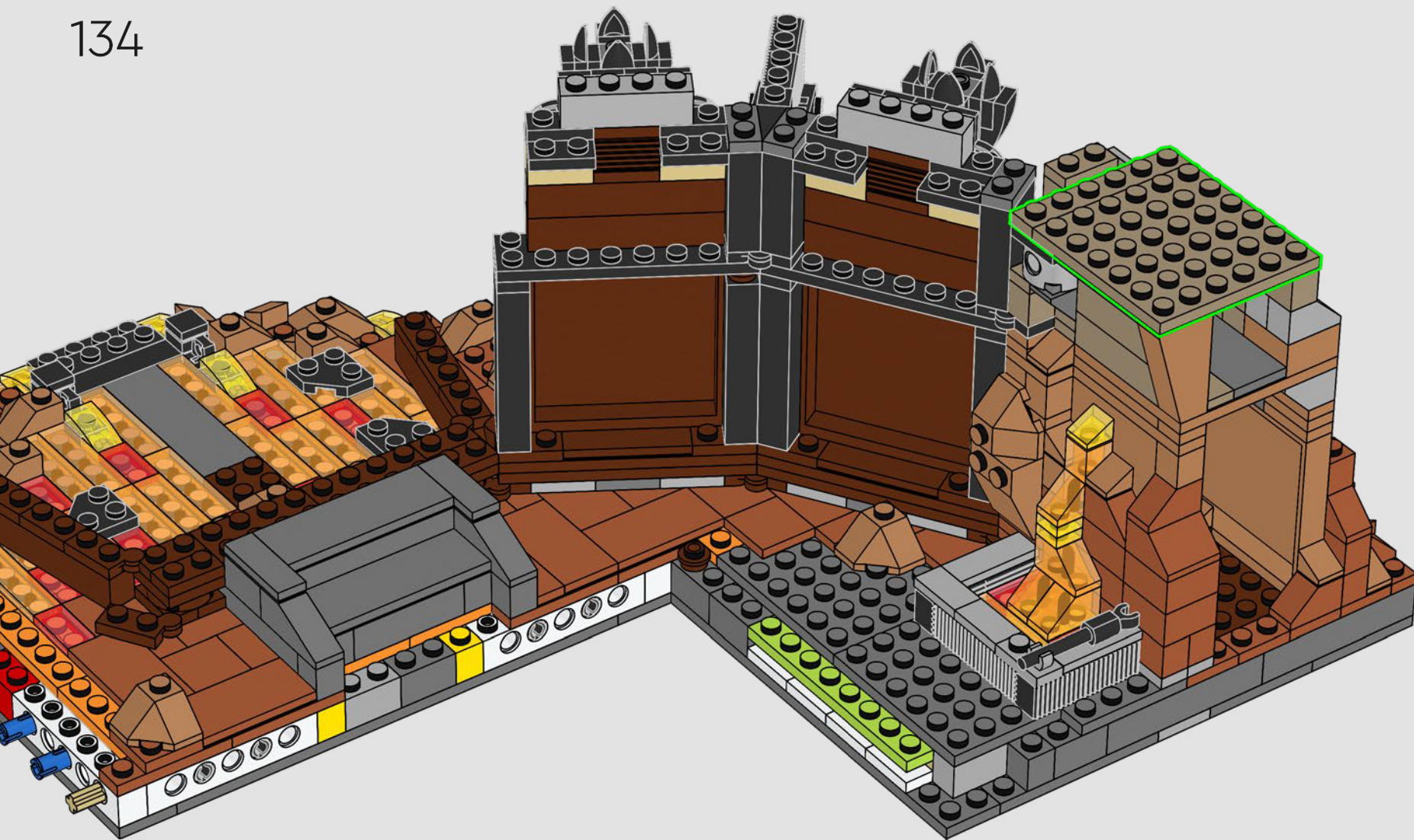

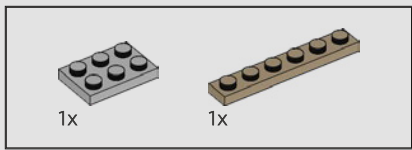

135

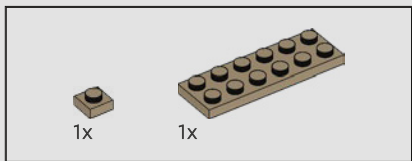
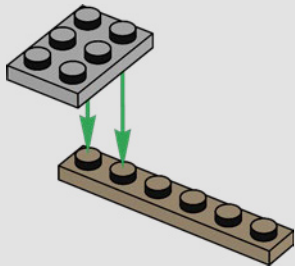

136

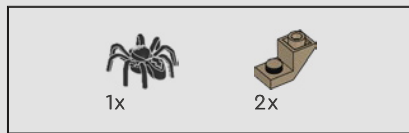
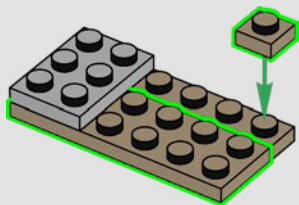

137

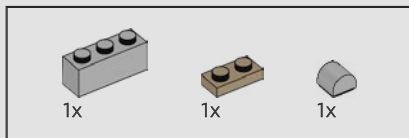
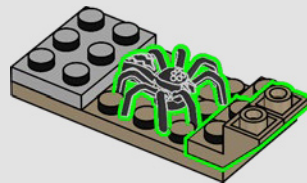

138

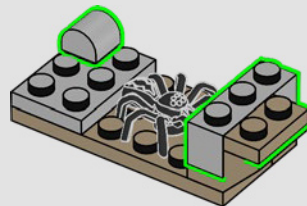

139

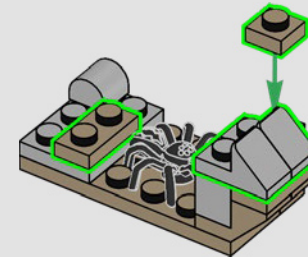

140

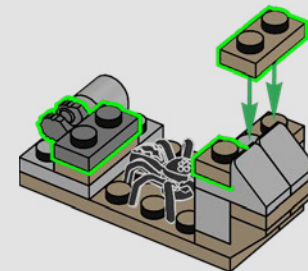

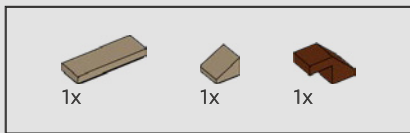

141

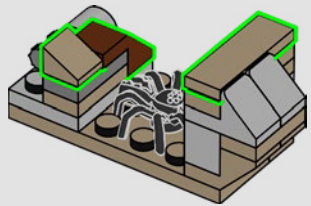

142

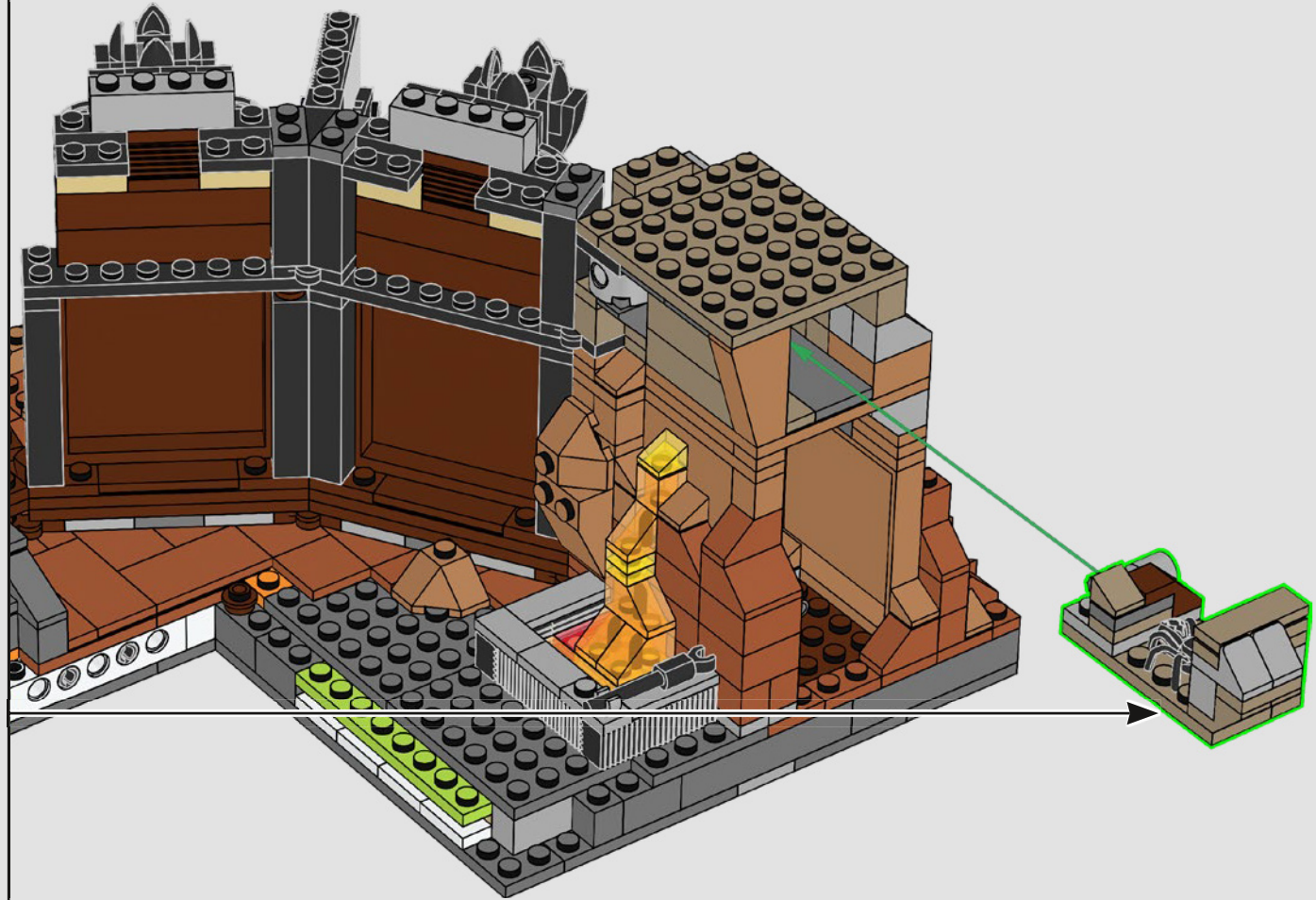

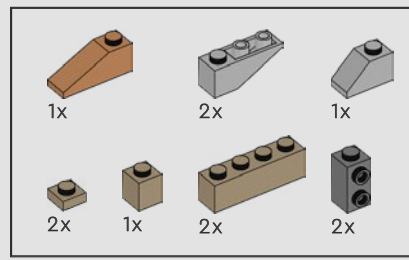

143

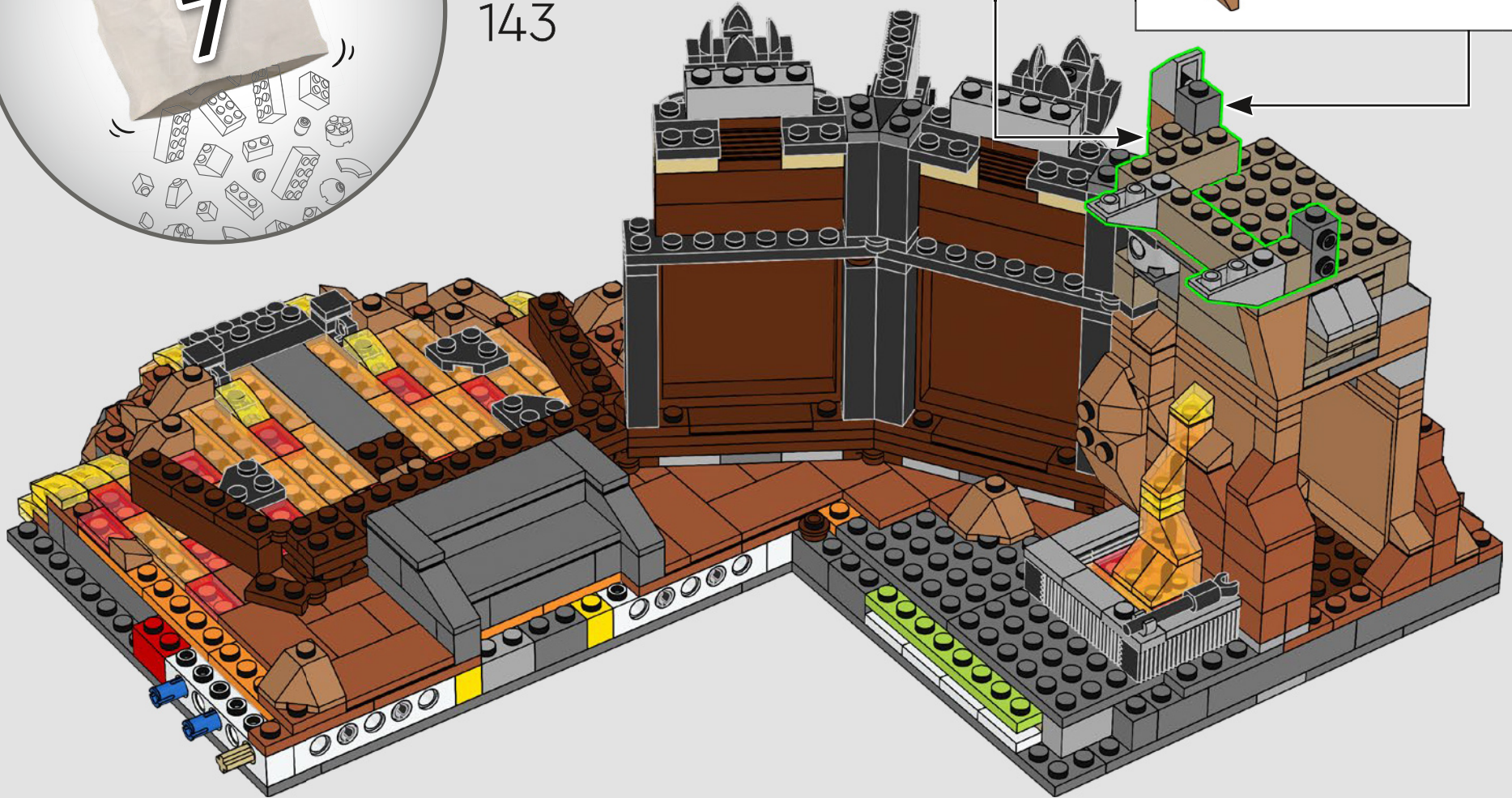
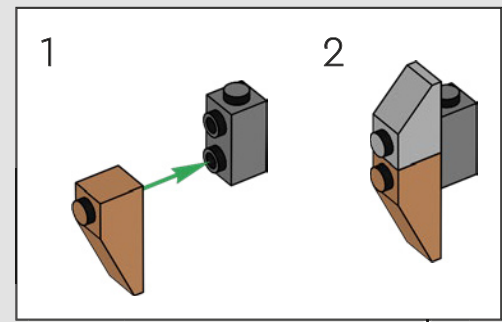
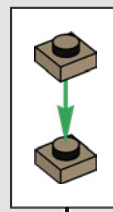

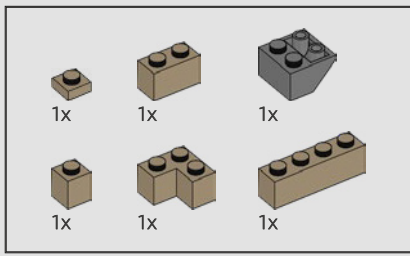

144



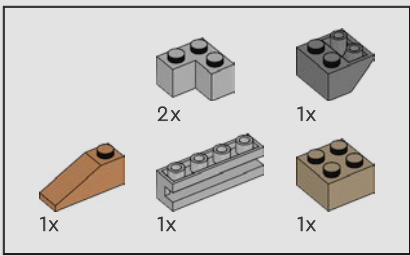

145

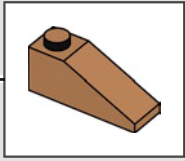
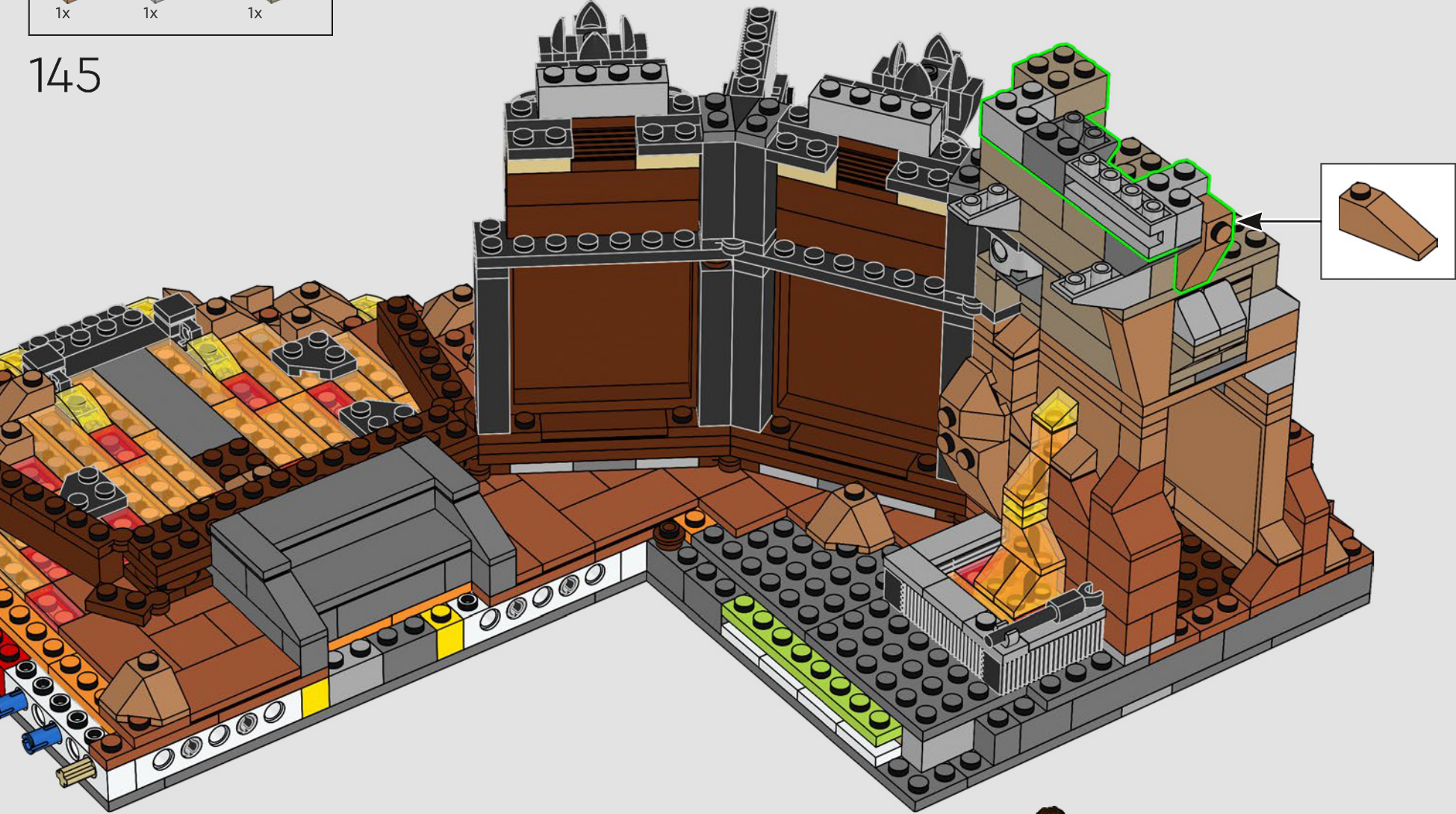

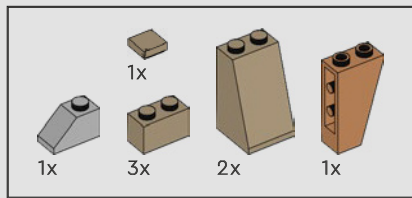

146

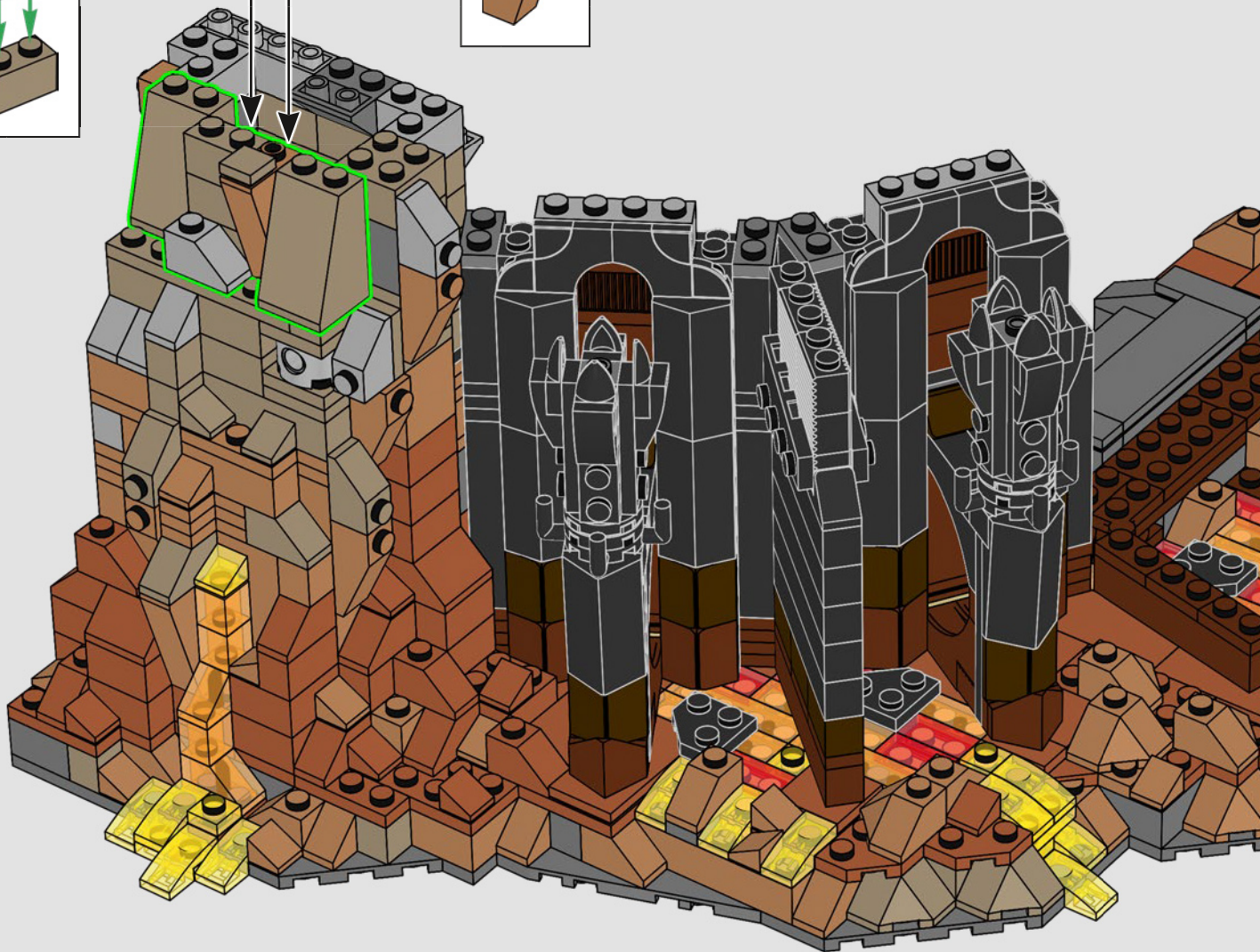
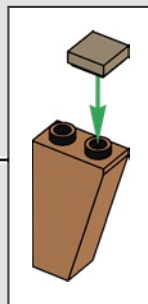
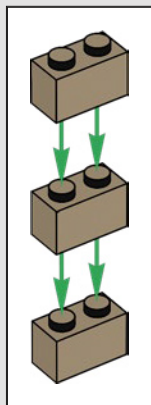

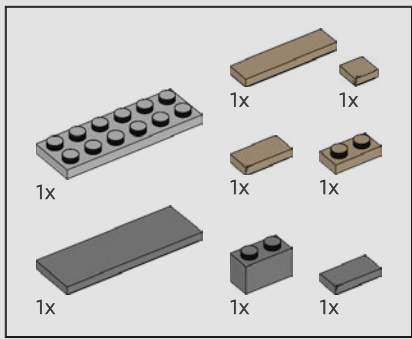

147

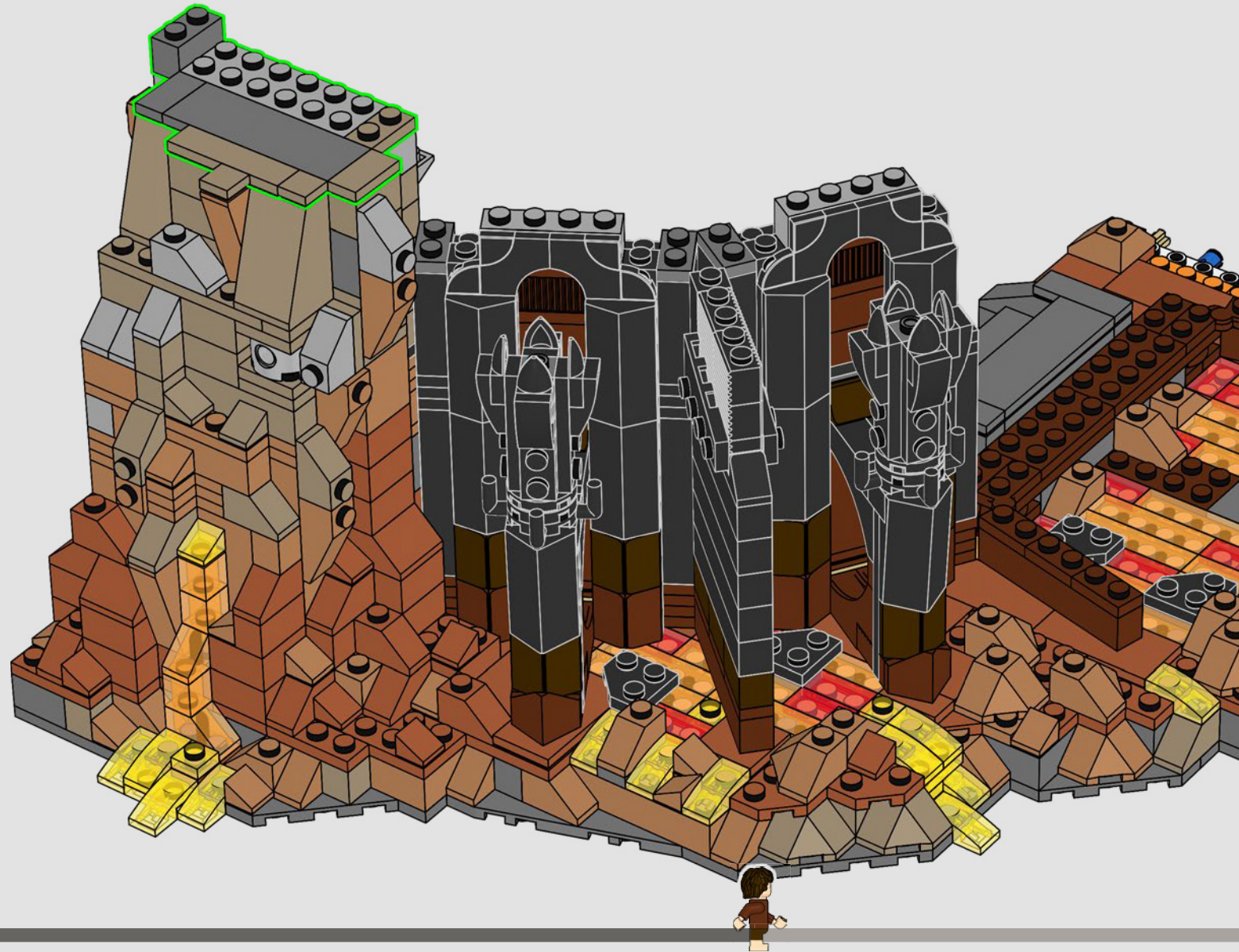

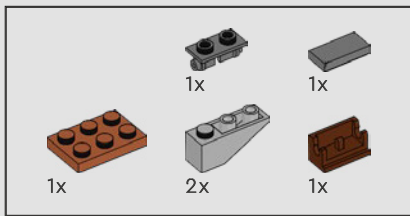

148

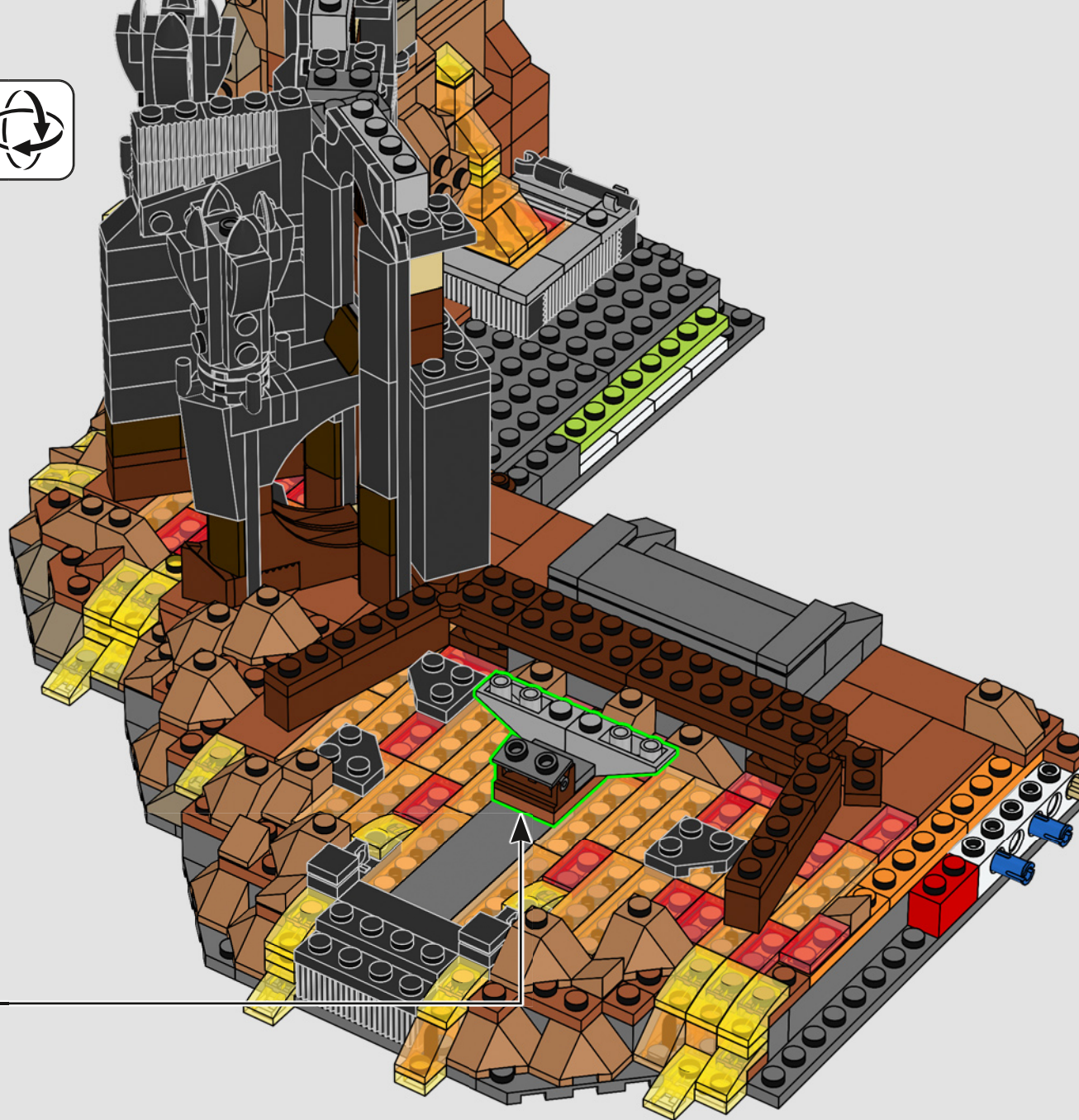
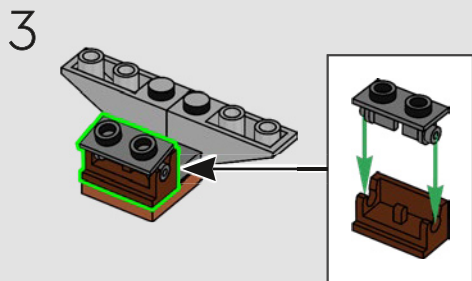
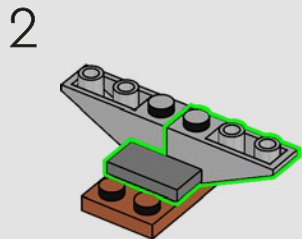
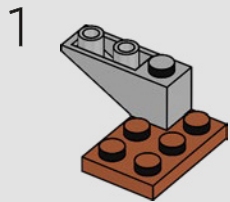

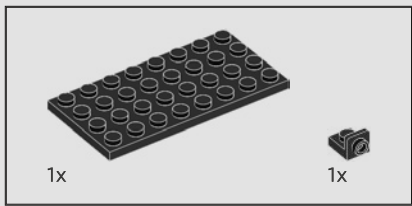

149

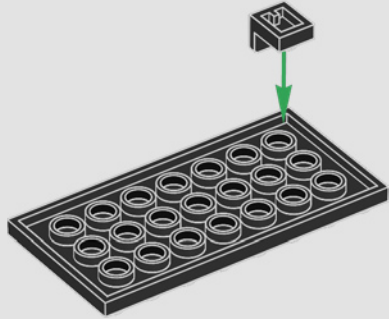

150

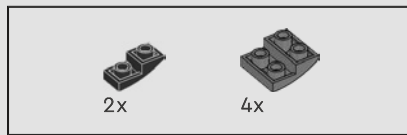
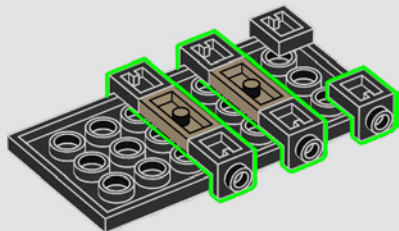

151

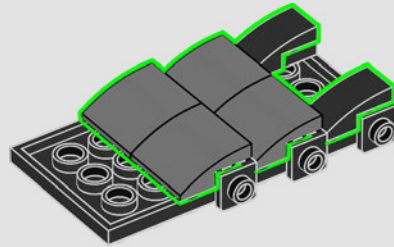

152

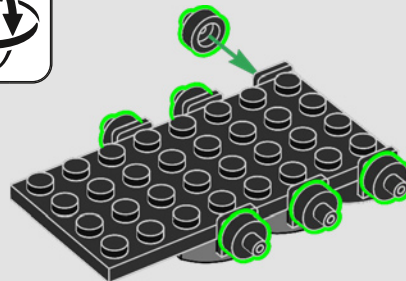

153

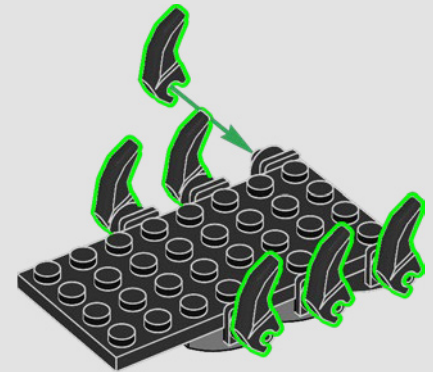

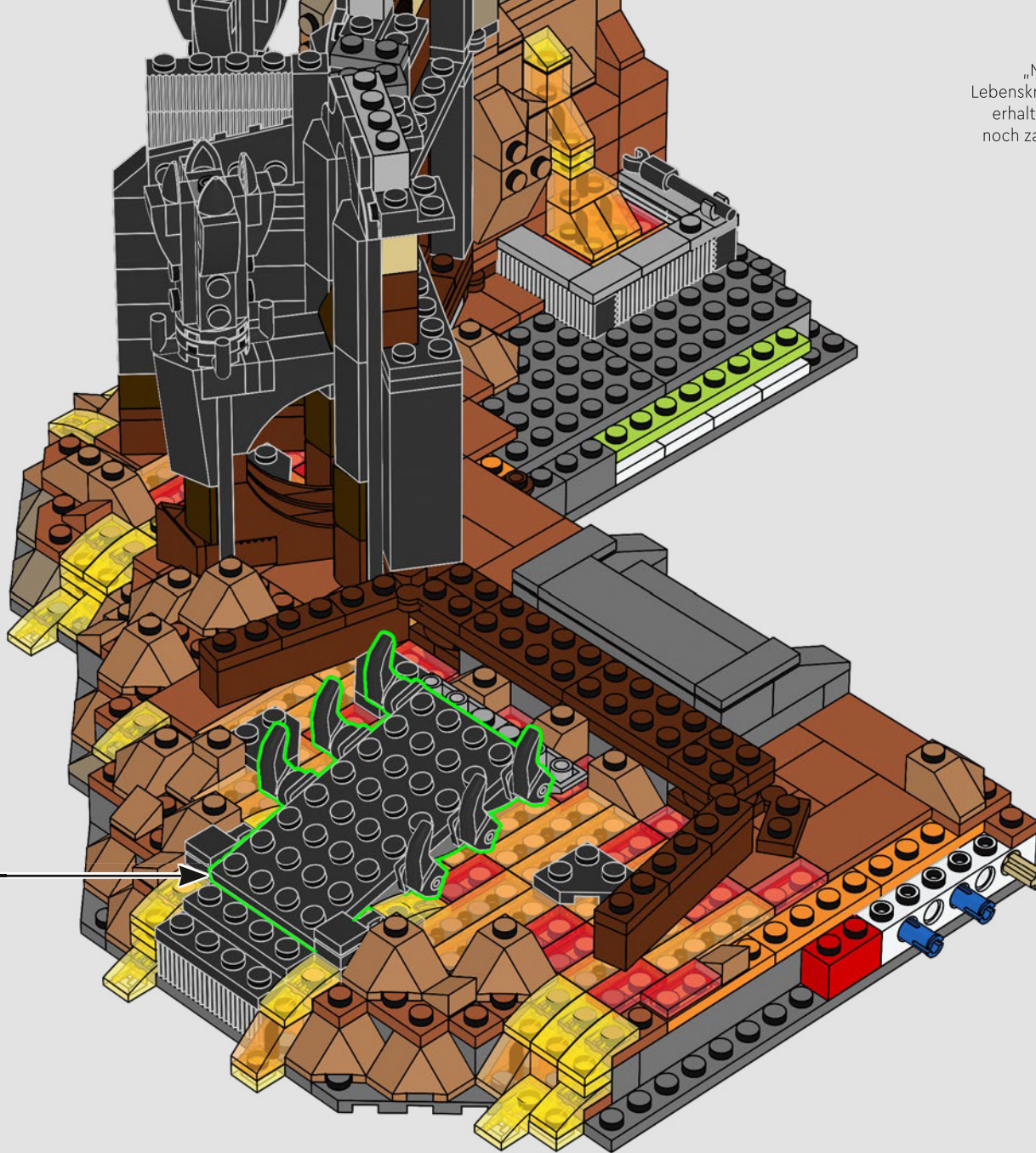

„Nein, Frodo. Der Geist Saurons lebte weiter. Seine Lebenskraft ist an den Ring gebunden, und der Ring blieb erhalten. Sauron ist zurückgekehrt, und seine Orks sind noch zahlreicher geworden. Seine Festung Barad-dûr ist wiedererrichtet worden in Mordor.“ – Gandalf

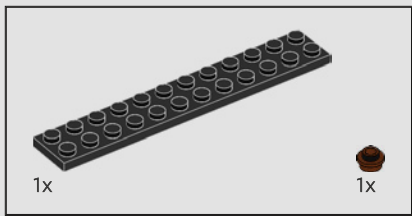

155

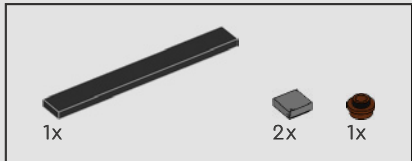
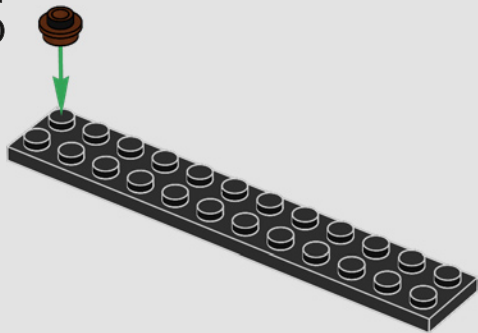

156

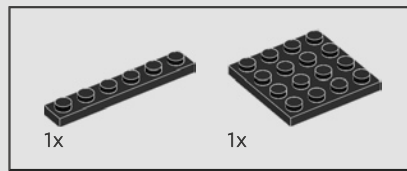
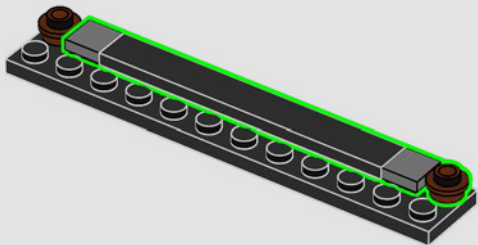

157

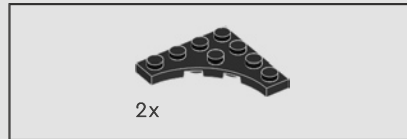
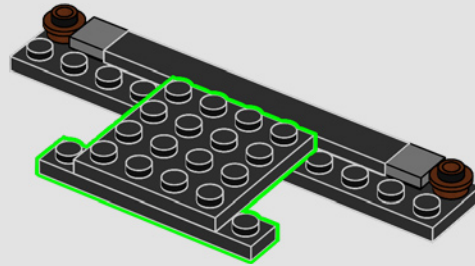

158

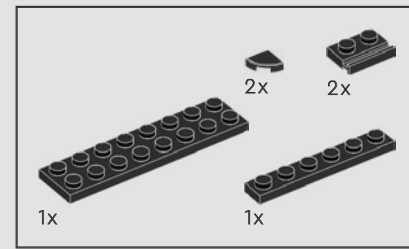
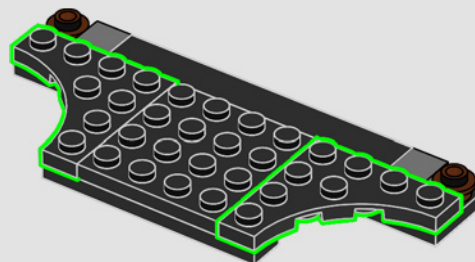

159

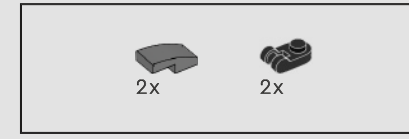
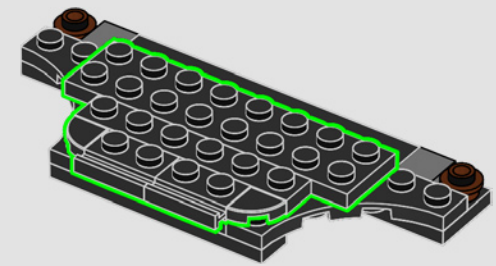

160

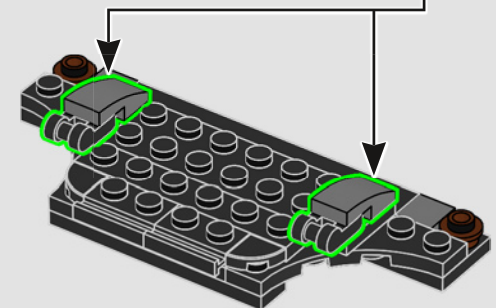
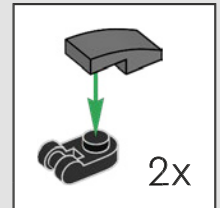



161

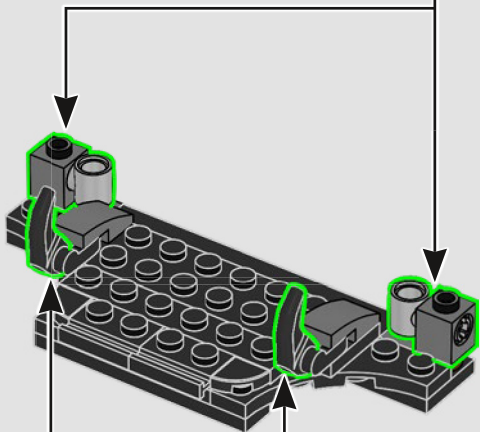
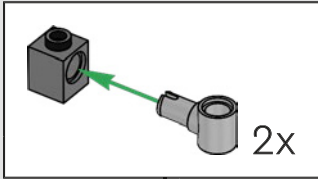

162

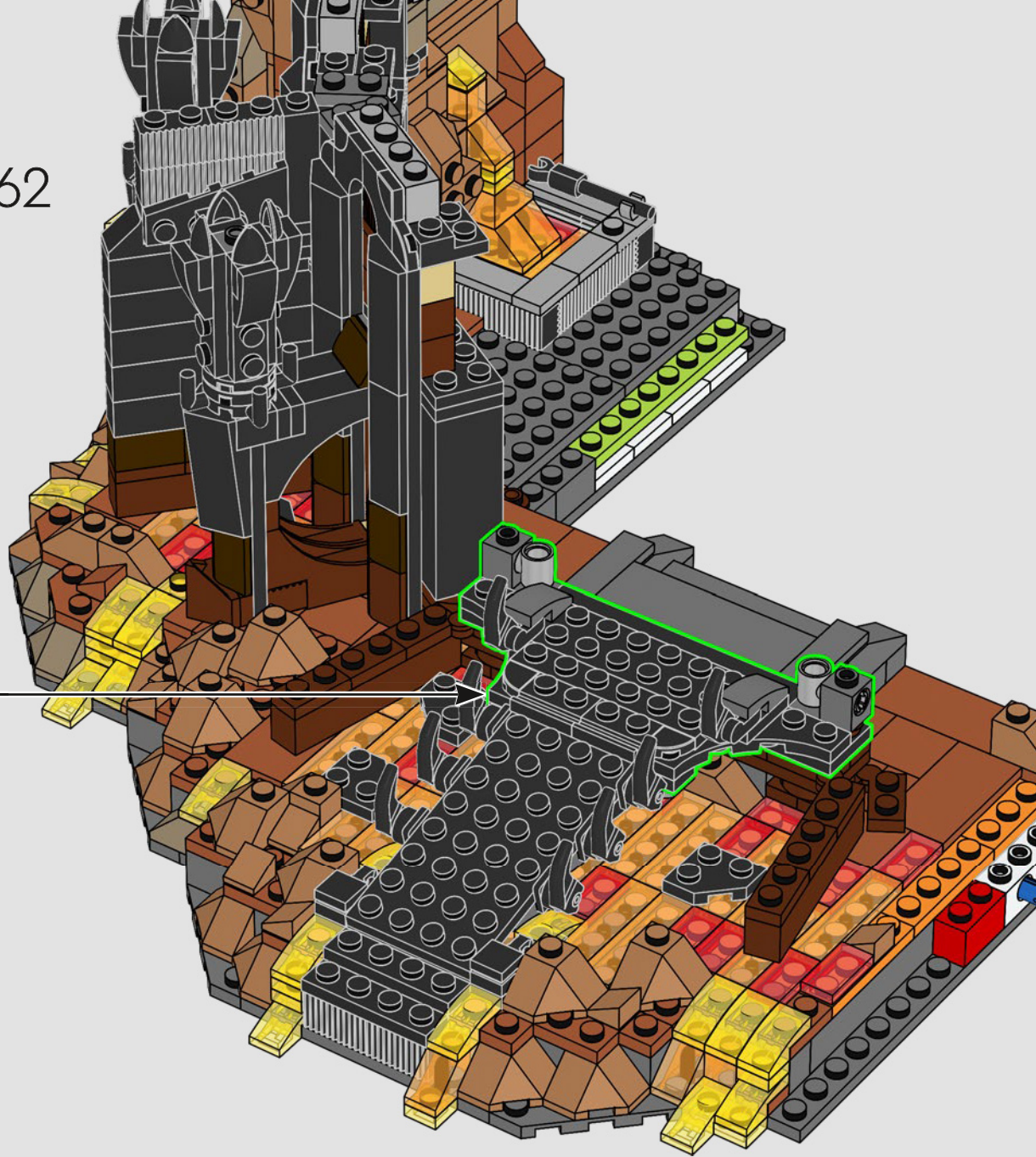

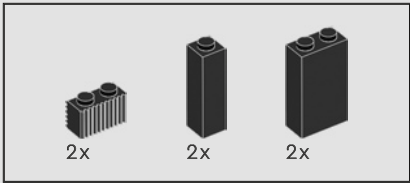

163

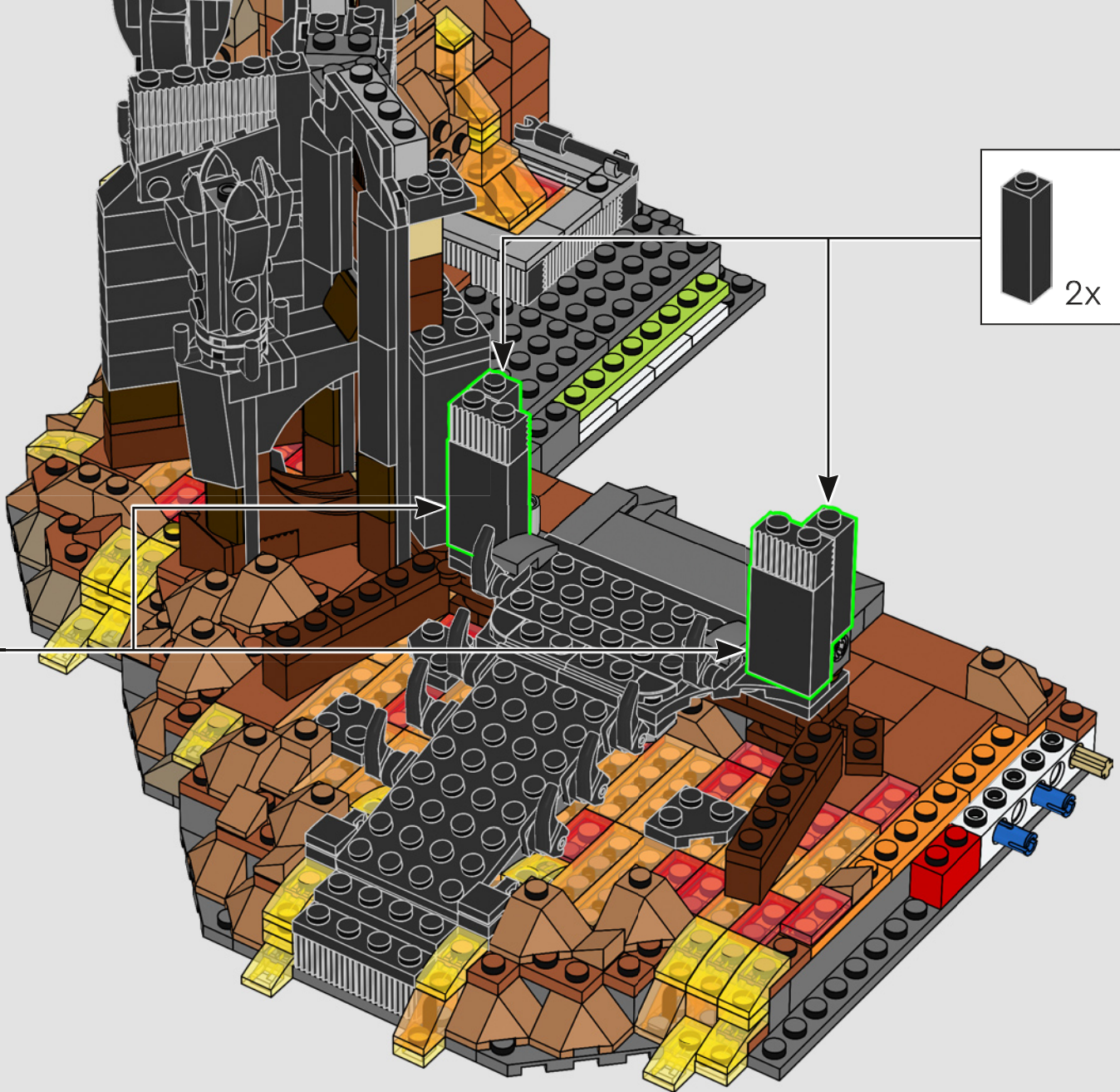
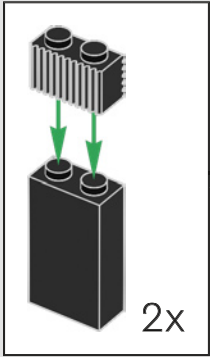
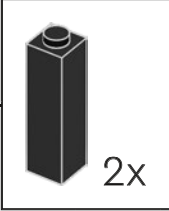

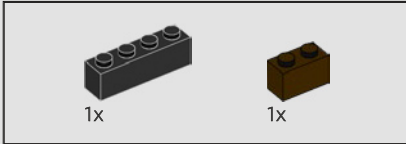
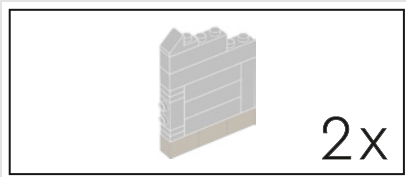

164

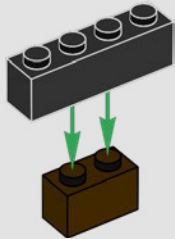

165

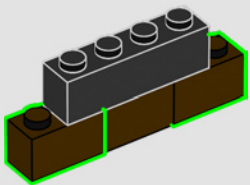

166

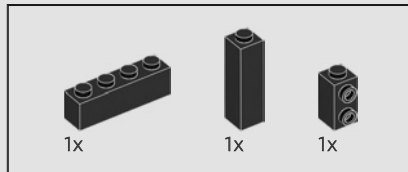
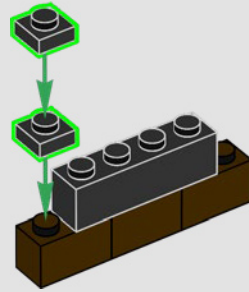

167

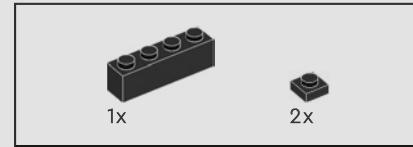
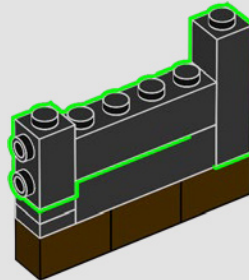

168

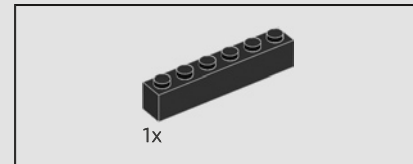
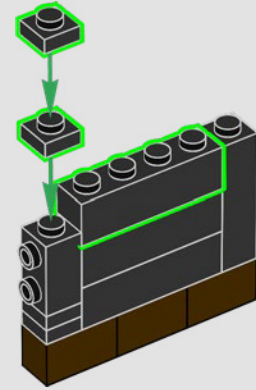

169

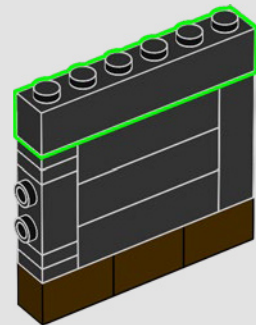

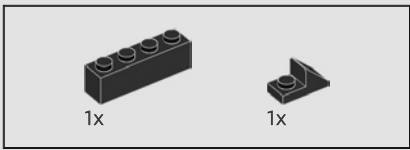

170

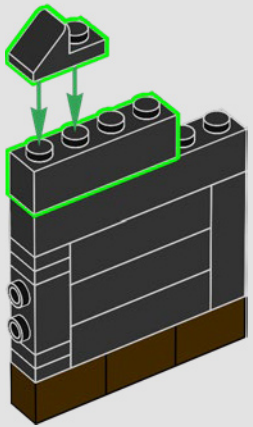

2x

171

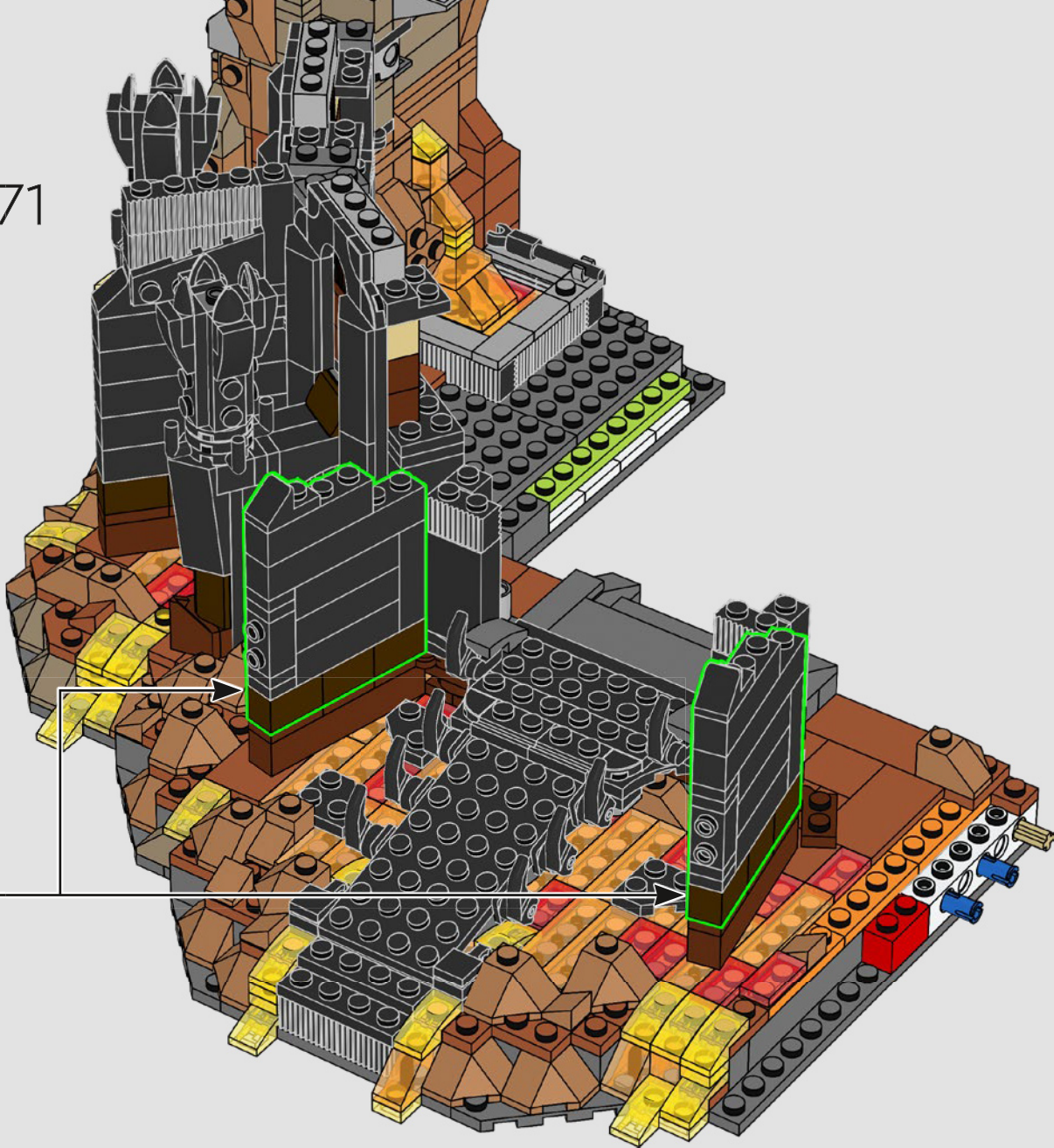

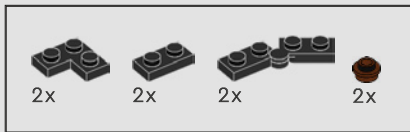

172

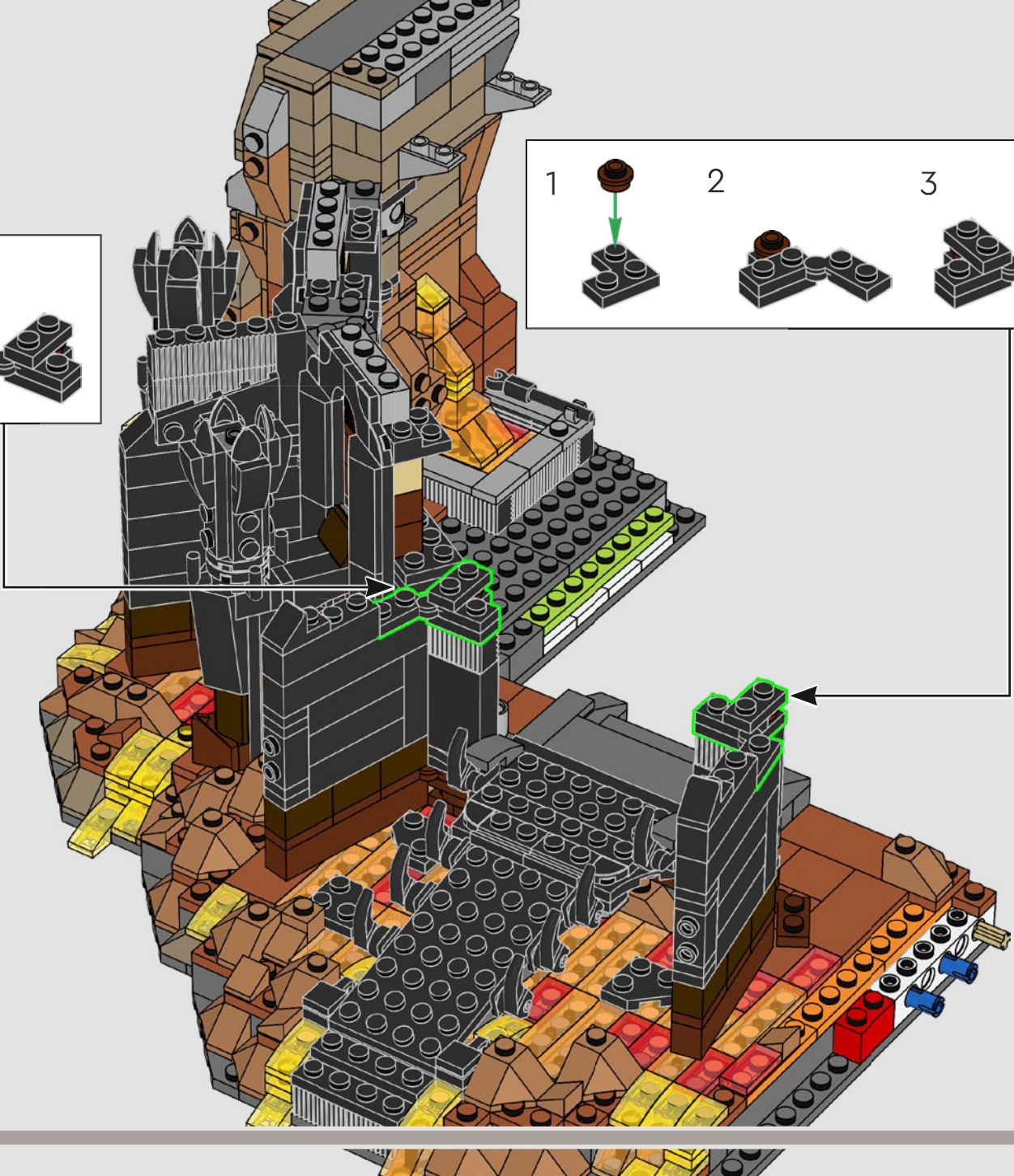
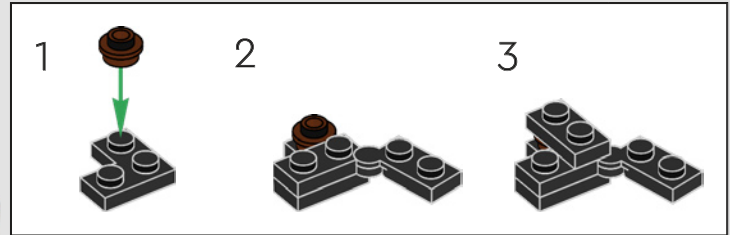
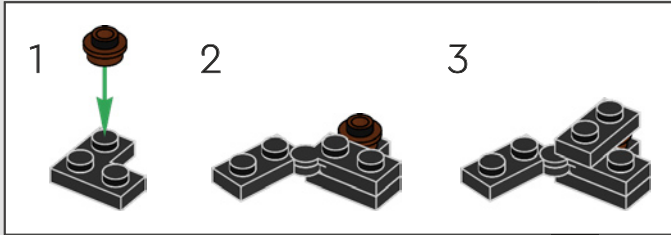

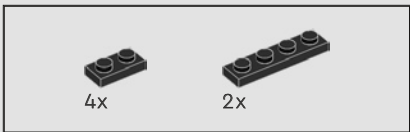

173

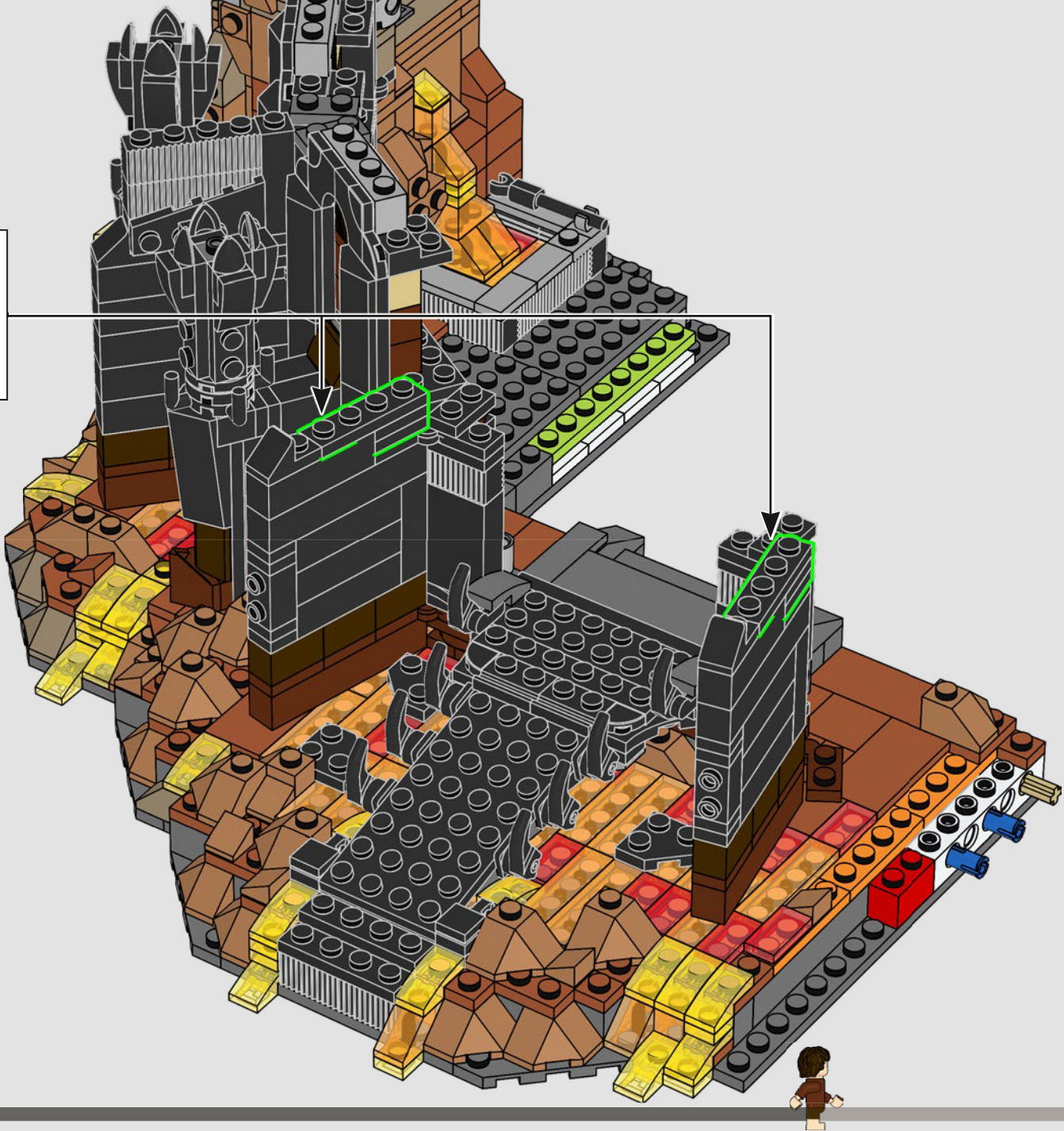
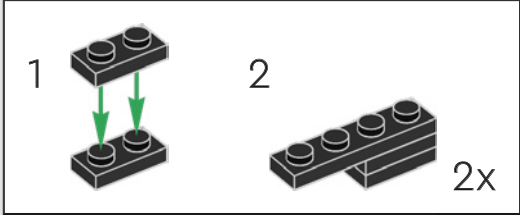

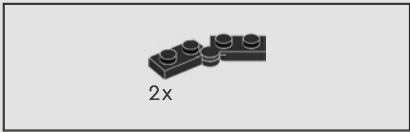

174

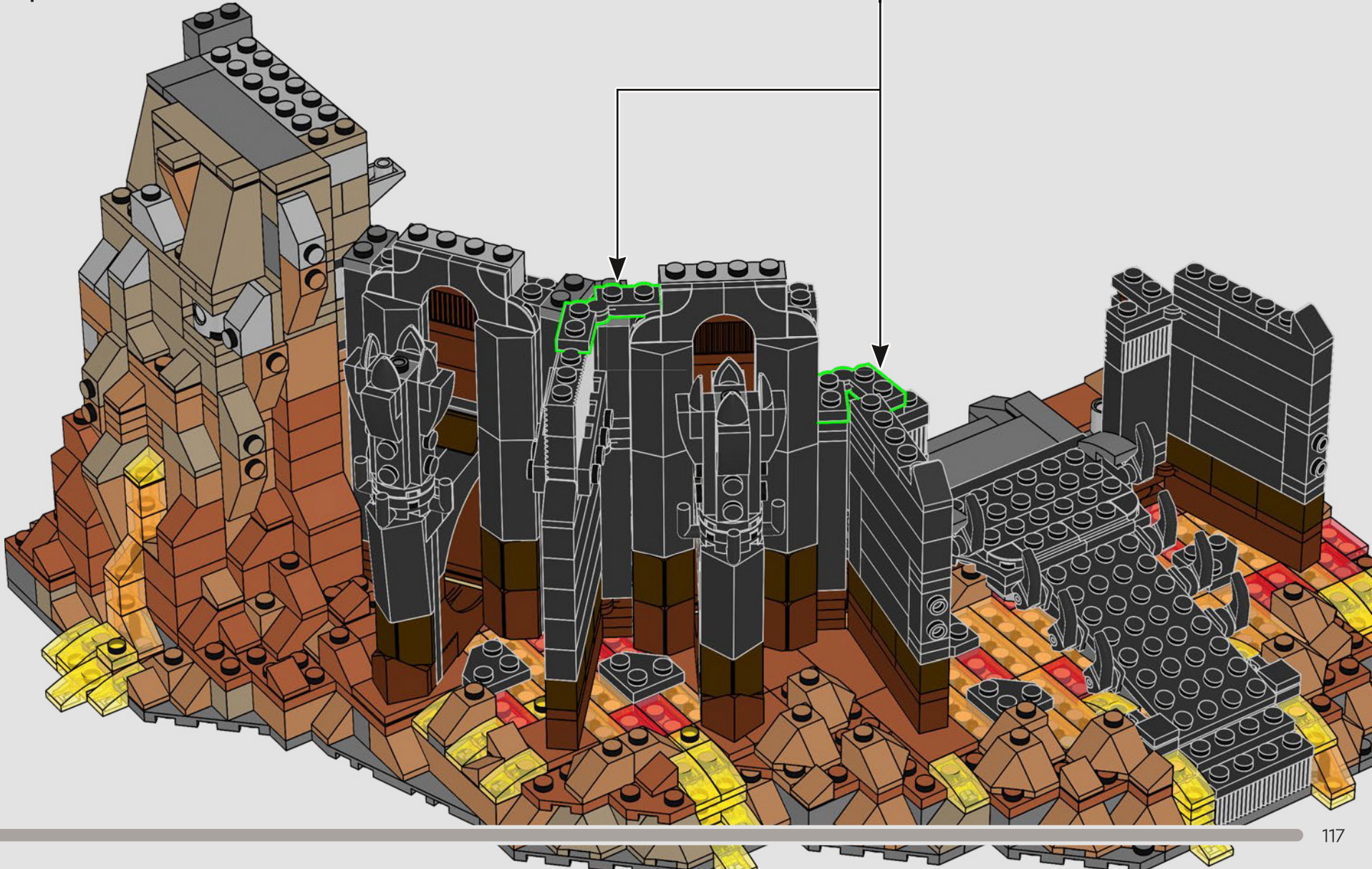
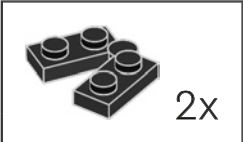

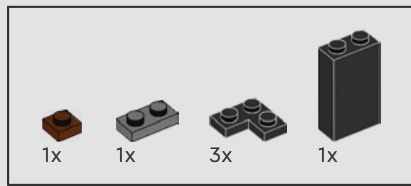

175

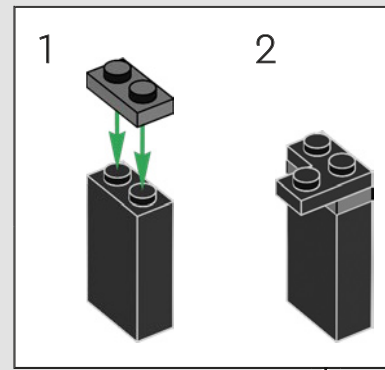

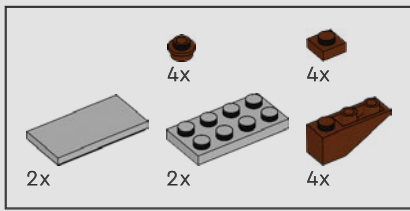

176

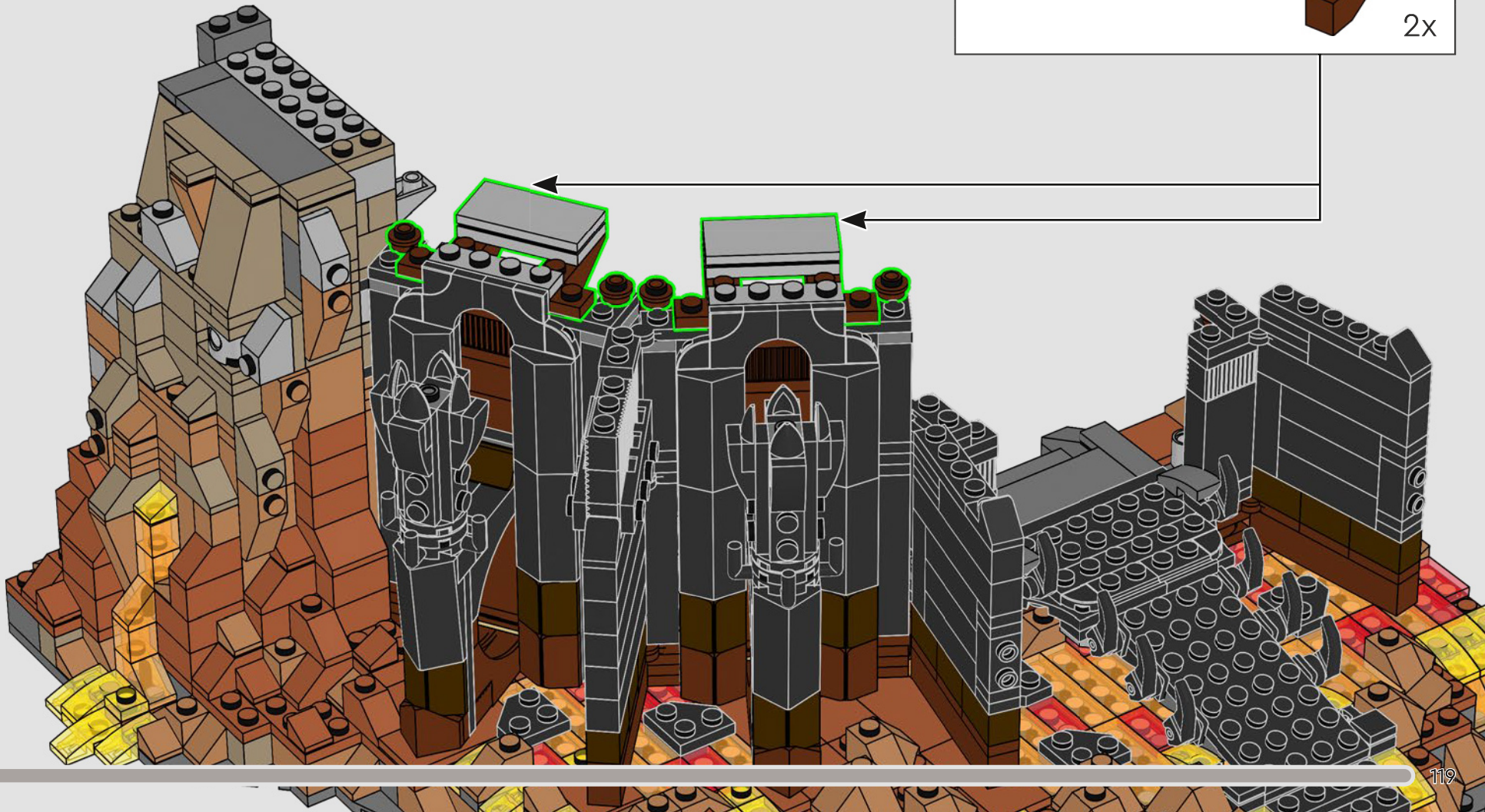
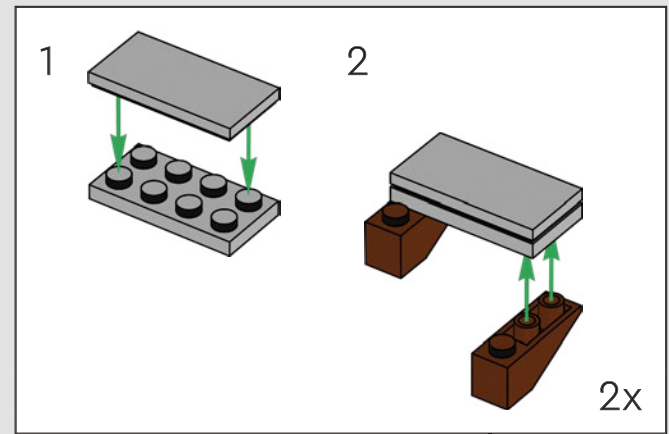

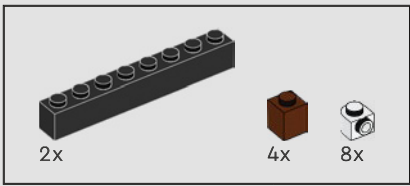

177

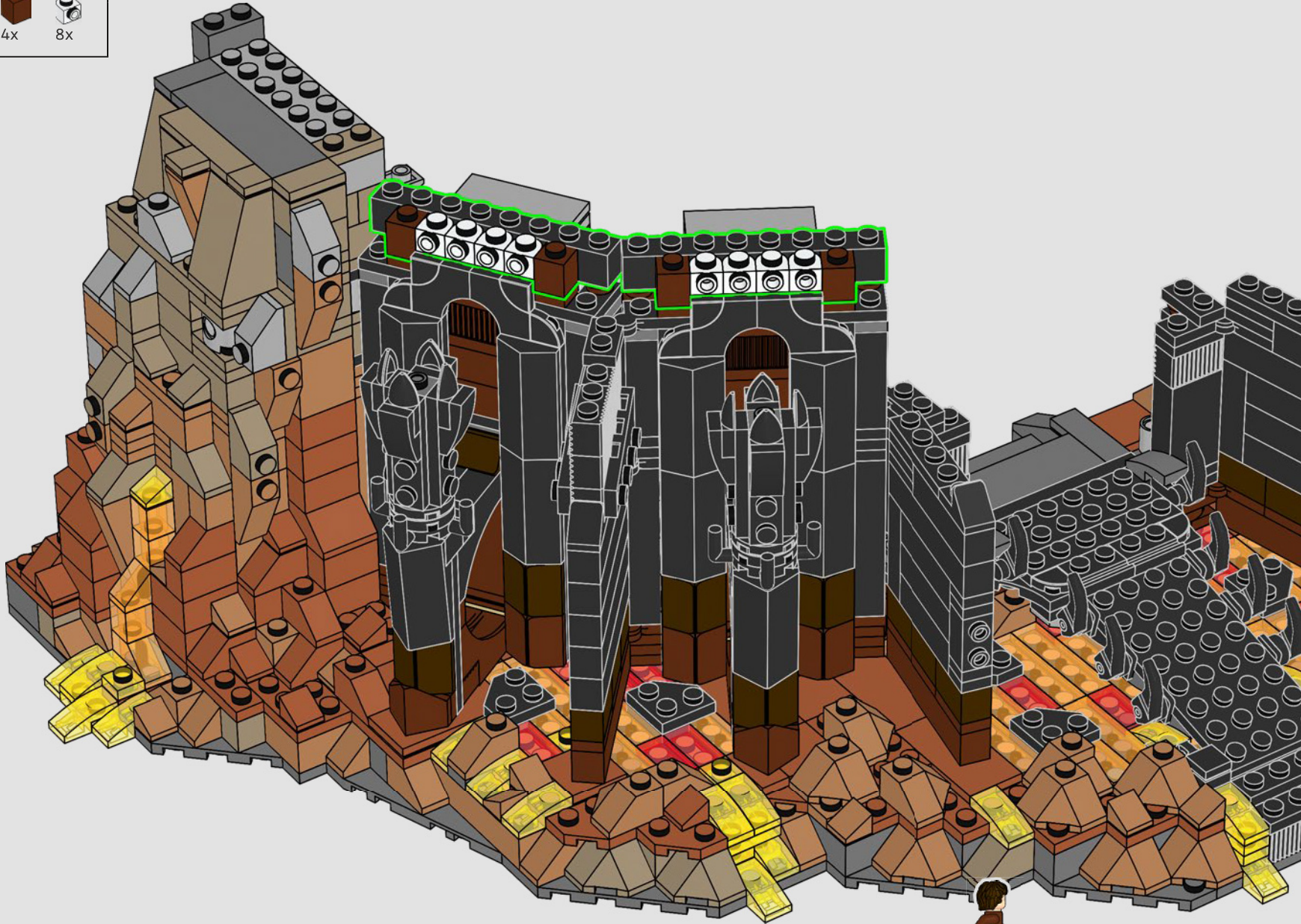

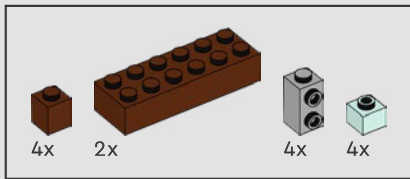

178

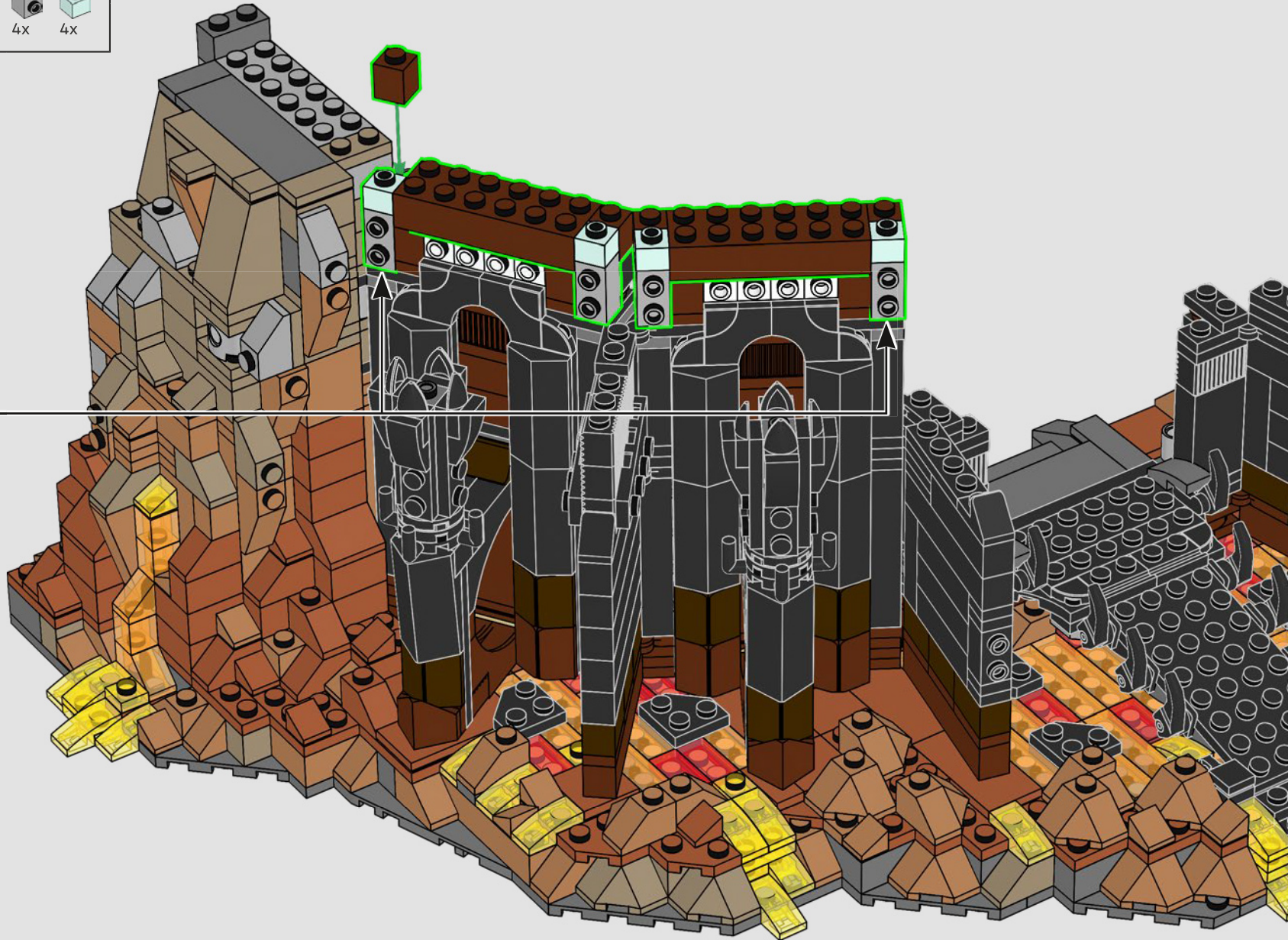
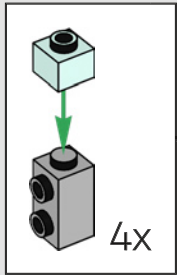

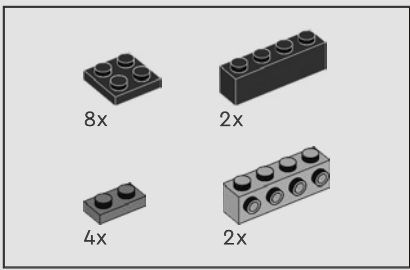

179

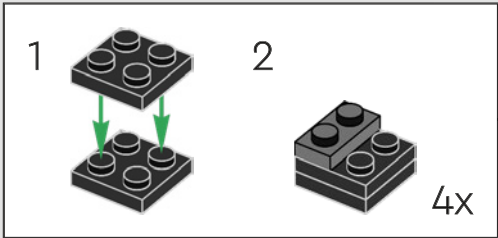

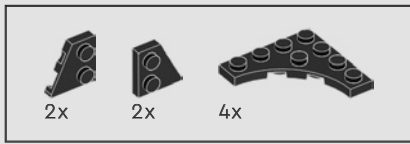

180

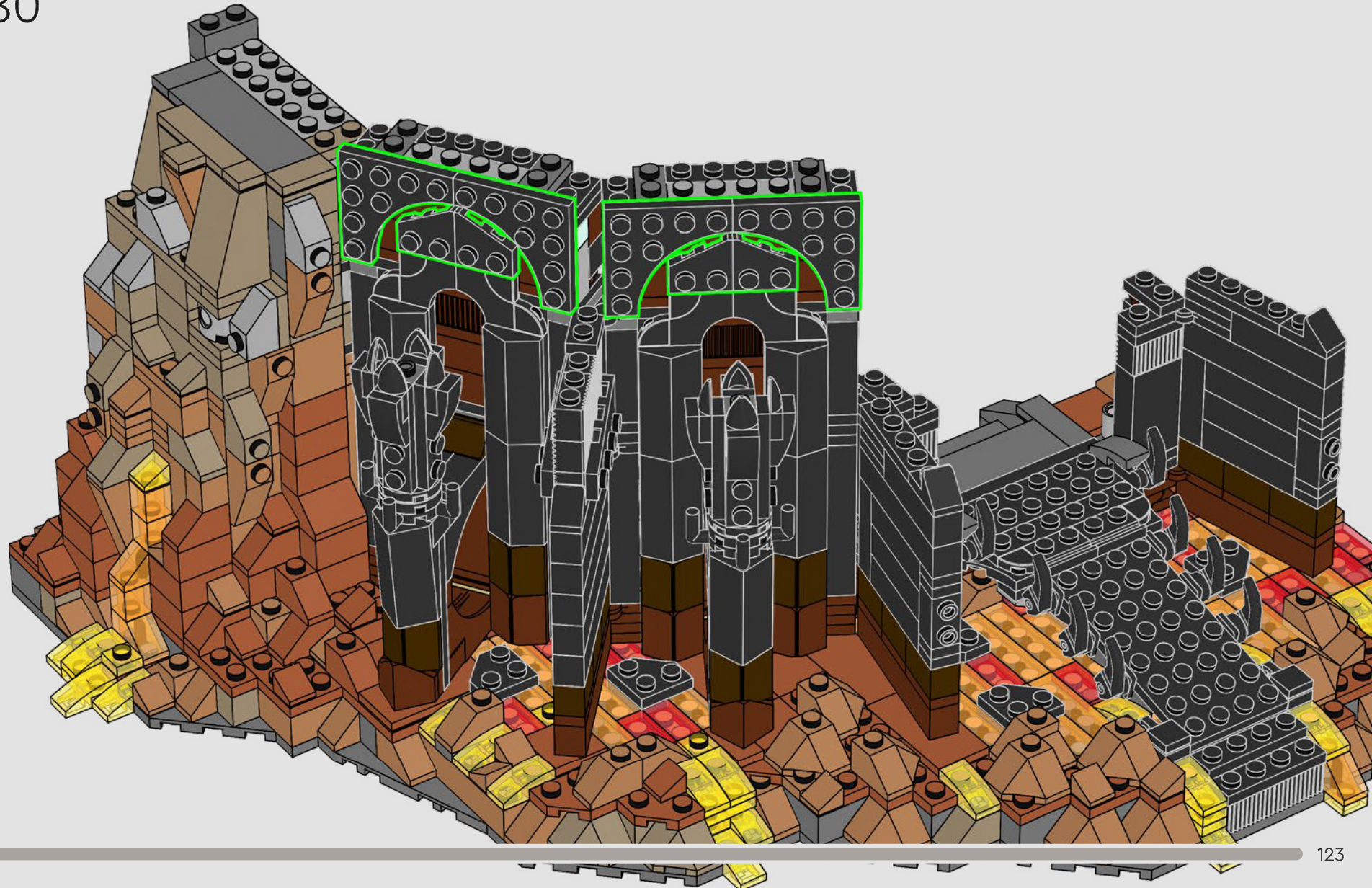

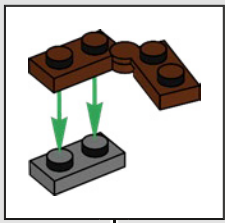
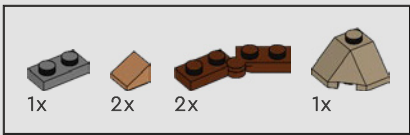

181

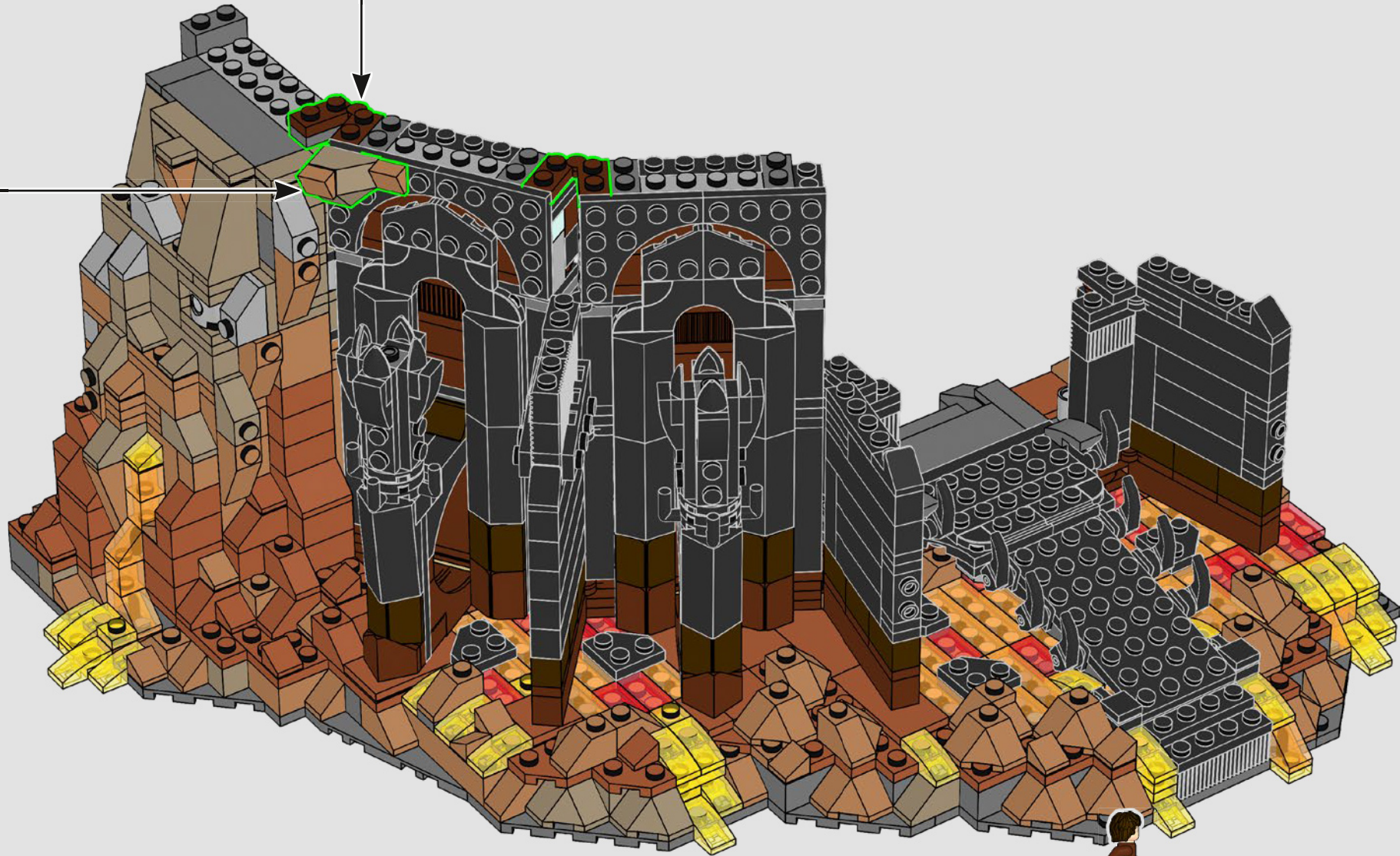
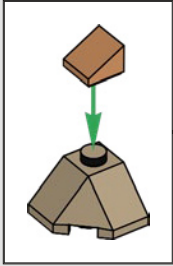

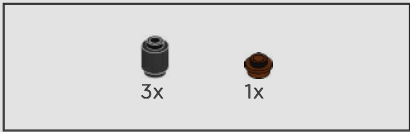

182

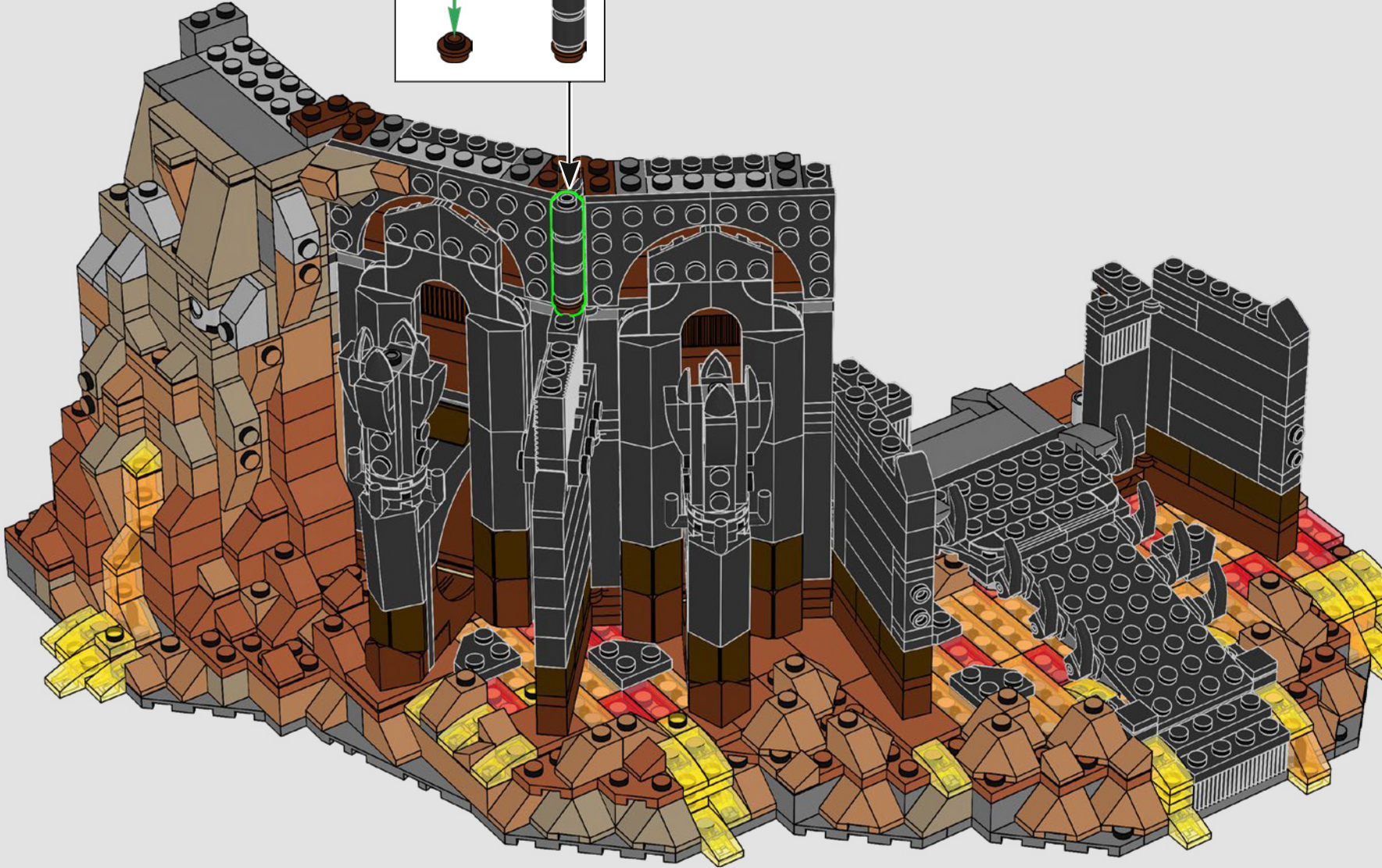
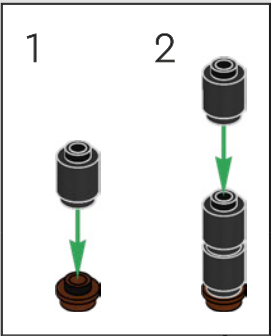



183

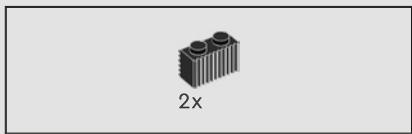
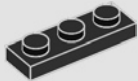

184

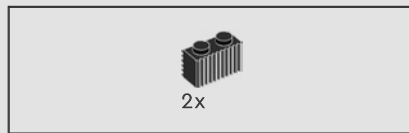
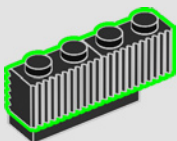

185

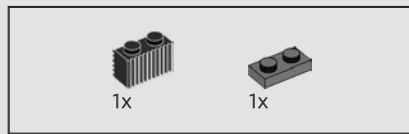
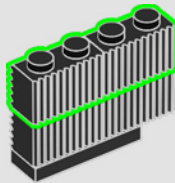

186

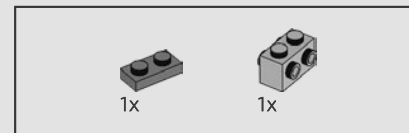
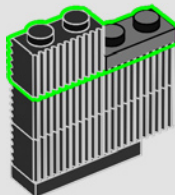

187

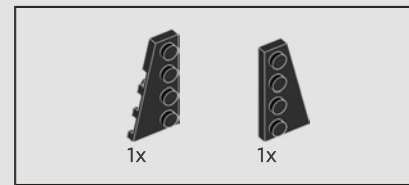
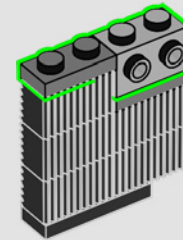

188

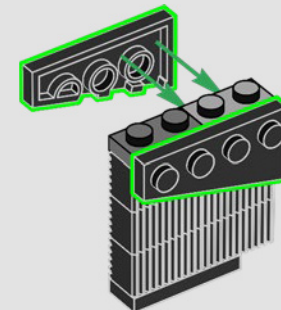



189

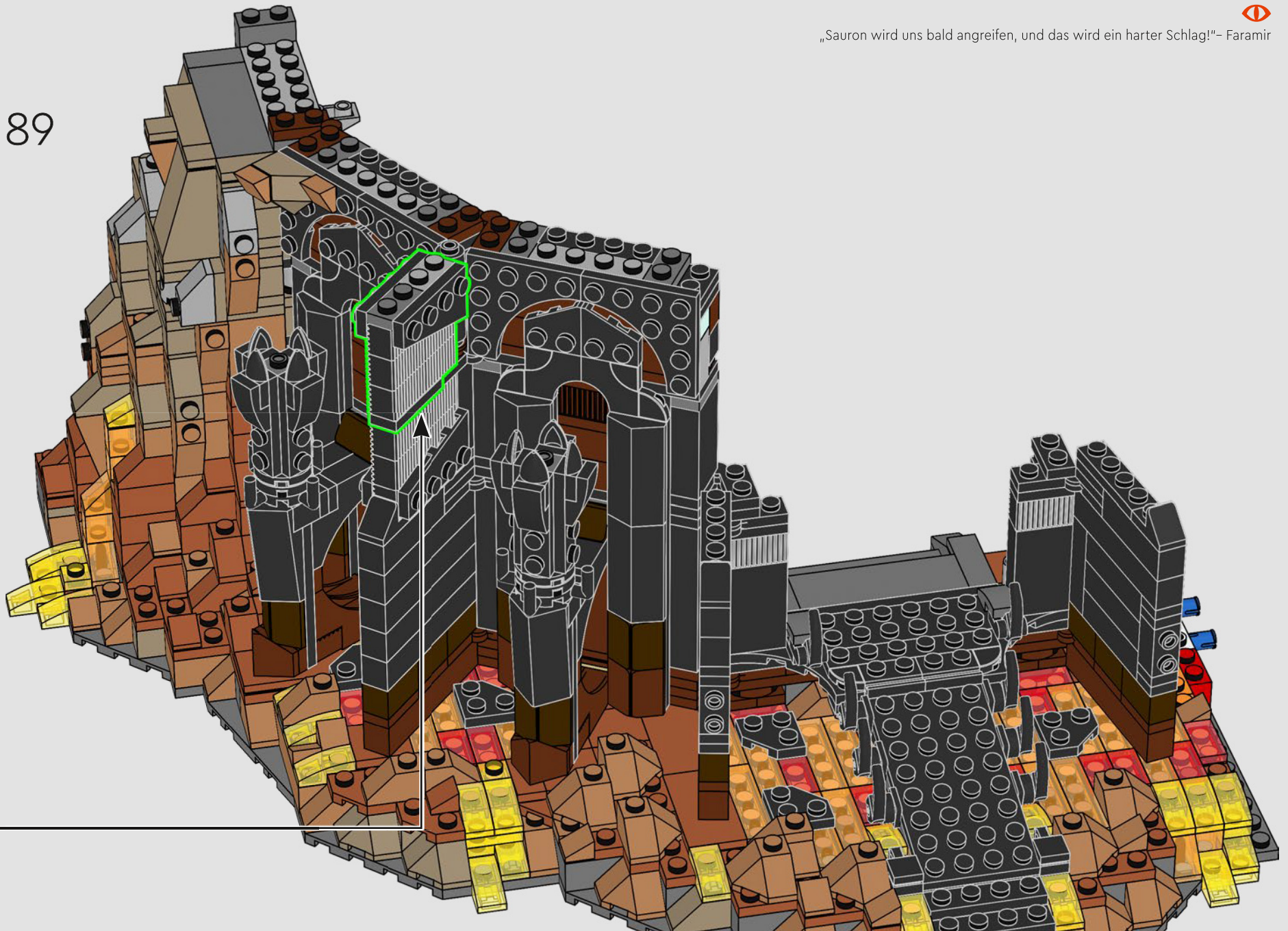

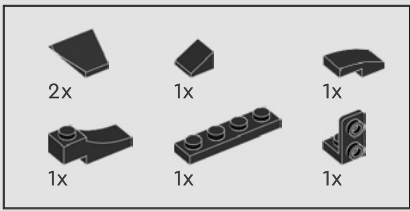

190

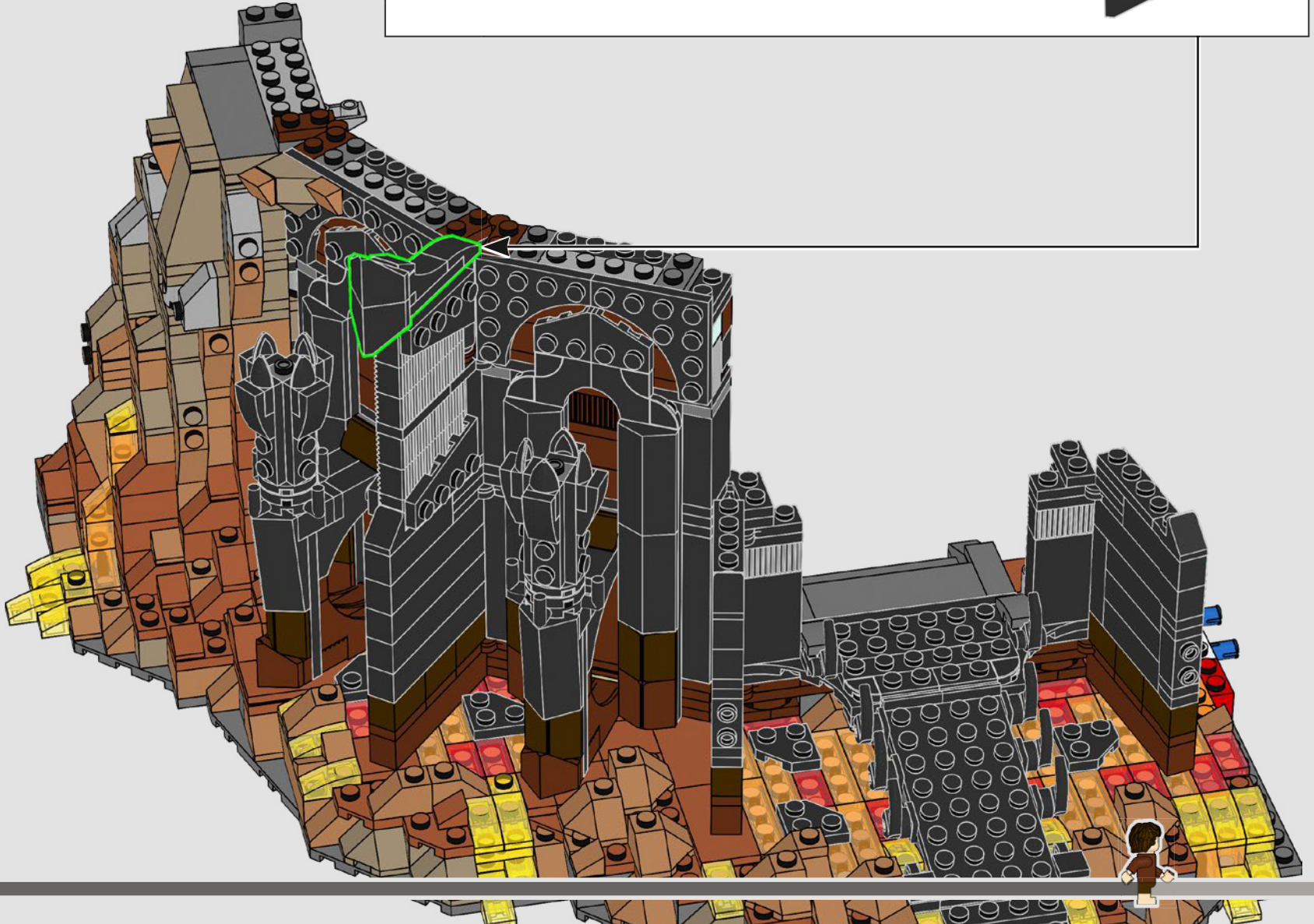
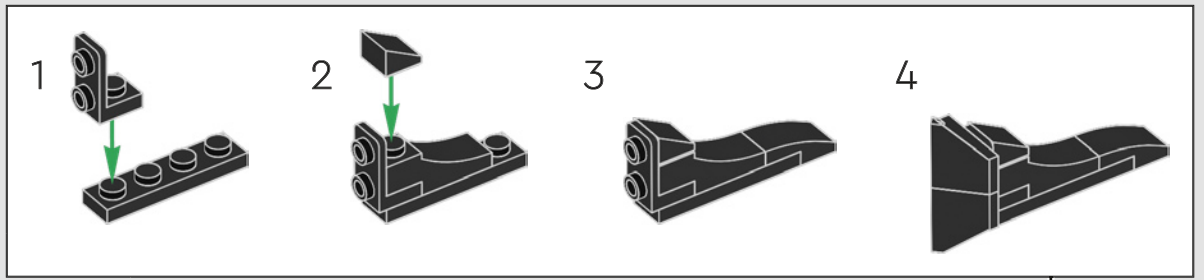

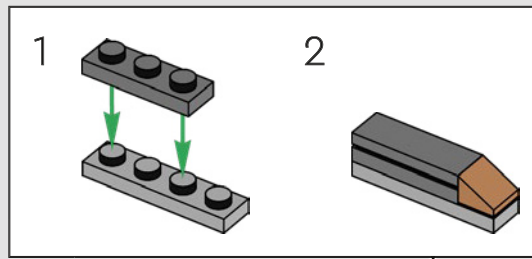
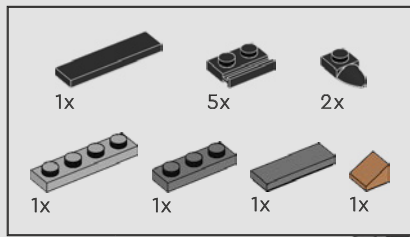

191

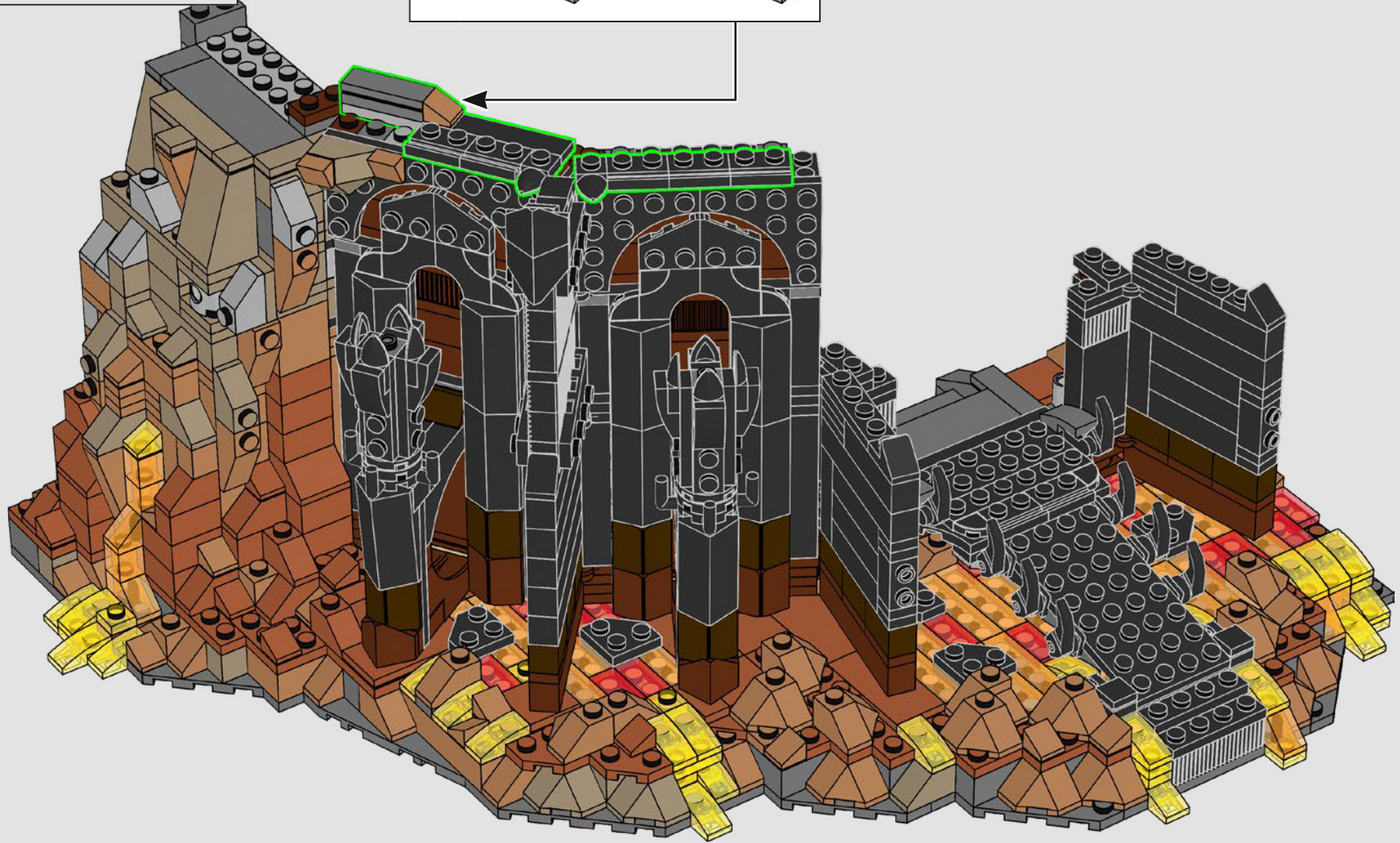

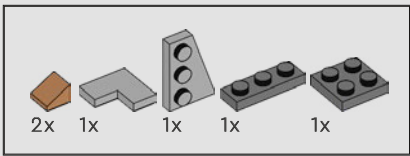

192

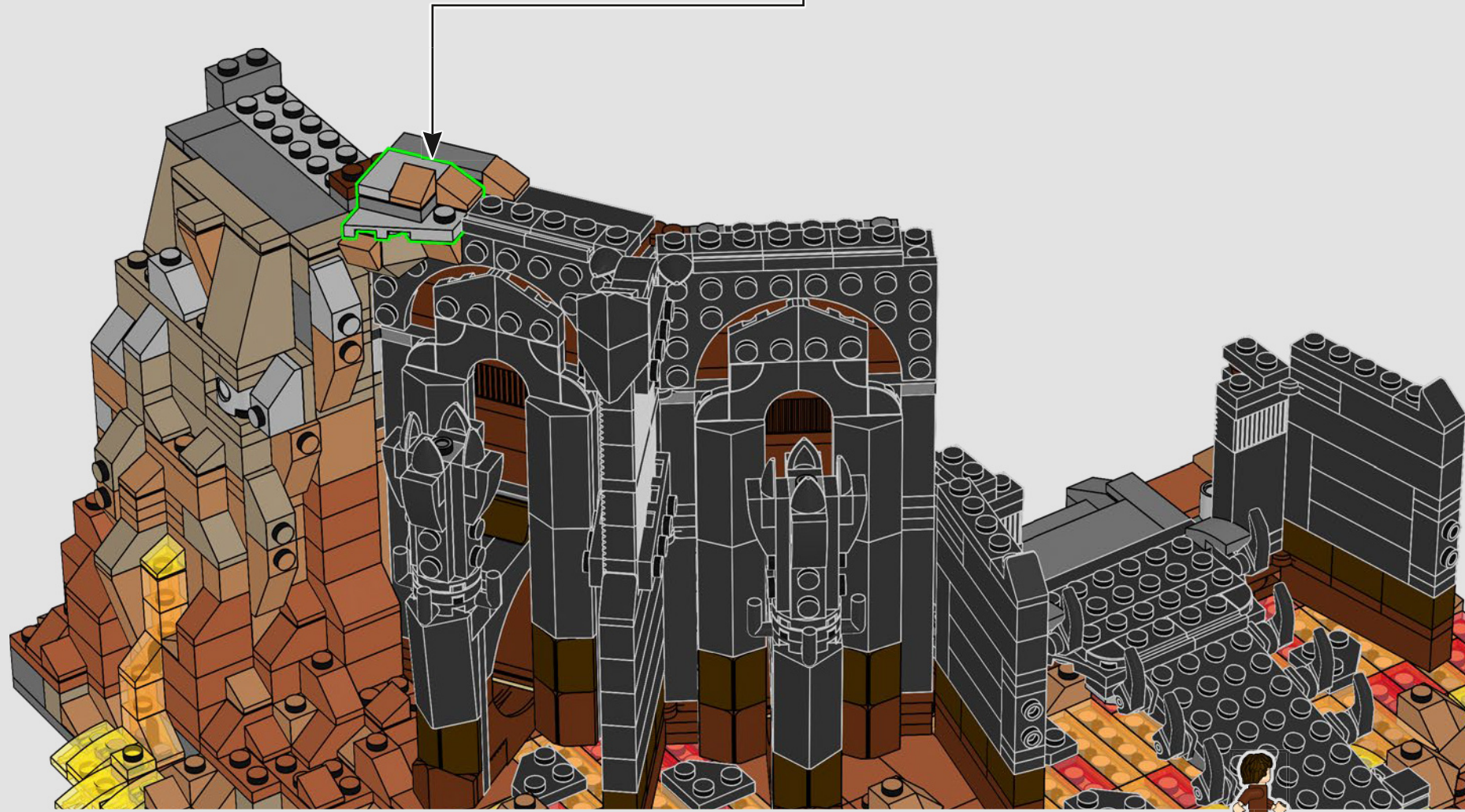
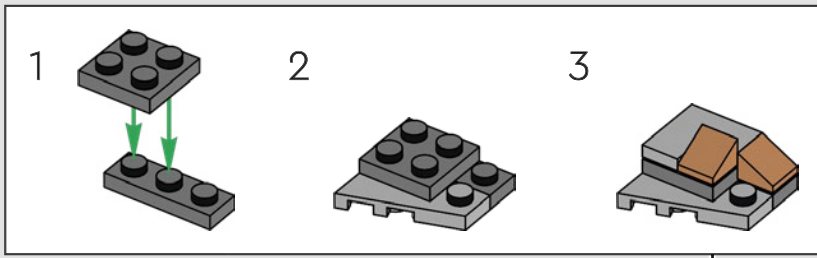

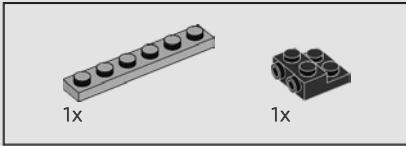
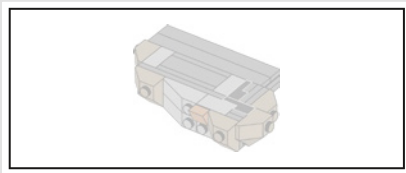

193

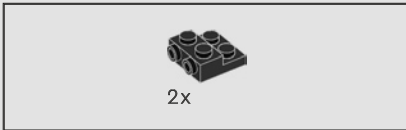
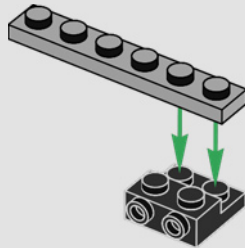

194

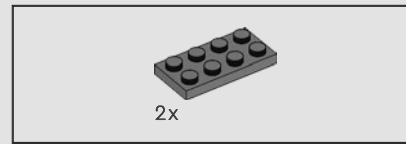
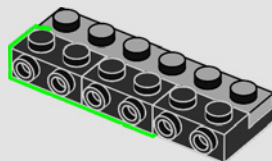

195

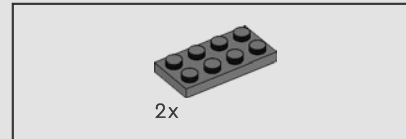
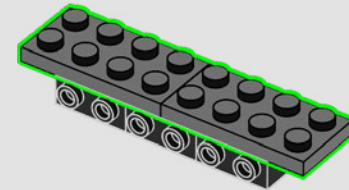

196

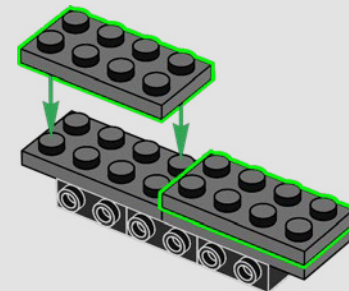

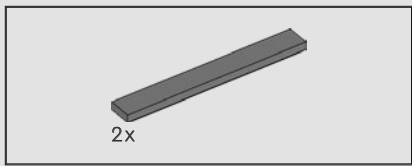

197

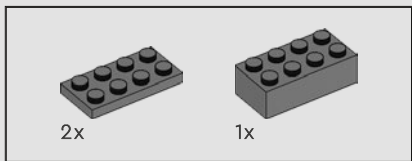
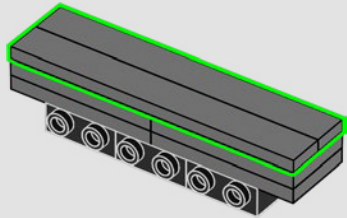

198

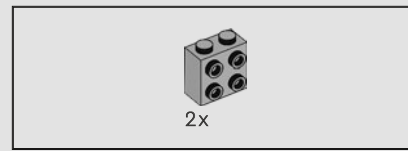
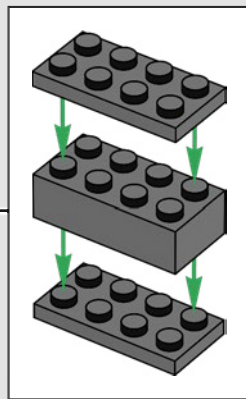
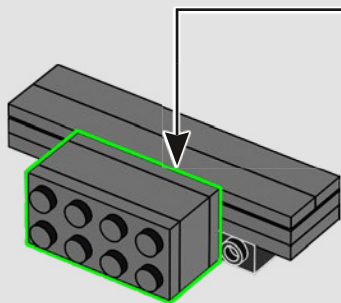

199

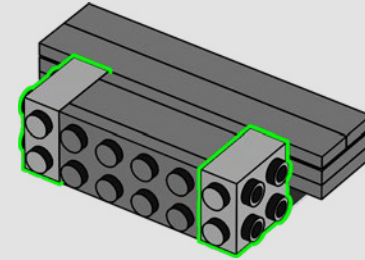

200

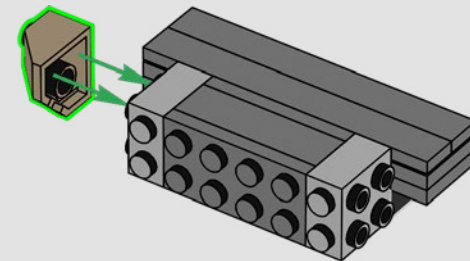

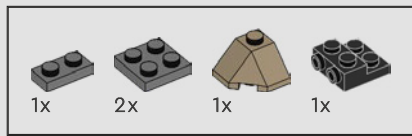

201

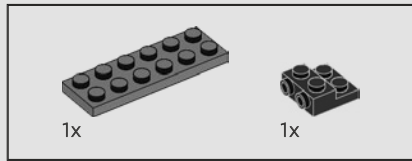
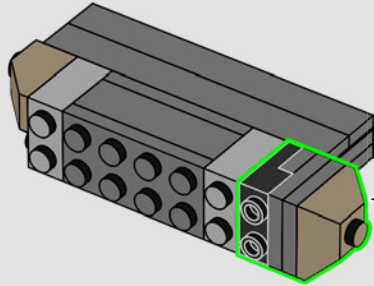
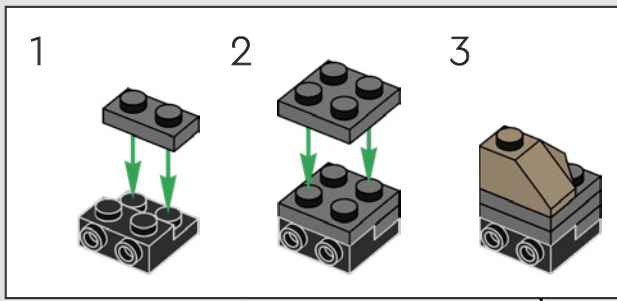

202

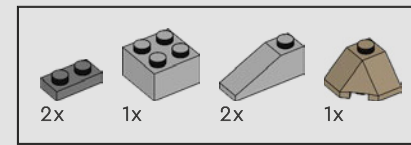
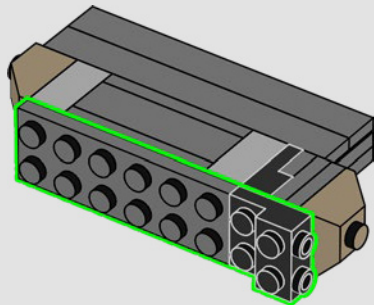

203

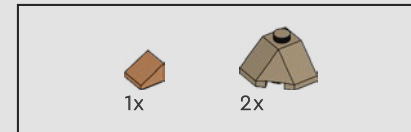
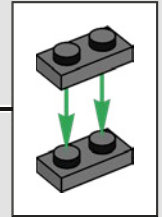
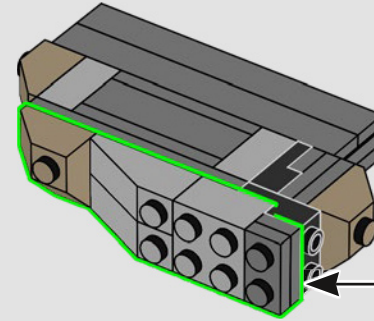

204

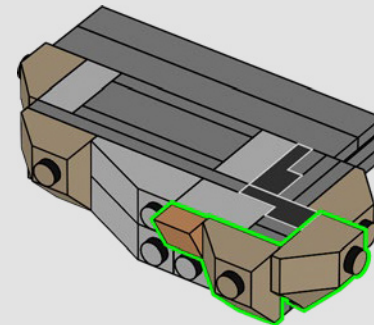

205

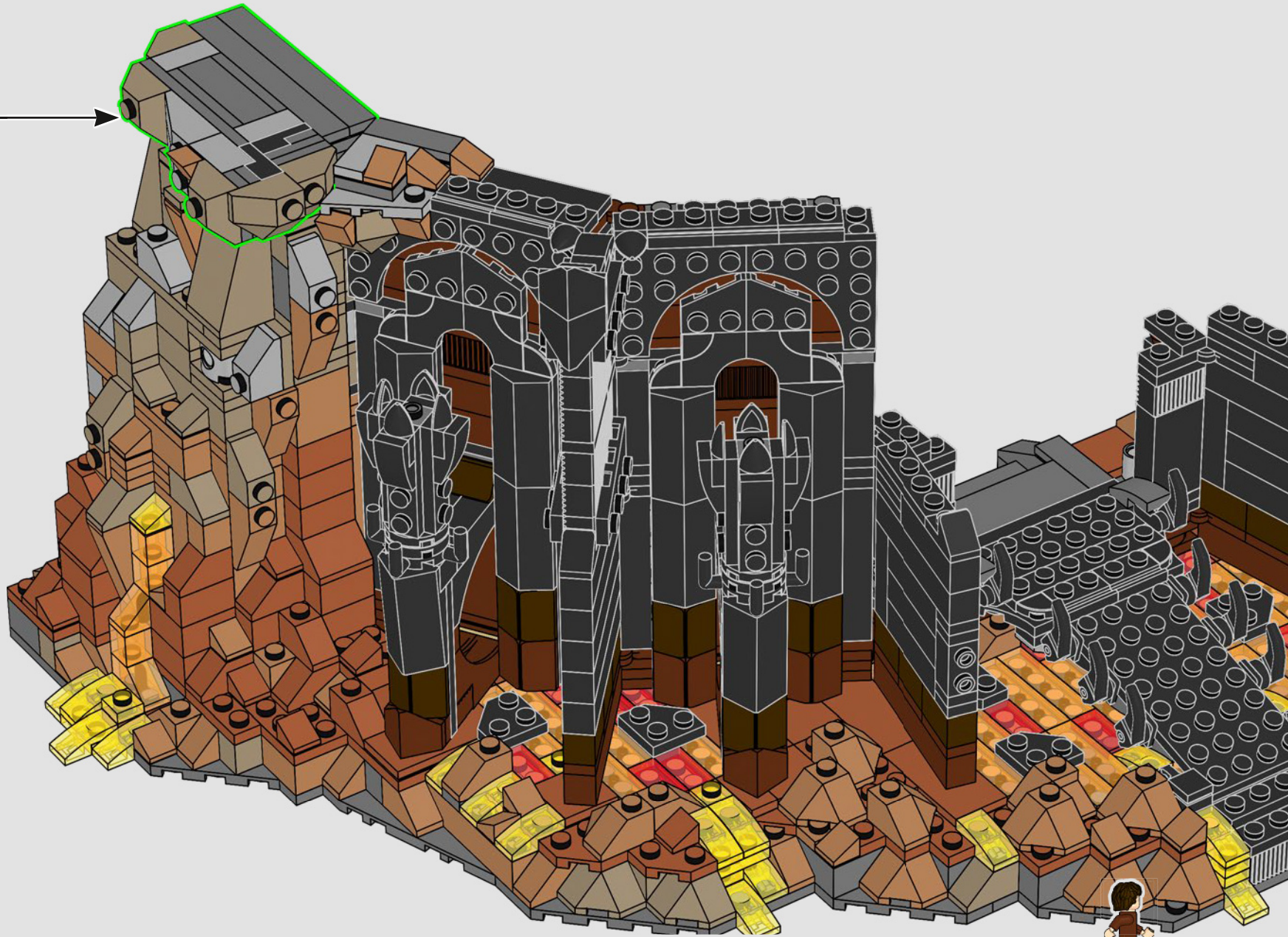

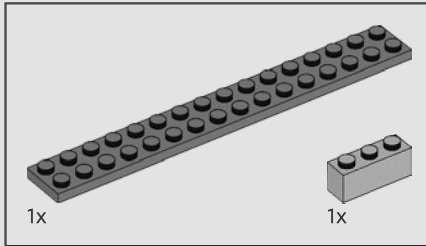
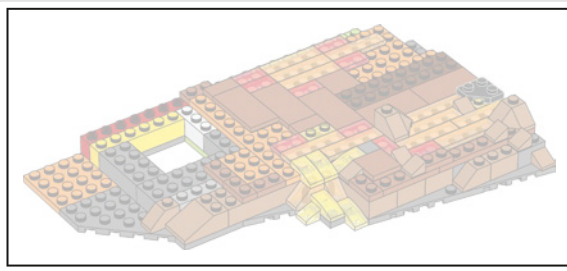

206

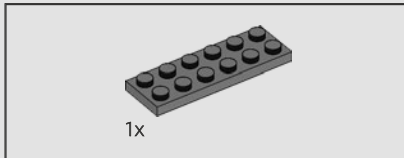
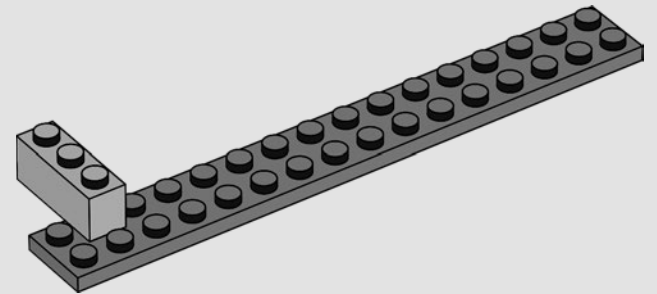

207

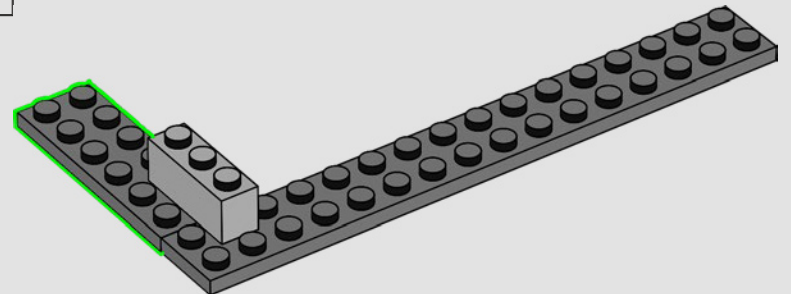

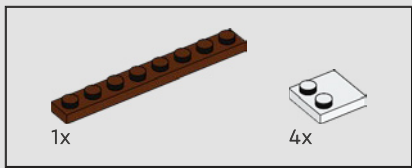

208

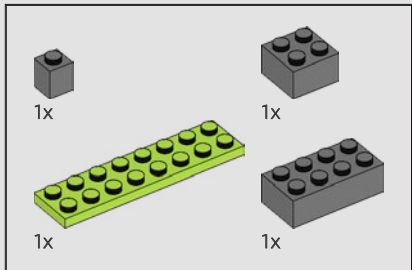
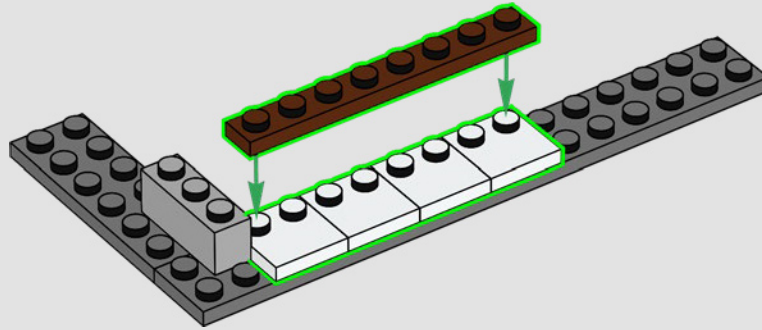

209

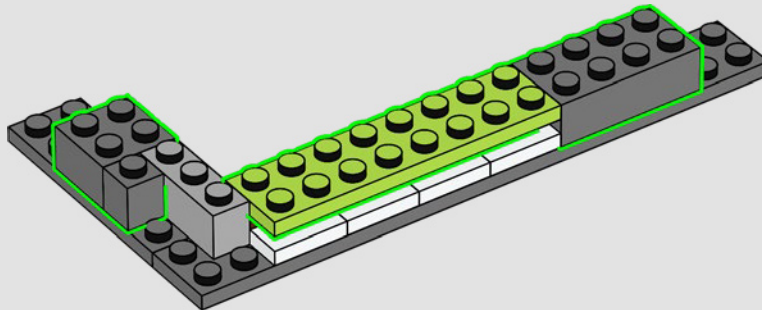

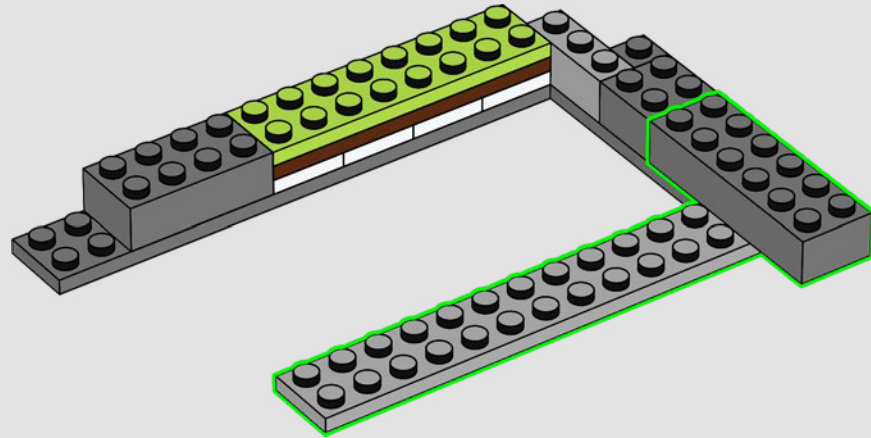
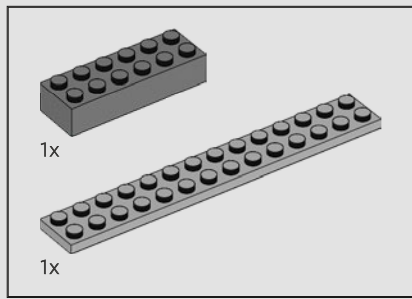

210

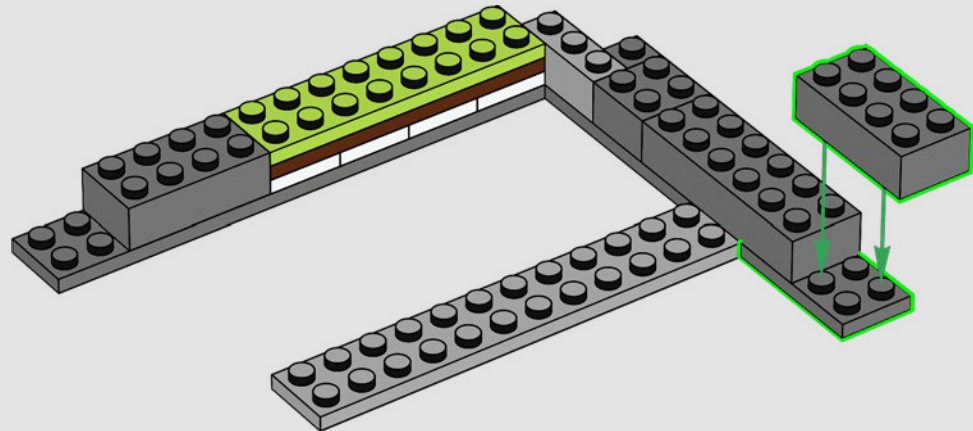
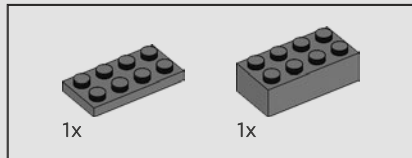

211

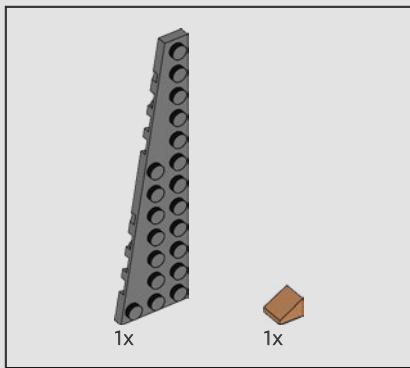

212

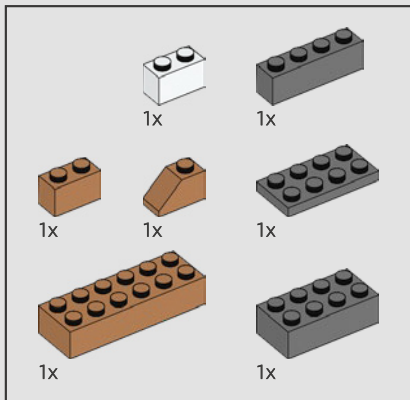
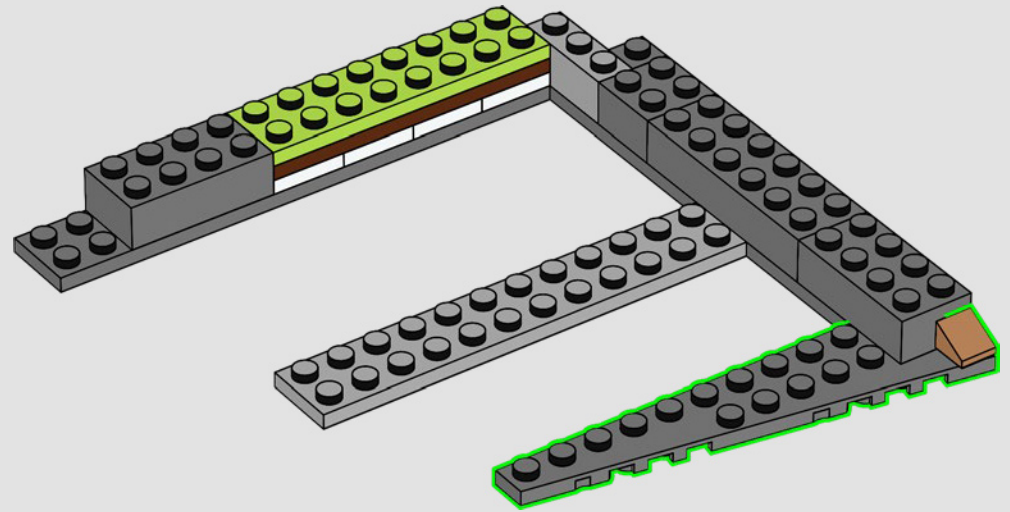

213

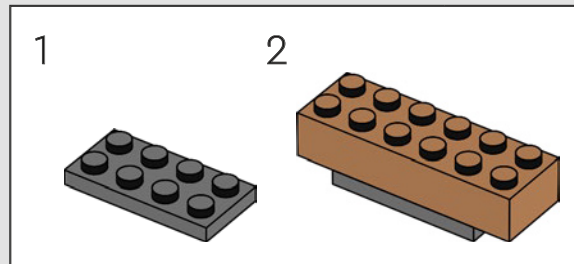
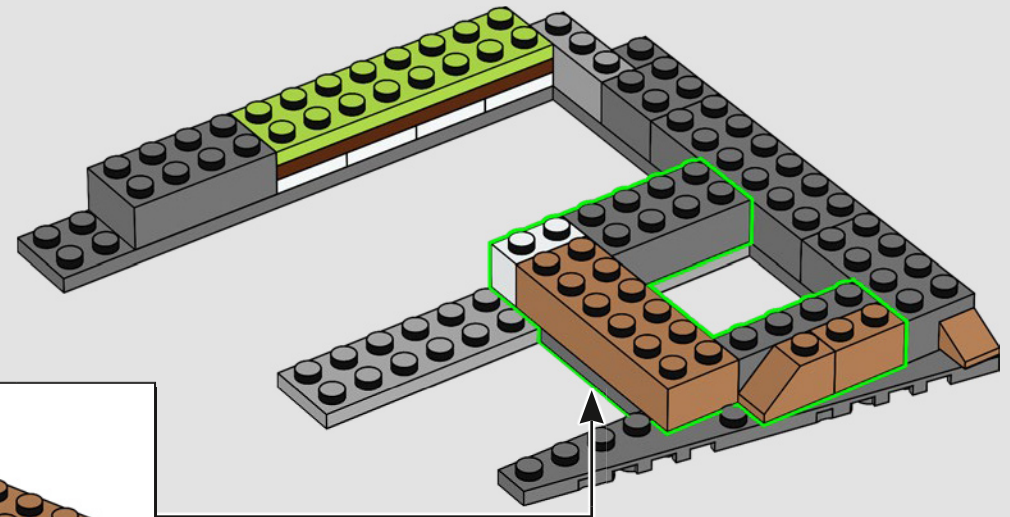

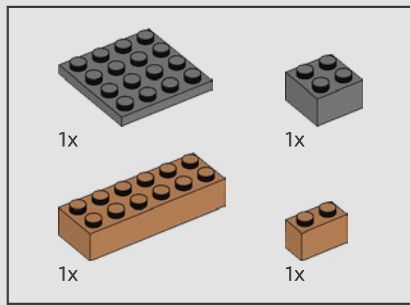

214

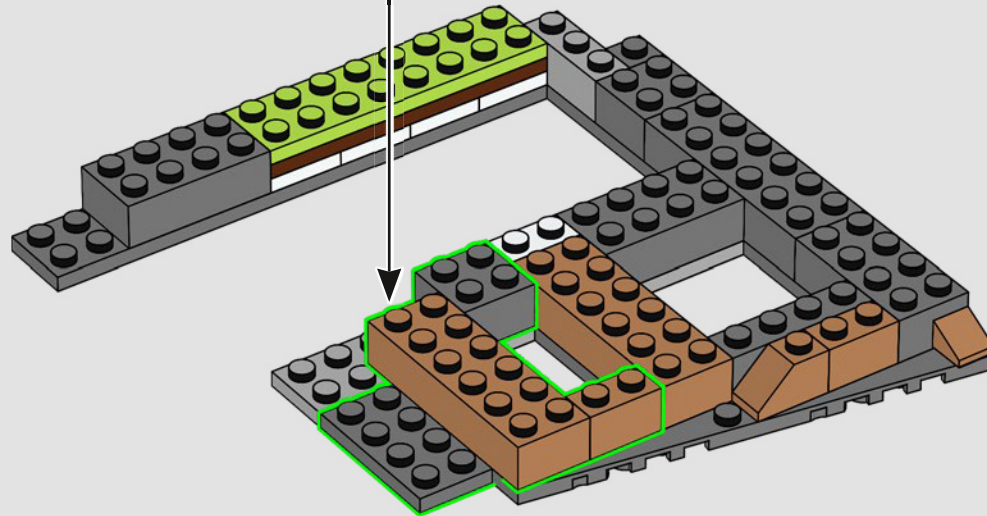
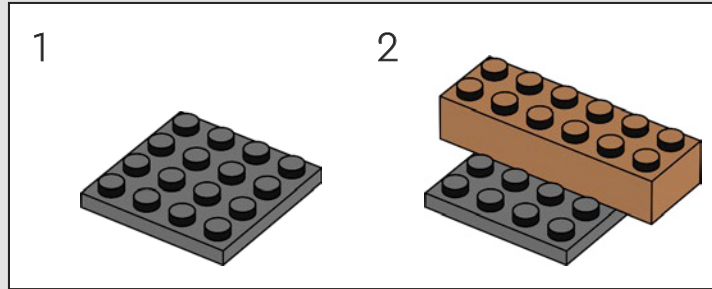

Da die Festung mithilfe der Macht des Einen Rings errichtet wurde, können die Grundmauern der Festung nicht zerstört werden, solange der Eine Ring existiert.

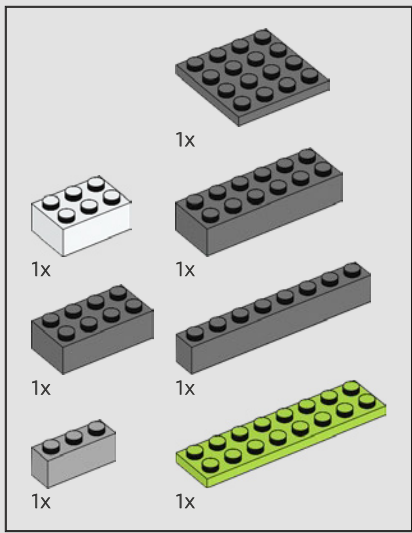

215

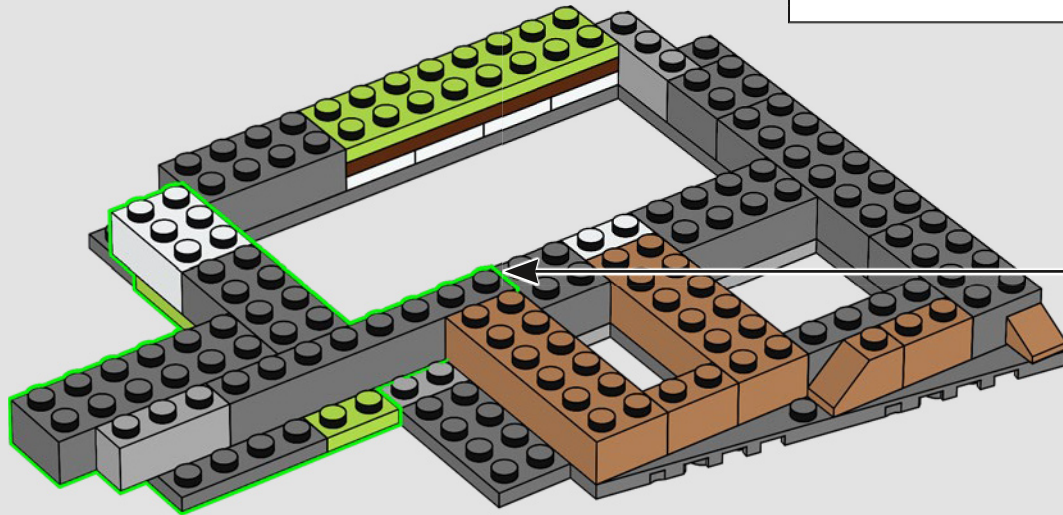
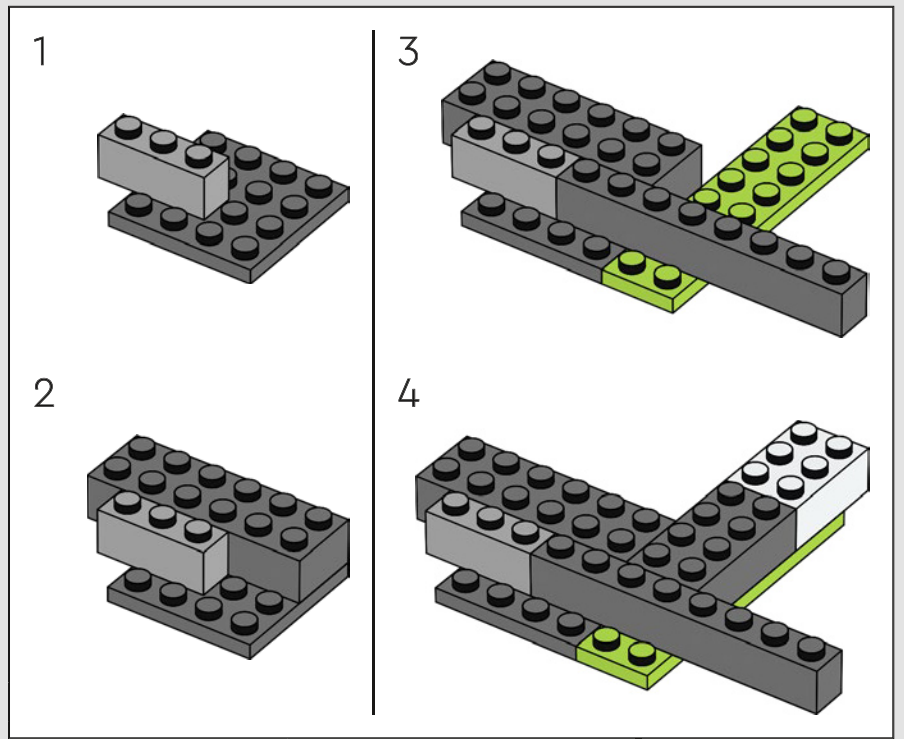

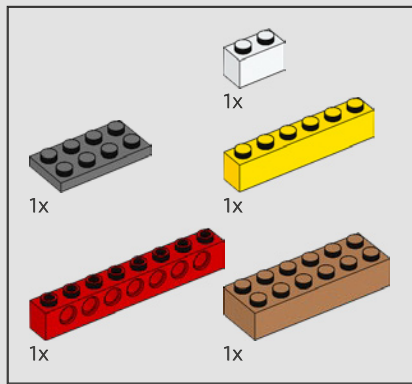

216

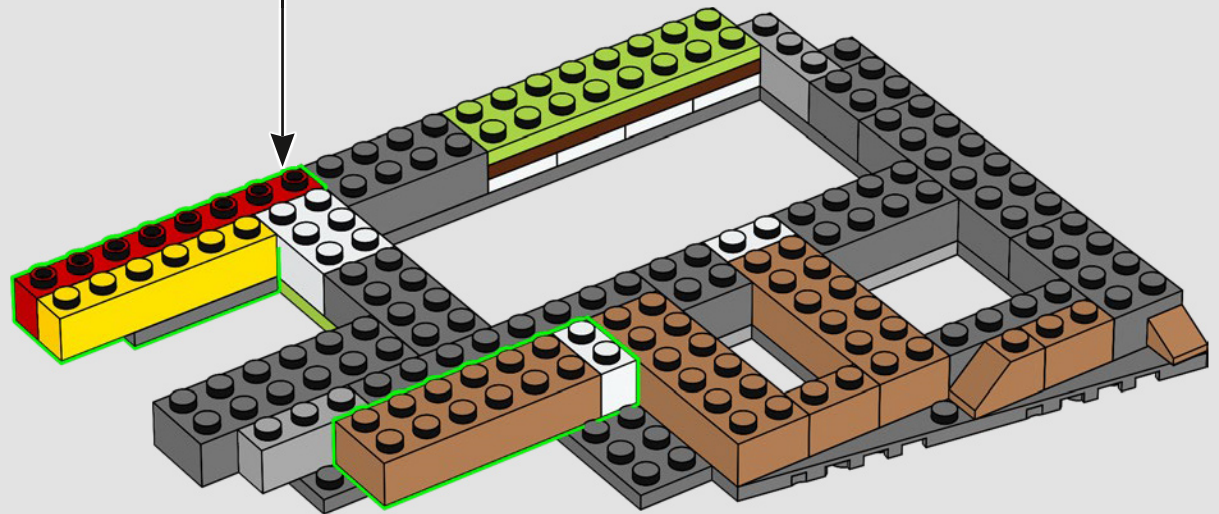
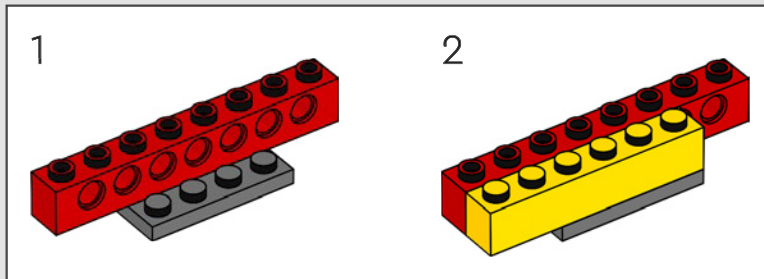

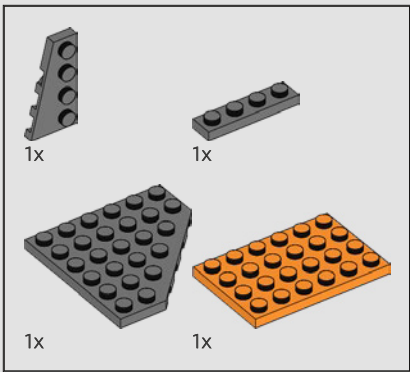

217

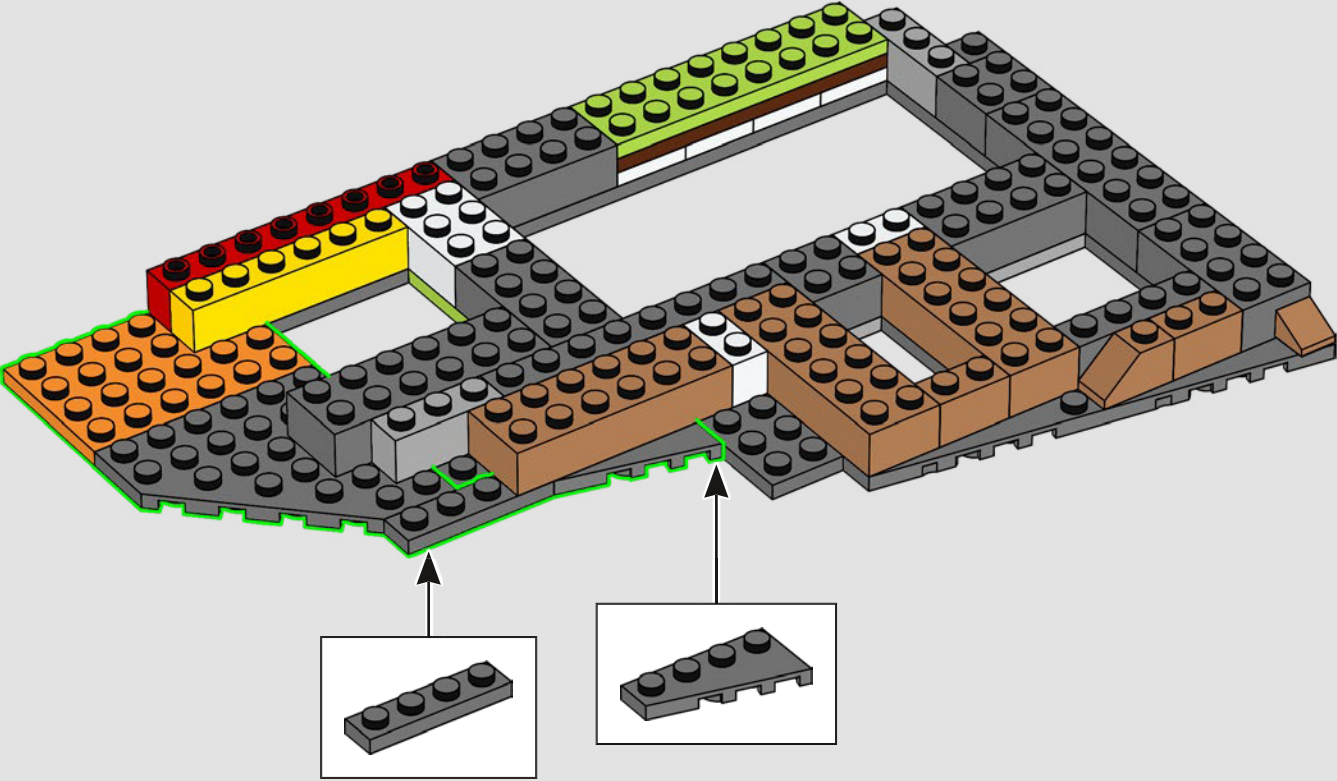

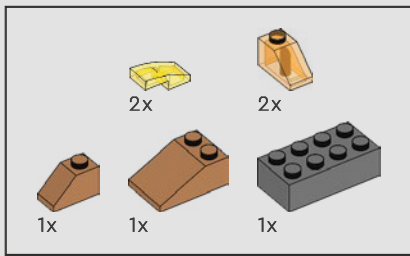

218



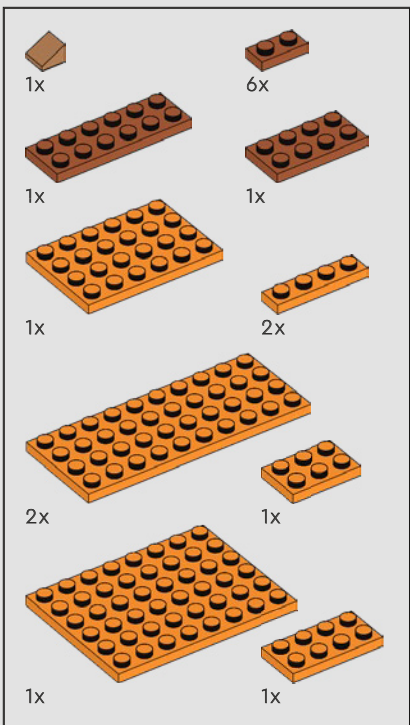

219

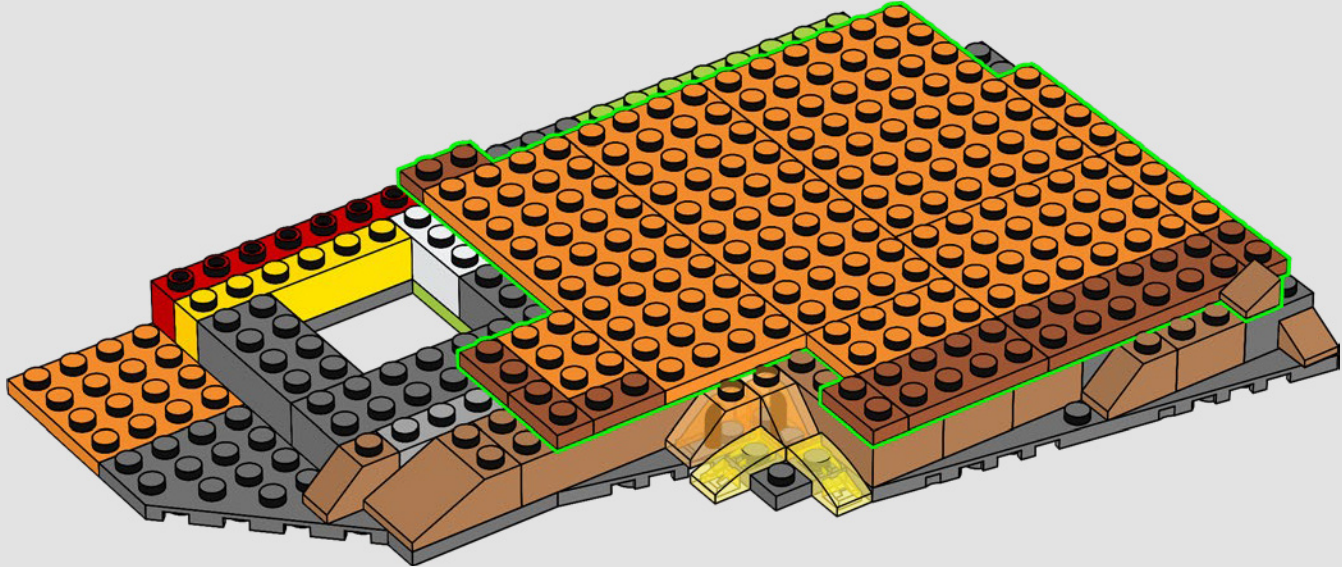

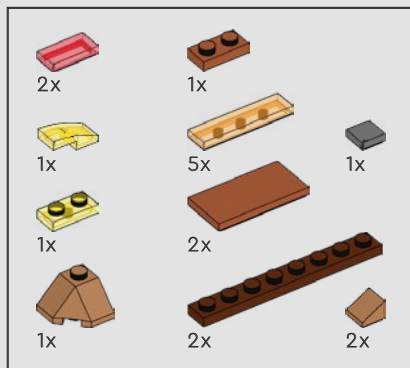

220

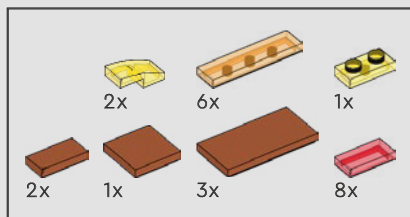
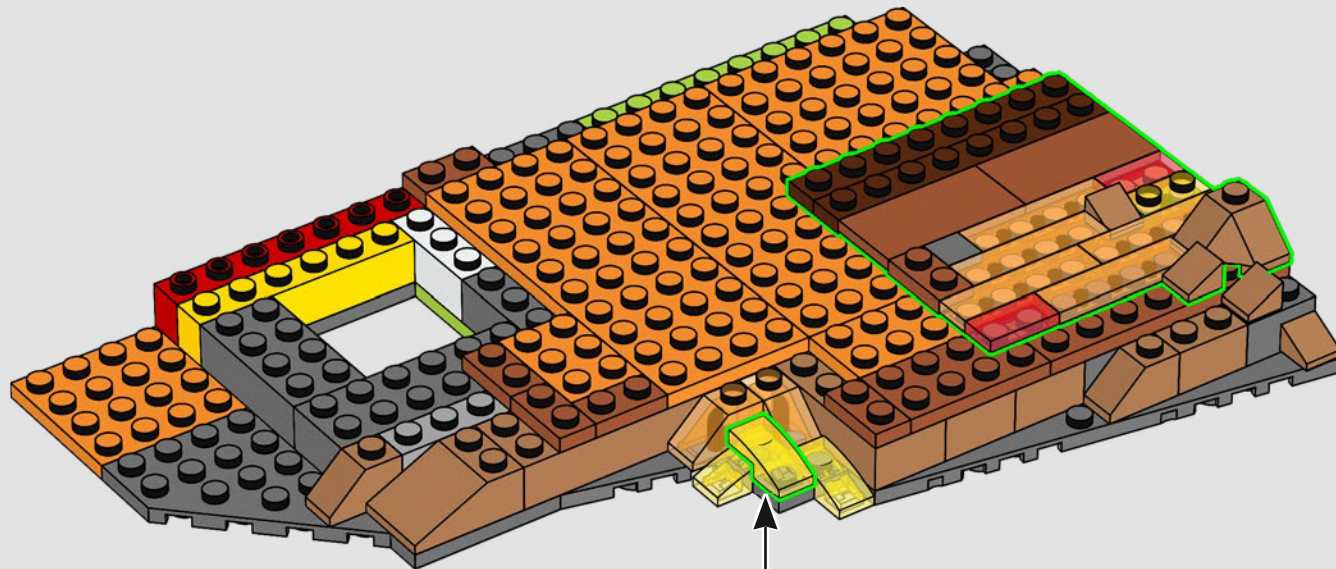

221

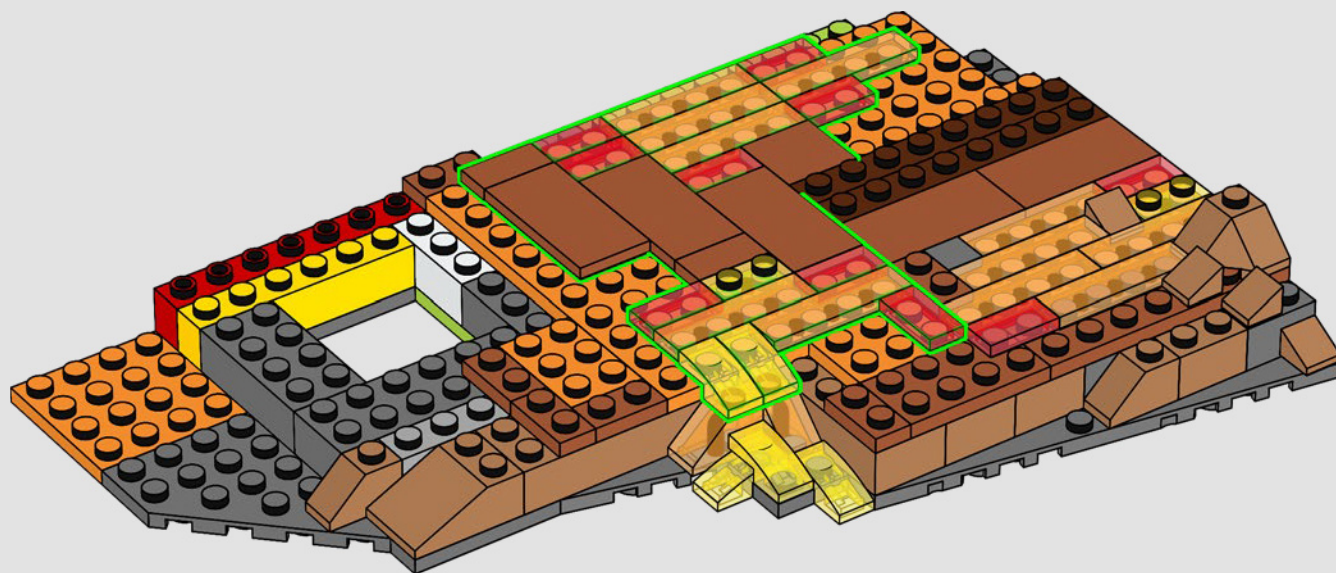



222

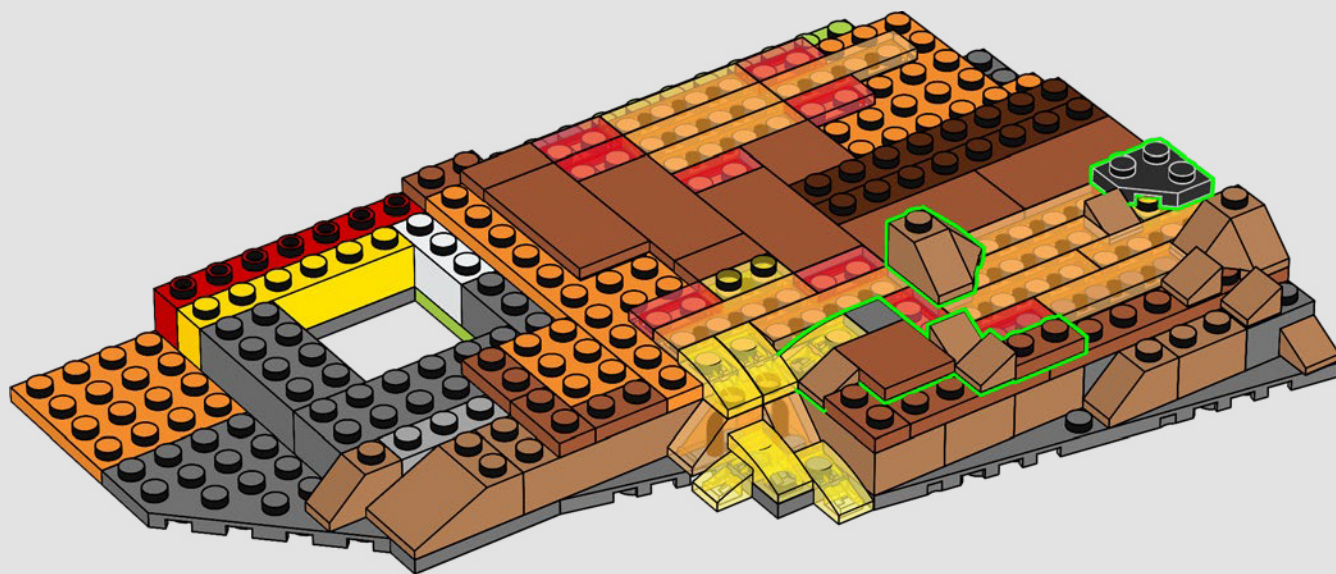

223



Das robuste Fundament des Modells wurde in vier Segmente unterteilt, um ein flüssigeres Bauerlebnis zu bieten und sich beim Bauen besser orientieren zu können.

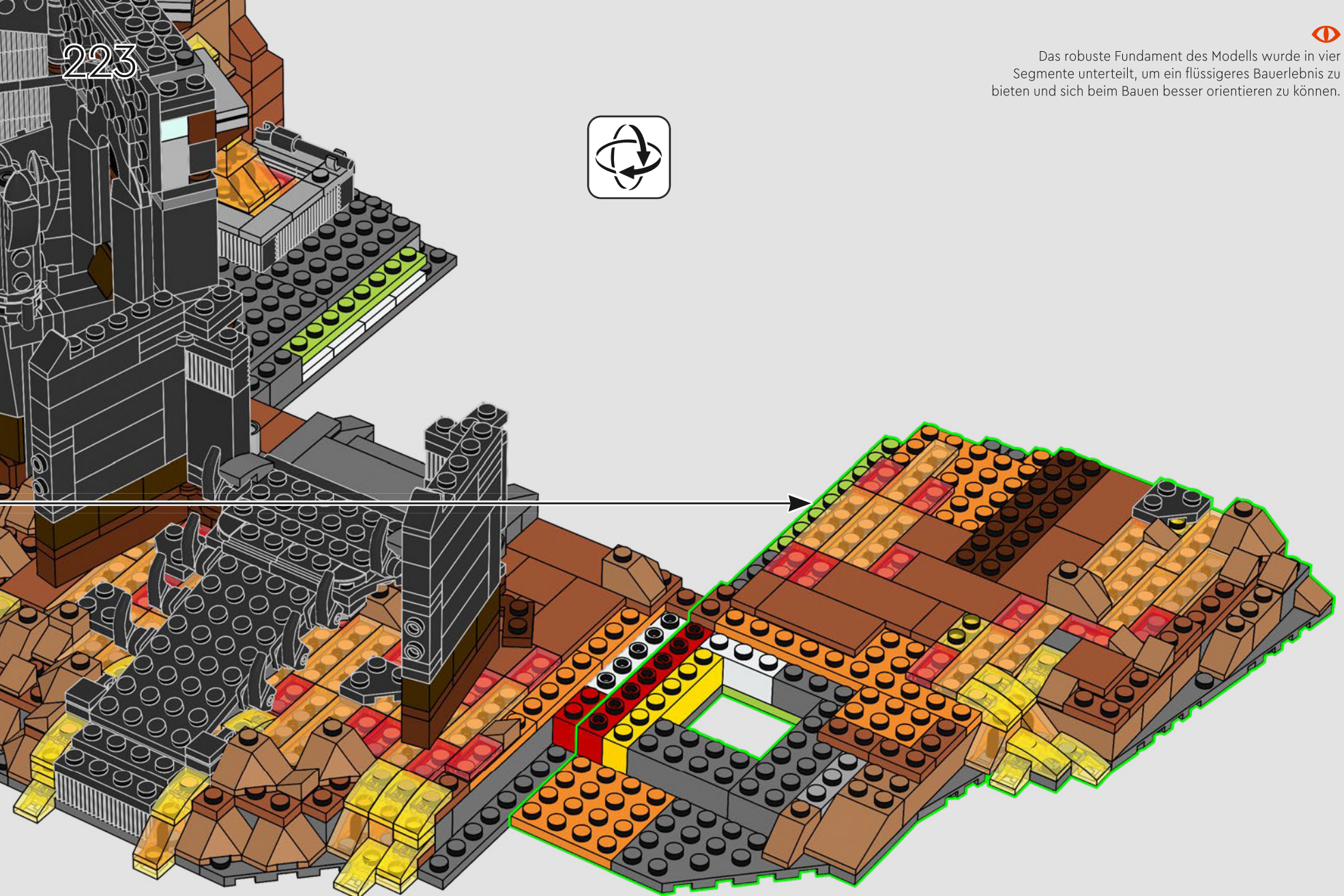

10

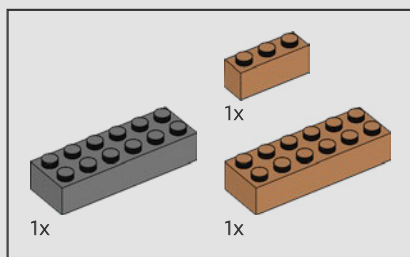

224

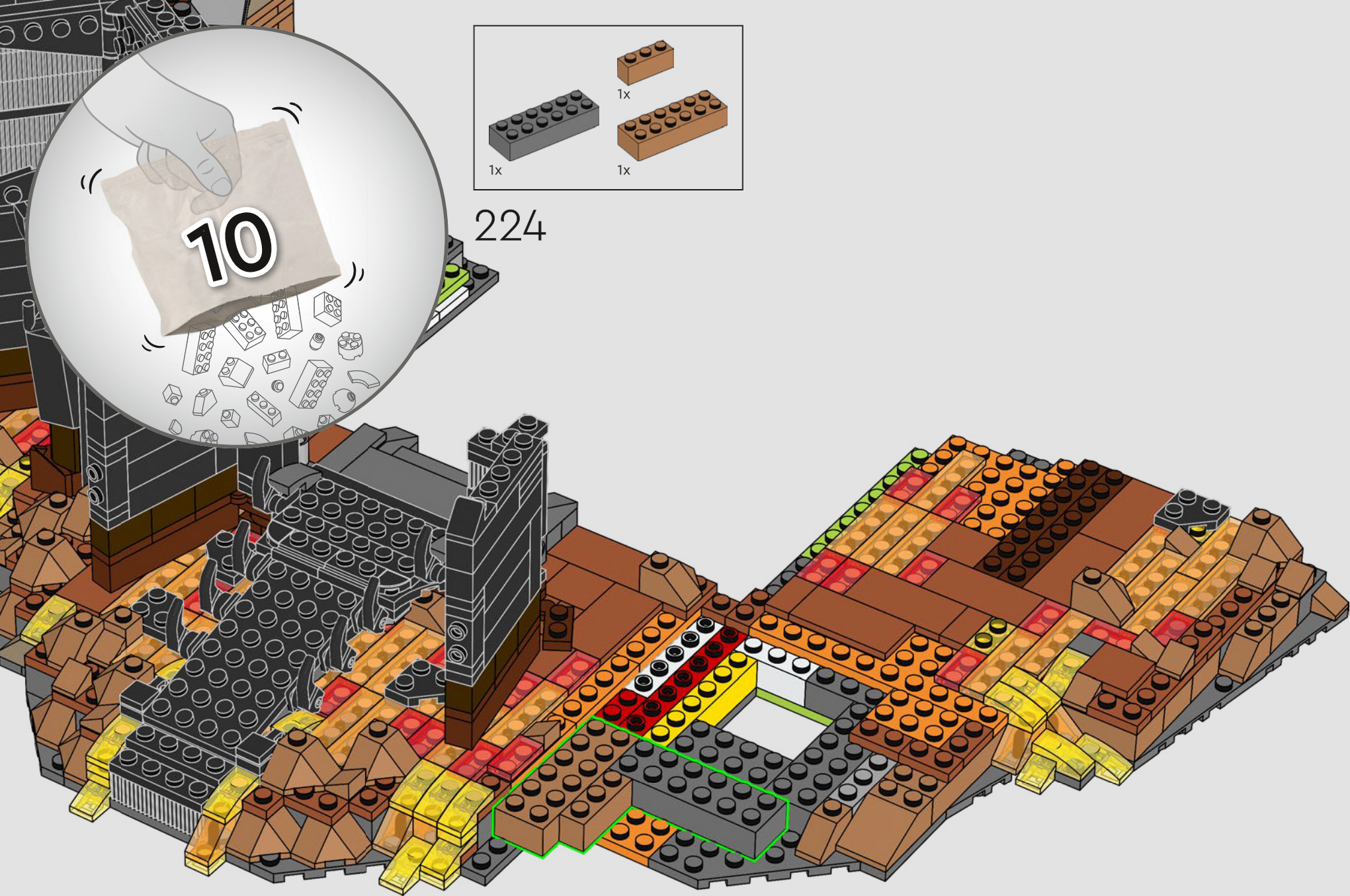

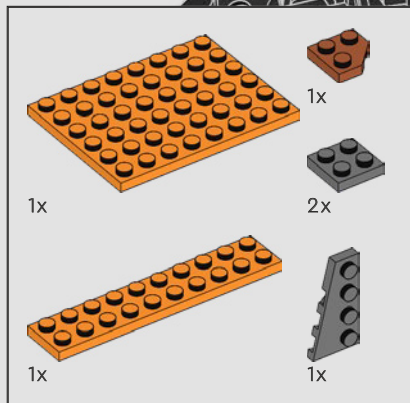

225

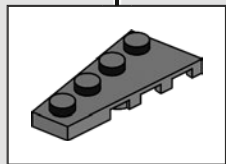
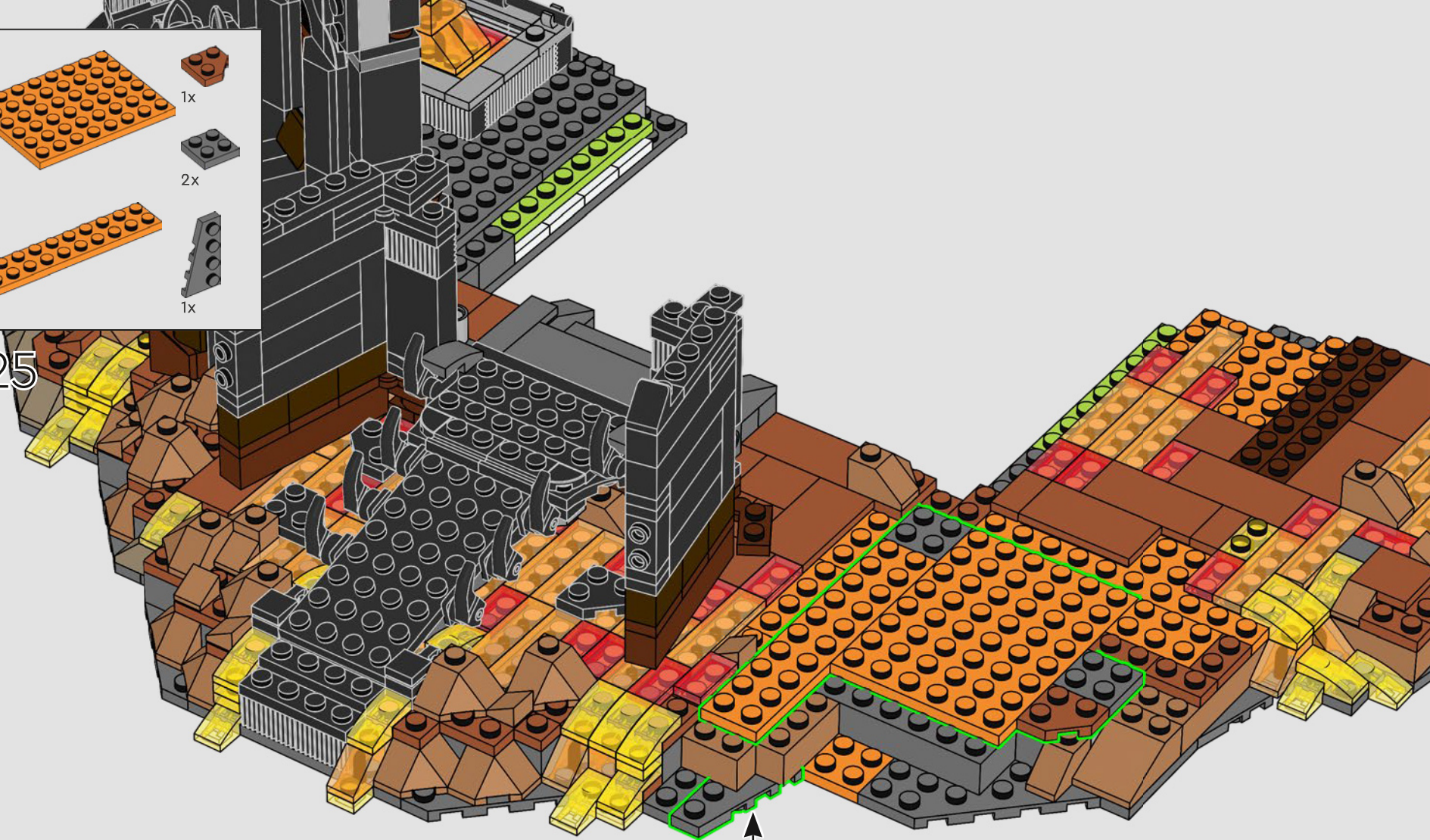



226

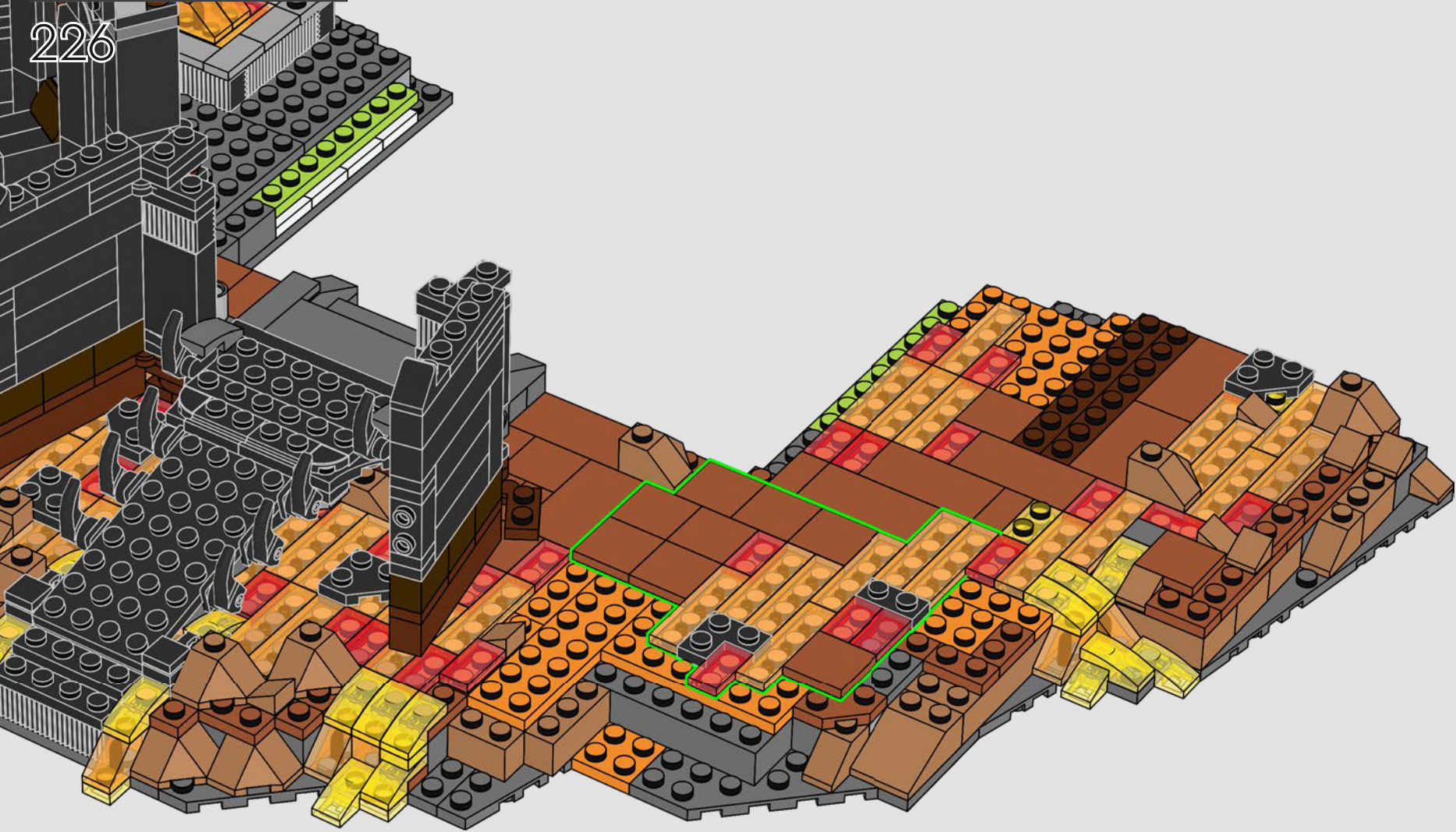

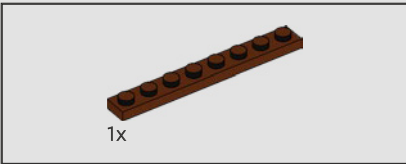
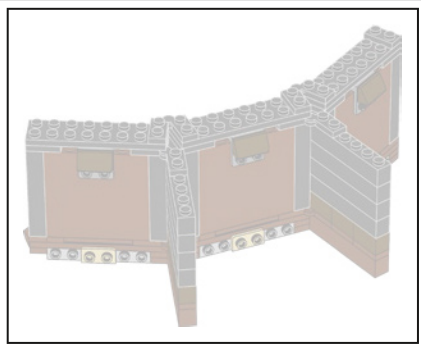

227

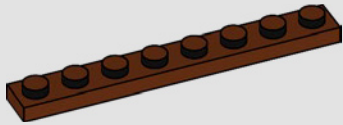

228

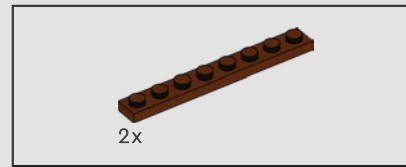
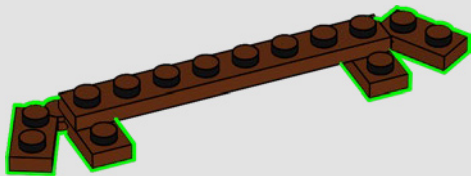

229

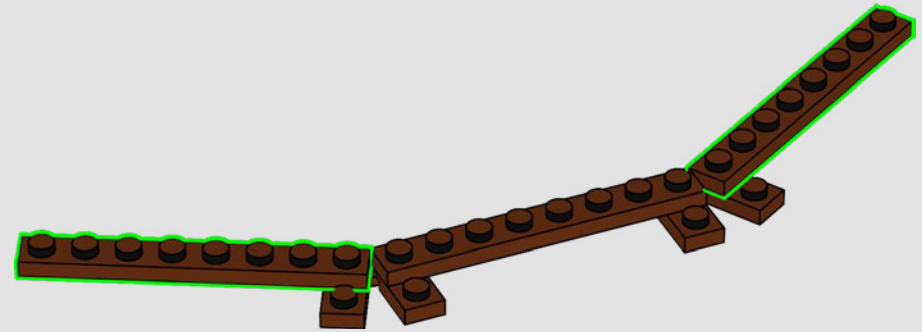

230

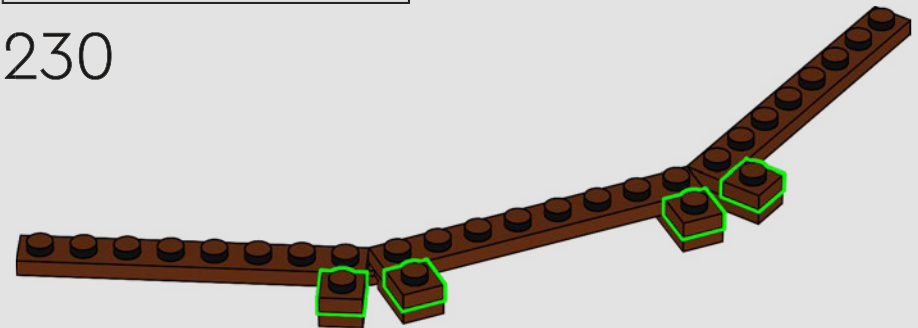

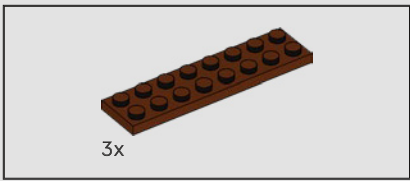

231

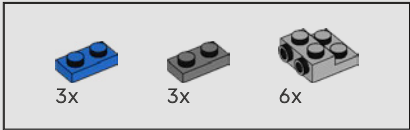
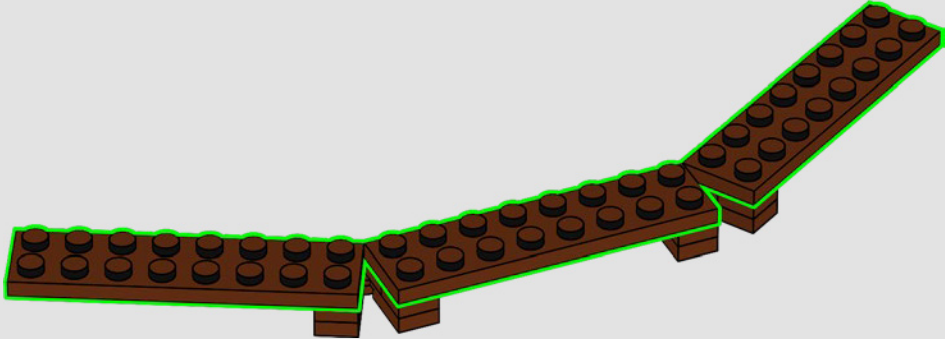

232

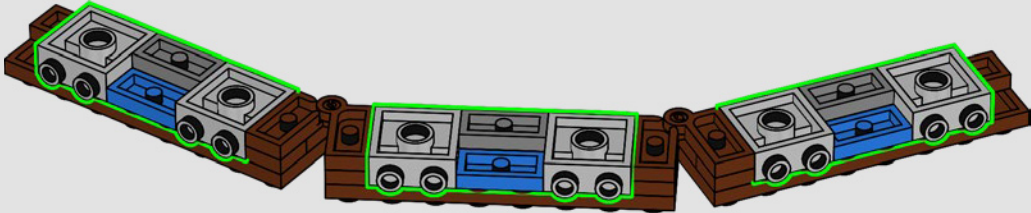



233

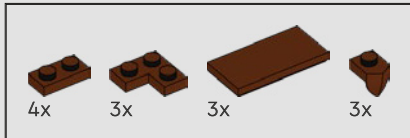
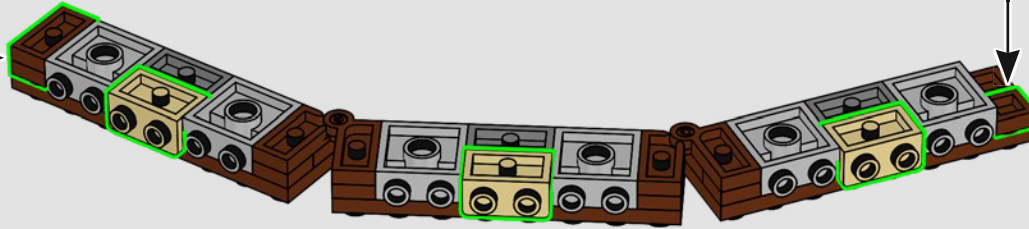
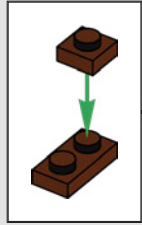

234

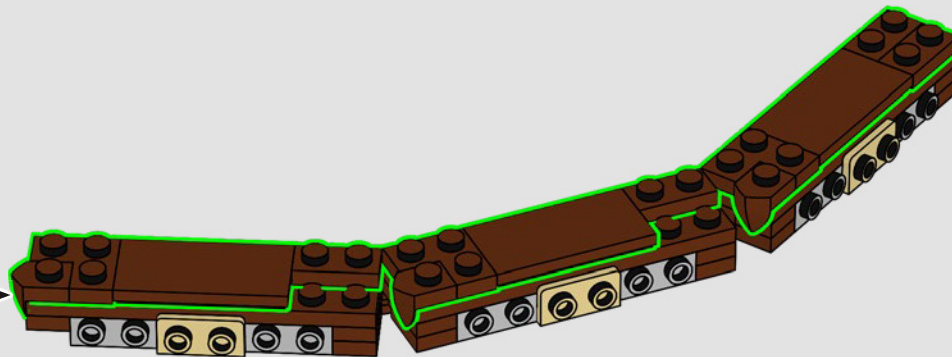

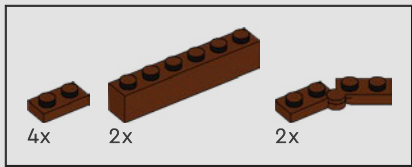

235

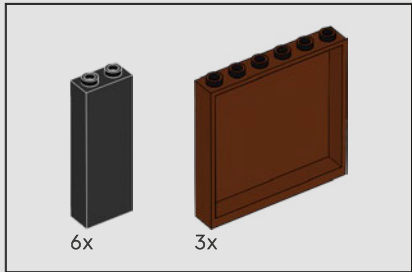
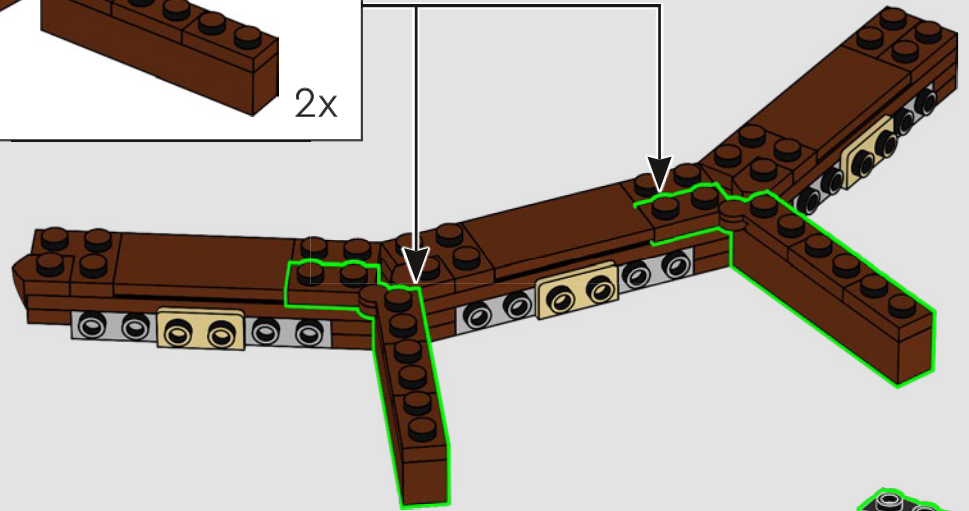
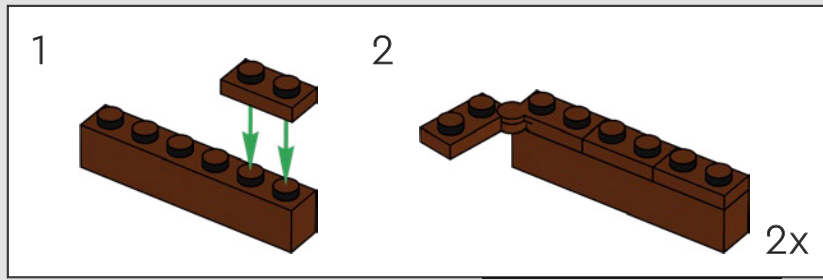

236

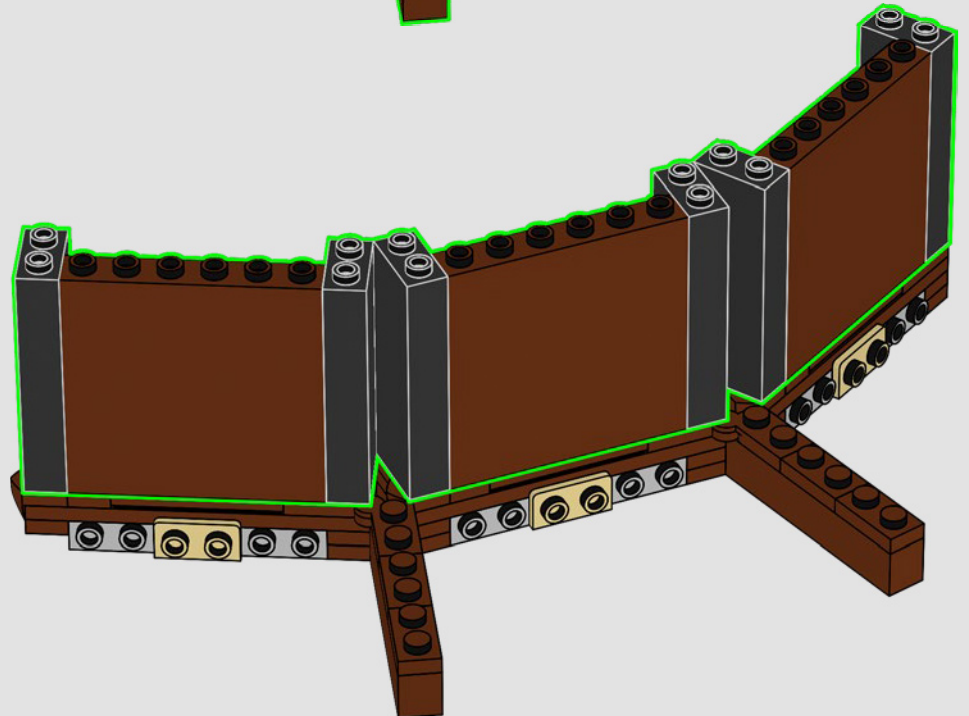

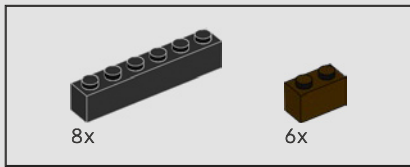

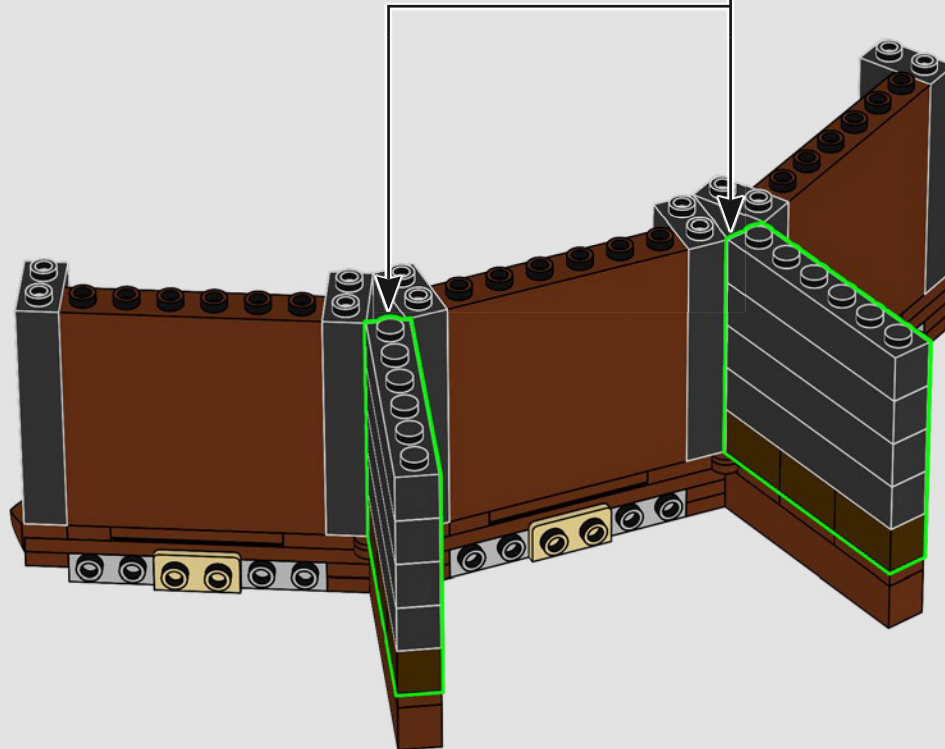
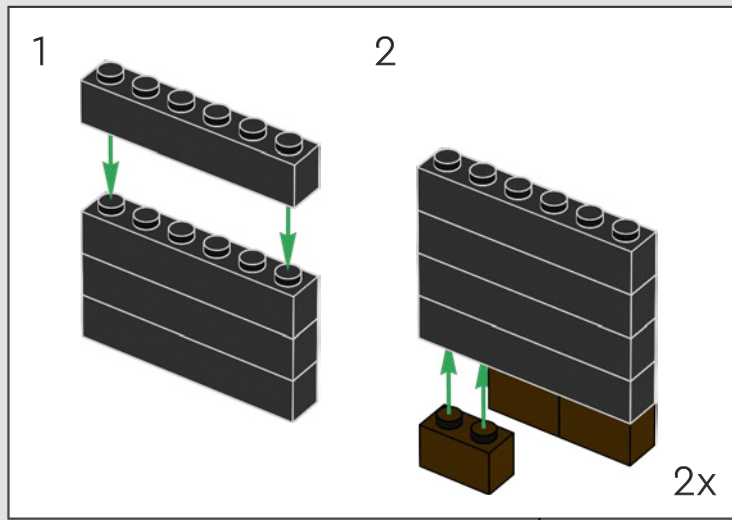

237

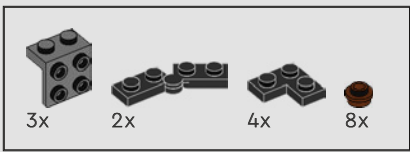

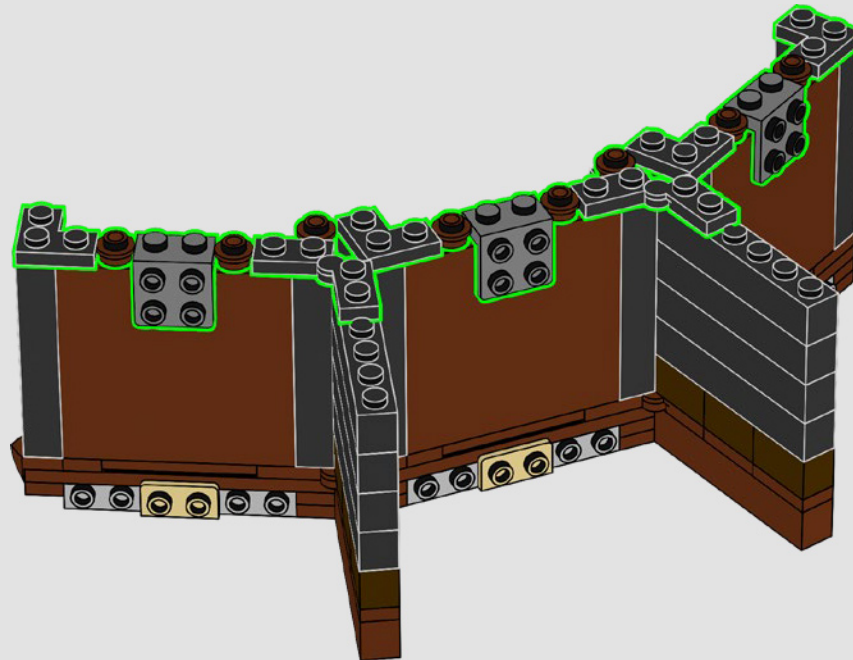

238



 Bei diesem Modell werden Scharniere verwendet, um der Festung ihre einzigartige Form zu verleihen. Jede Etage wurde mit anderen Winkeln gestaltet.

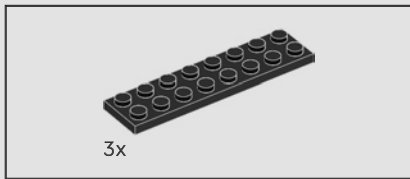

239

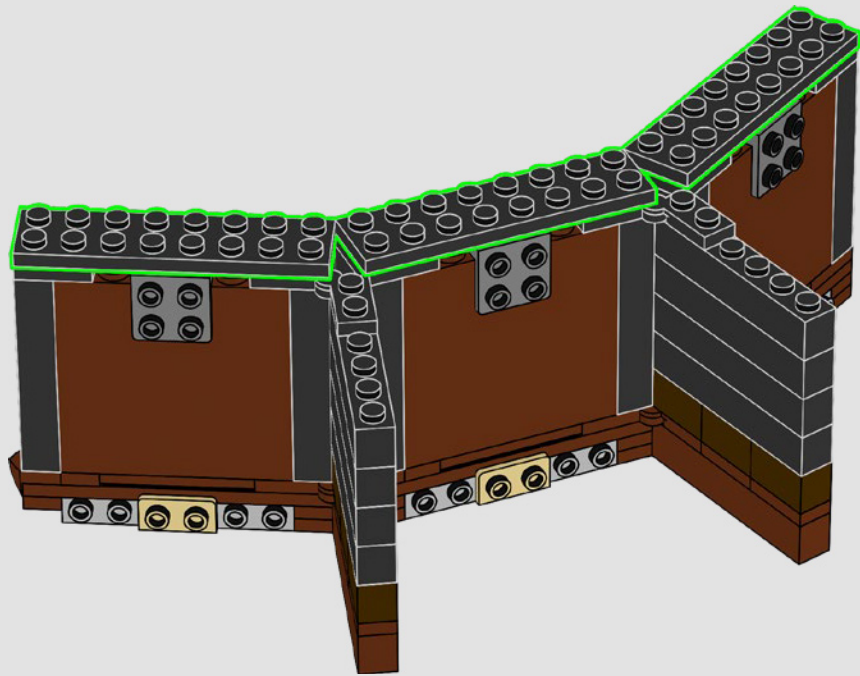

240

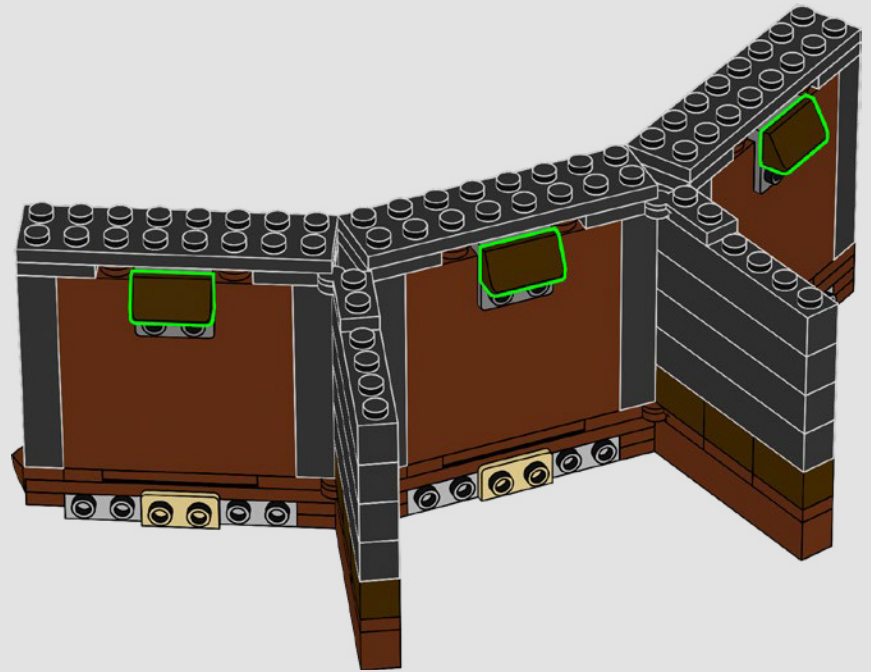



241

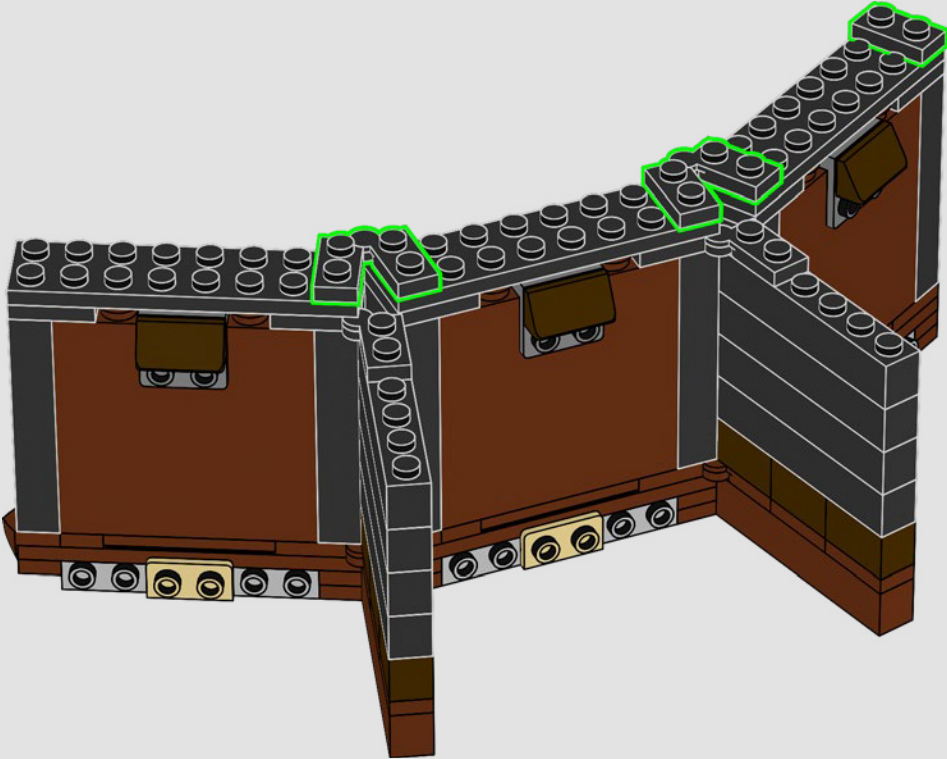



242

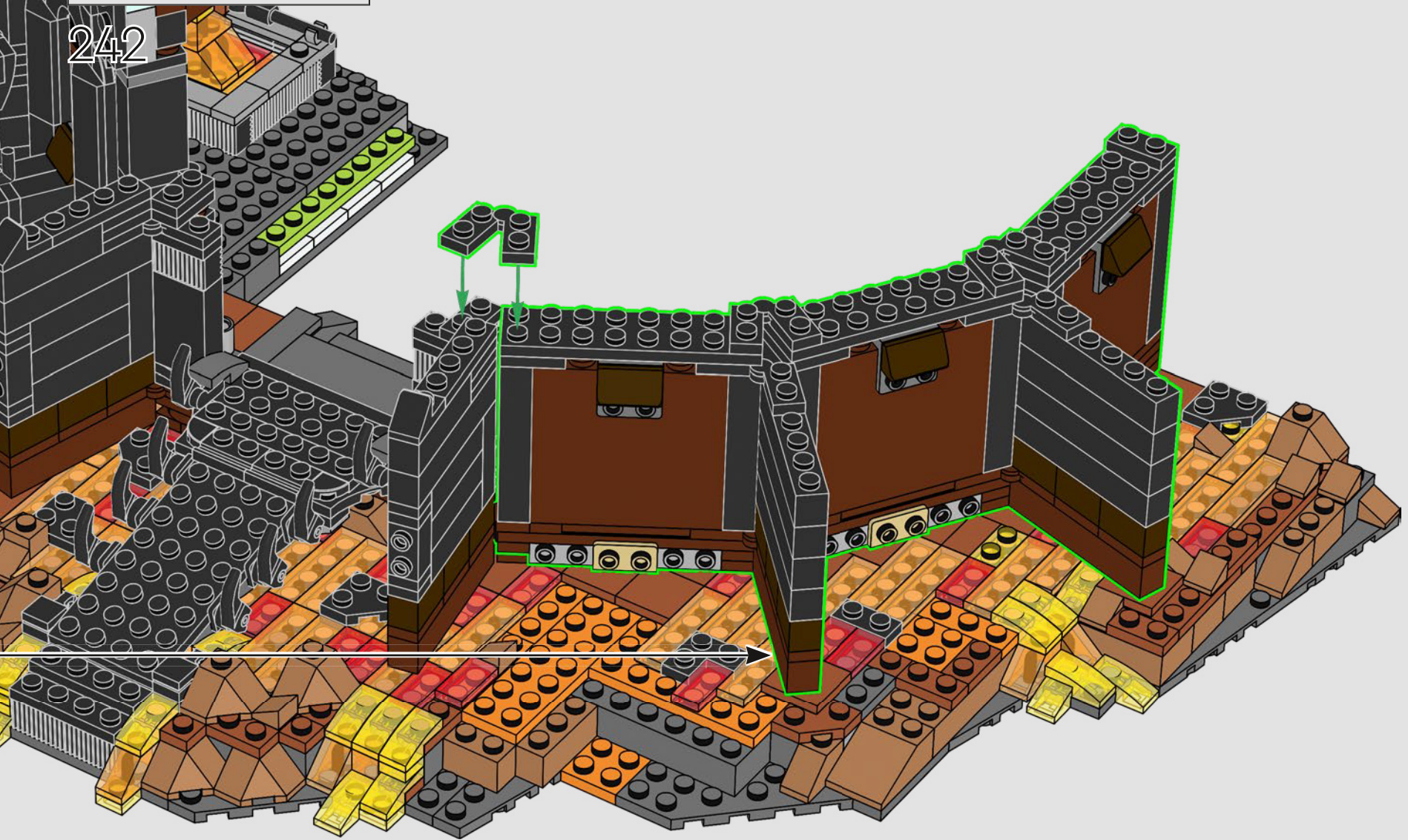

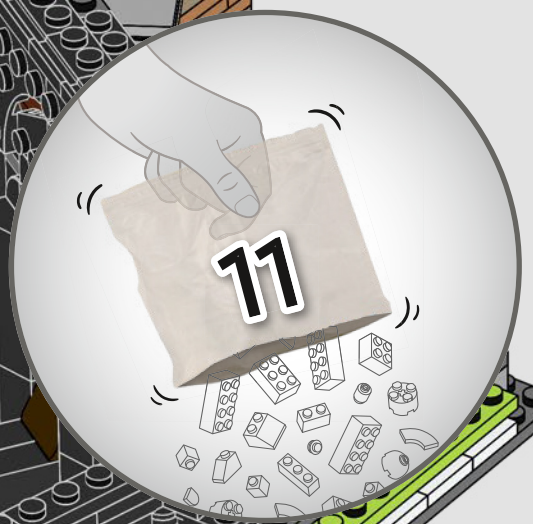

1x	2x	1x
1x	1x	1x

243

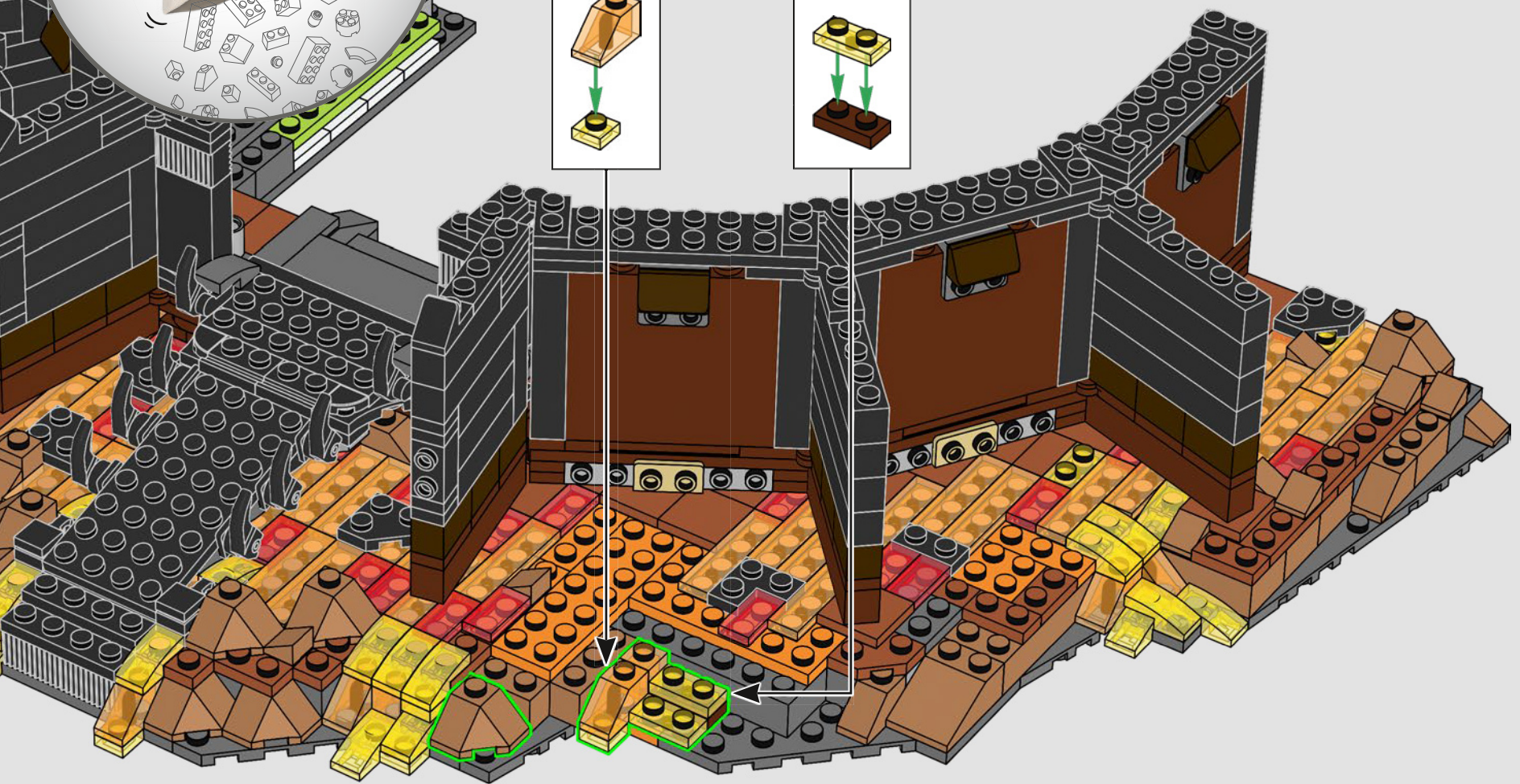
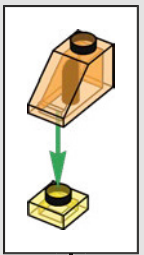

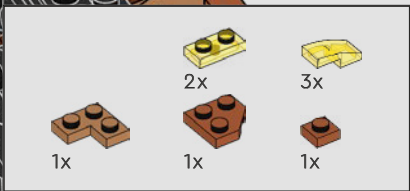

244

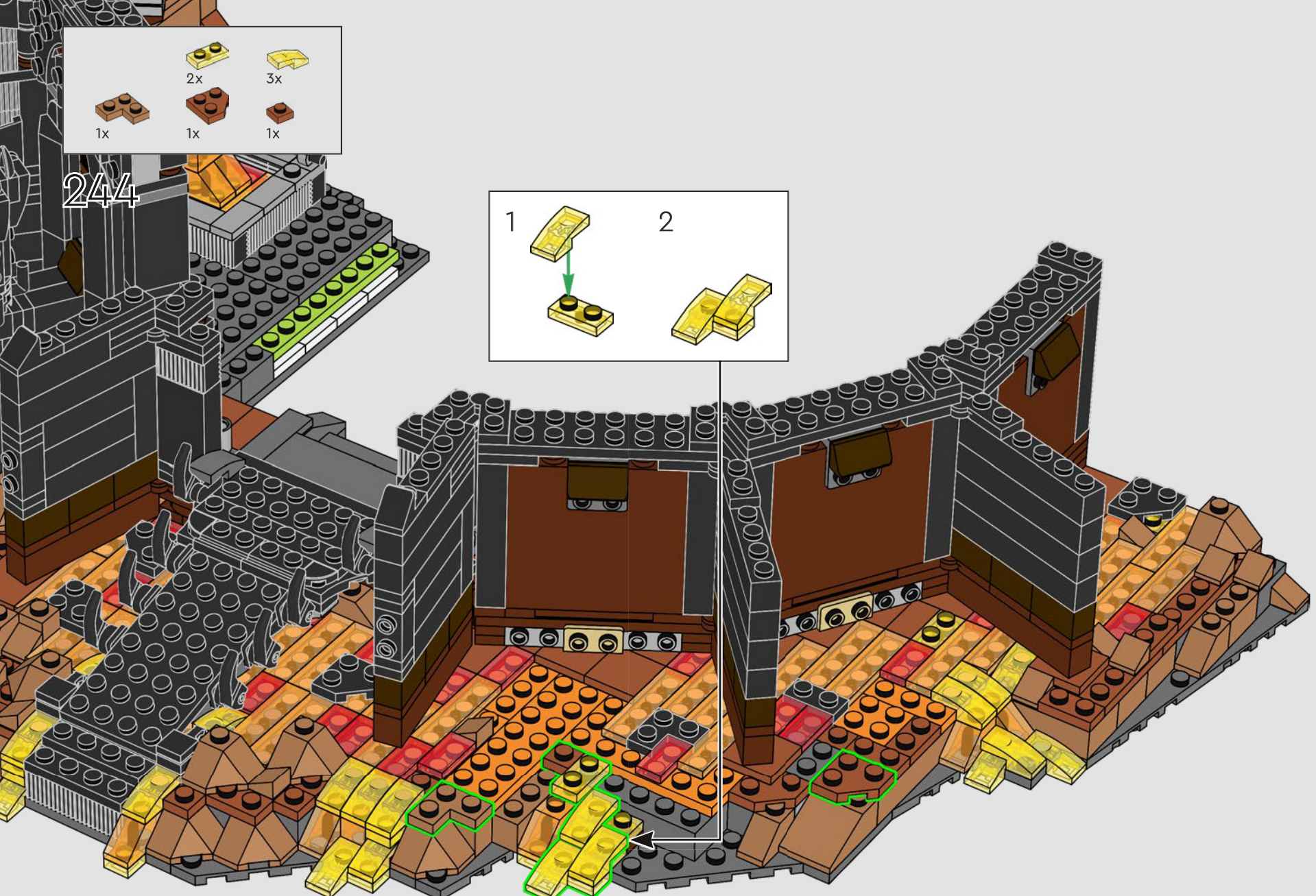
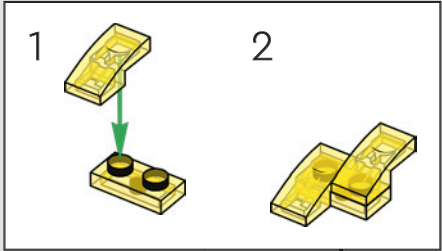

245

- 1x [Black 1x2 Technic Brick]
- 1x [Brown 1x2 Technic Brick]
- 4x [Yellow 1x2 Technic Brick]
- 2x [Brown 1x2 Technic Brick]
- 2x [Brown 1x2 Technic Brick]
- 4x [Orange 1x2 Technic Brick]
- 2x [Red 1x2 Technic Brick]
- 1x [Brown 1x2 Technic Brick]
- 2x [Brown 1x2 Technic Brick]
- 1x [Brown 1x2 Technic Brick]
- 1x [Brown 1x2 Technic Brick]

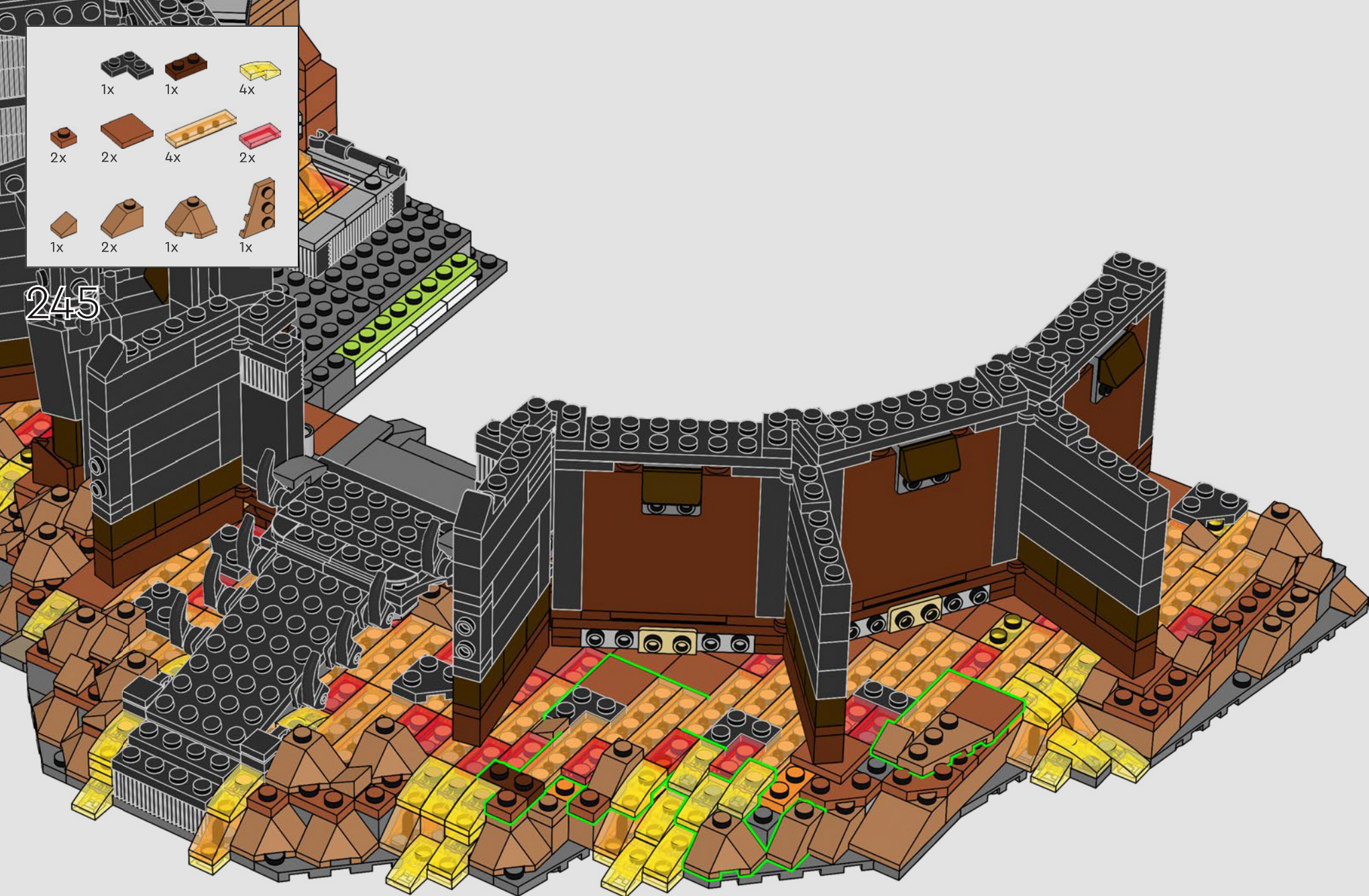



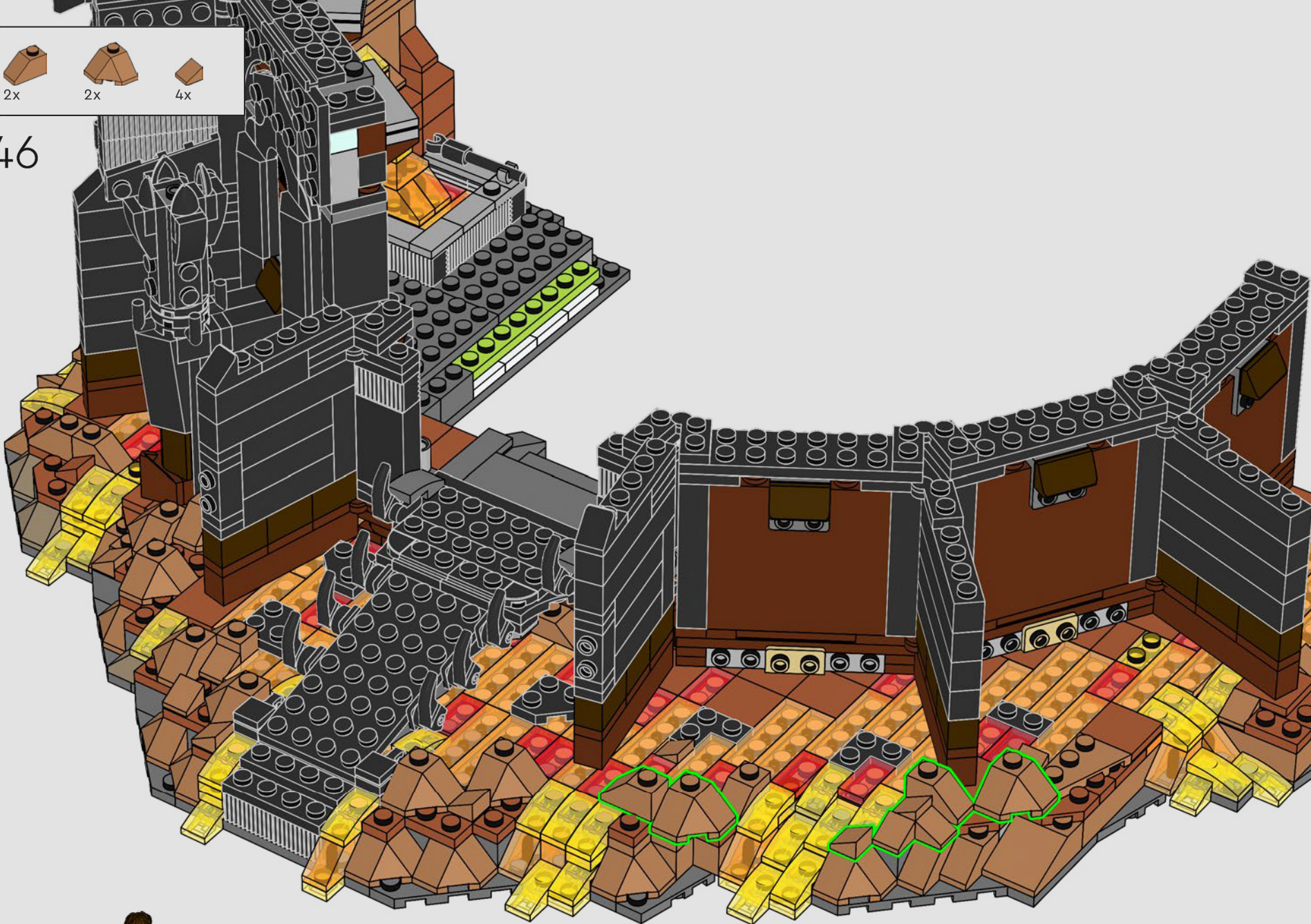

246

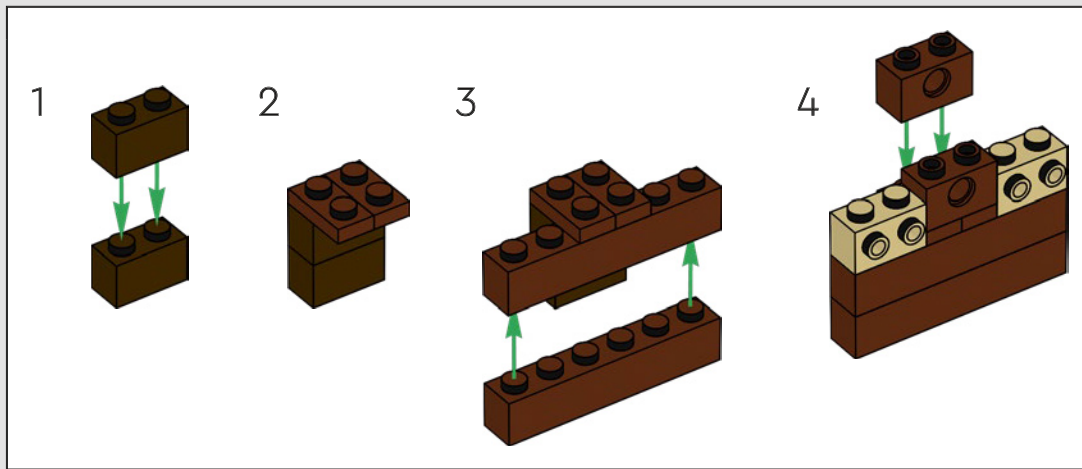
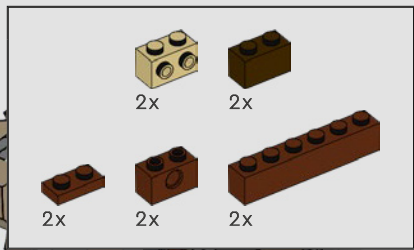

247



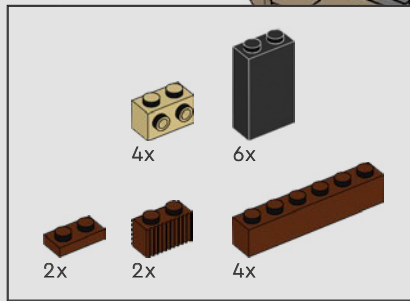

In der Elbensprache Sindarin bedeutet
Barad-dûr™ so viel wie „Dunkler Turm“.

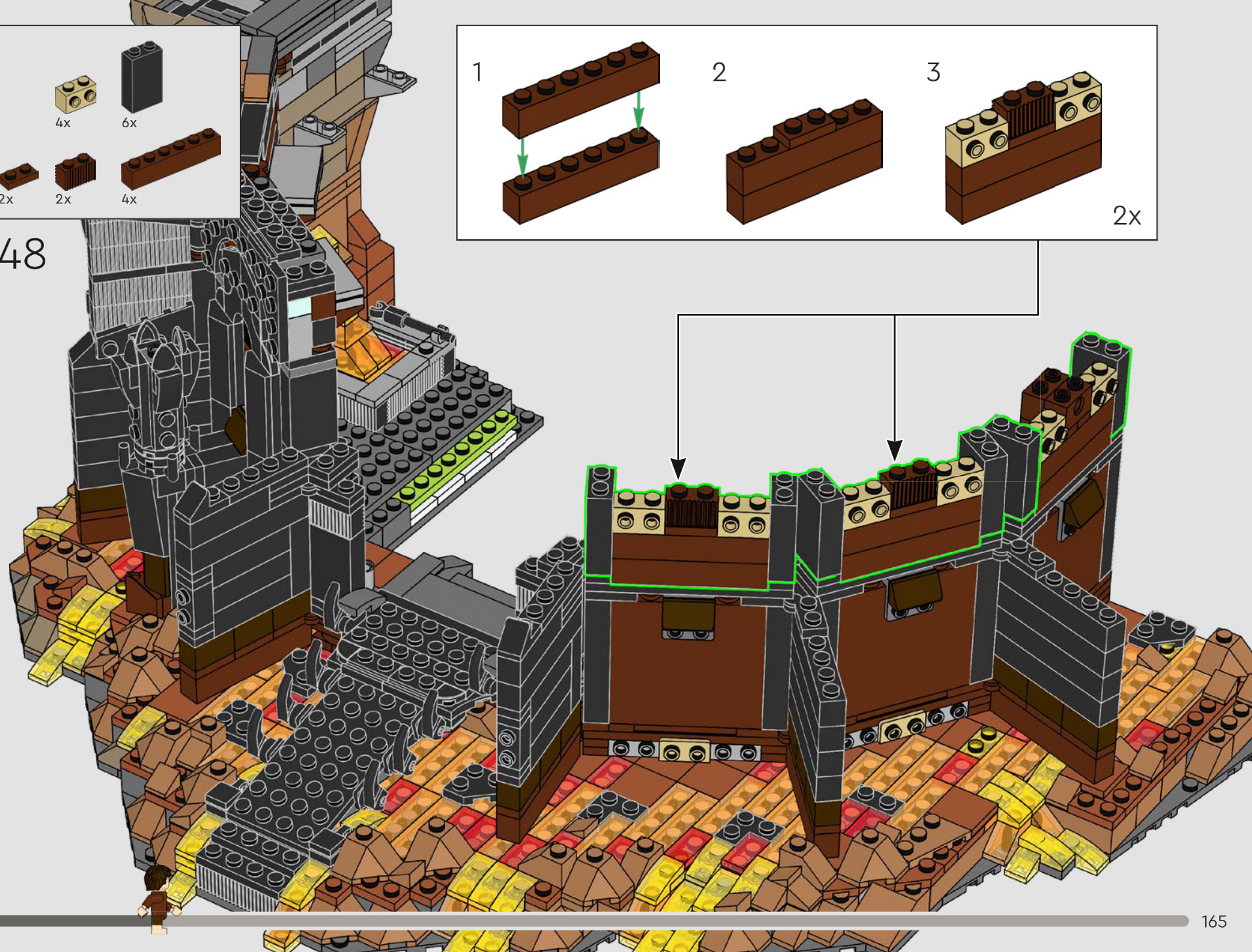
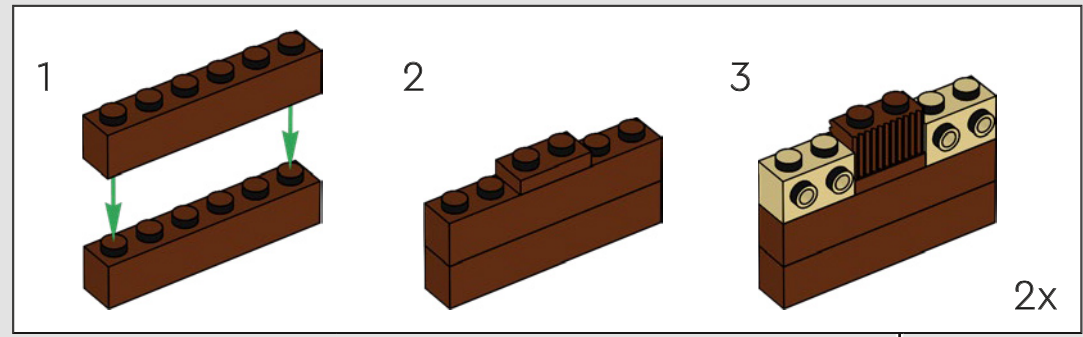

248

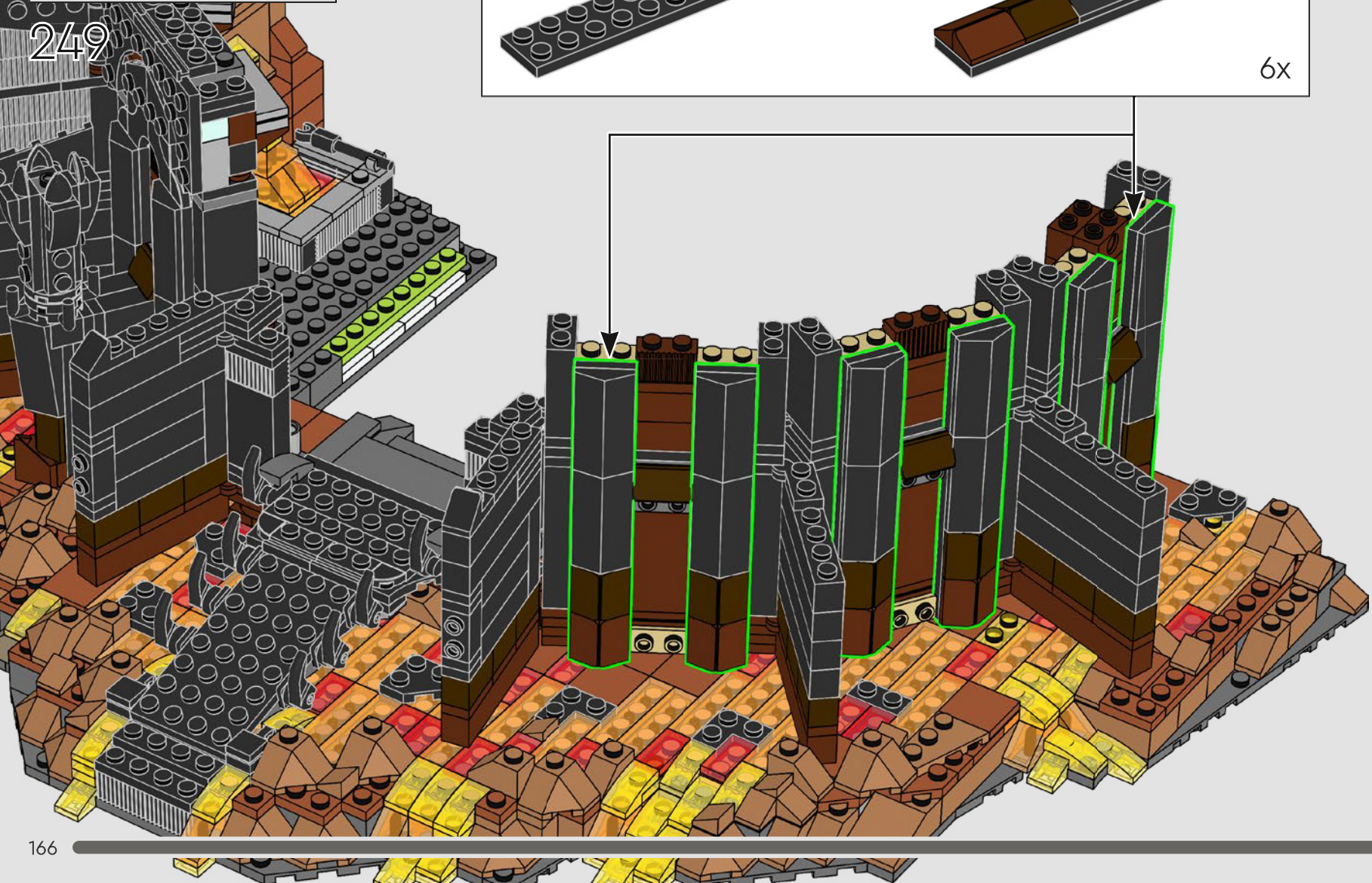
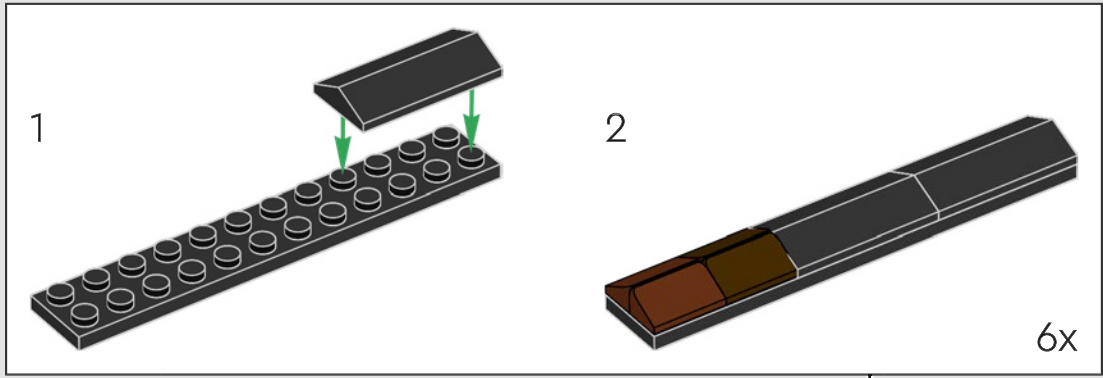
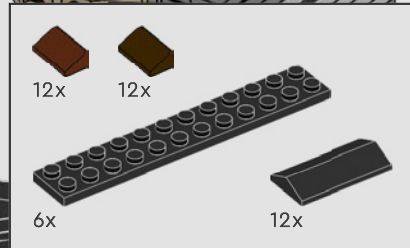

249



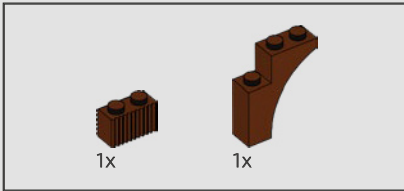
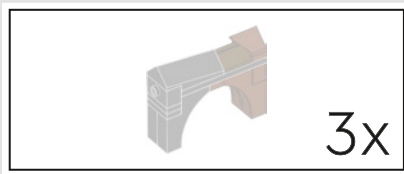

250

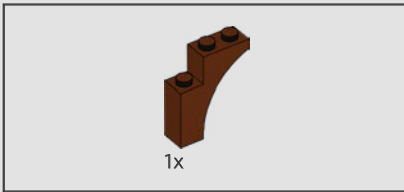
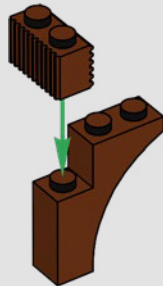

251

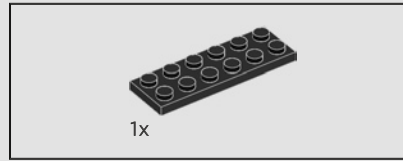
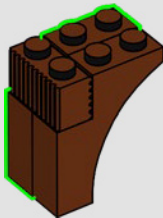

252

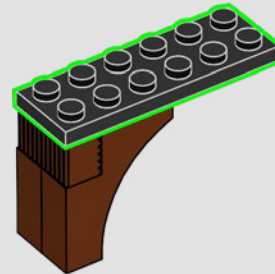

253

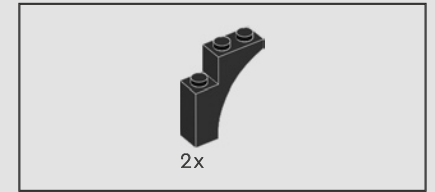
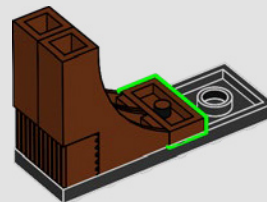

254

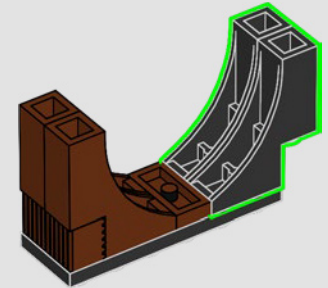



255

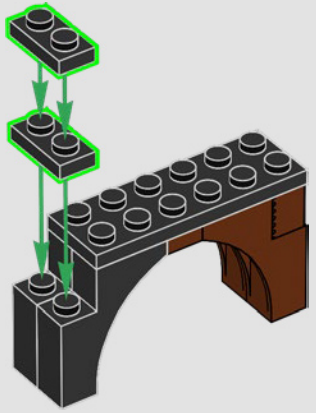

256

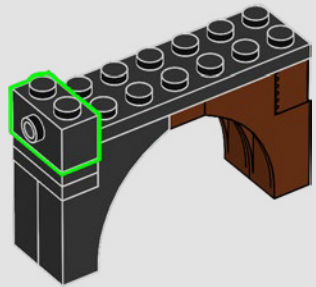

257

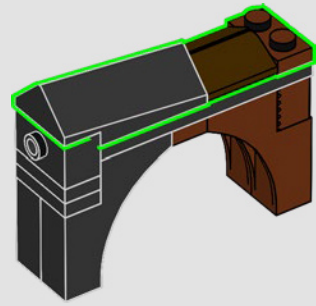

258

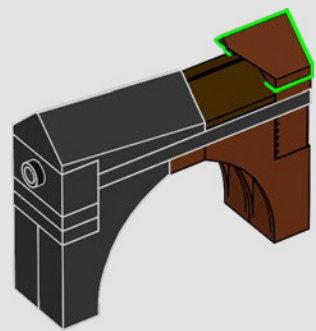

3x

259

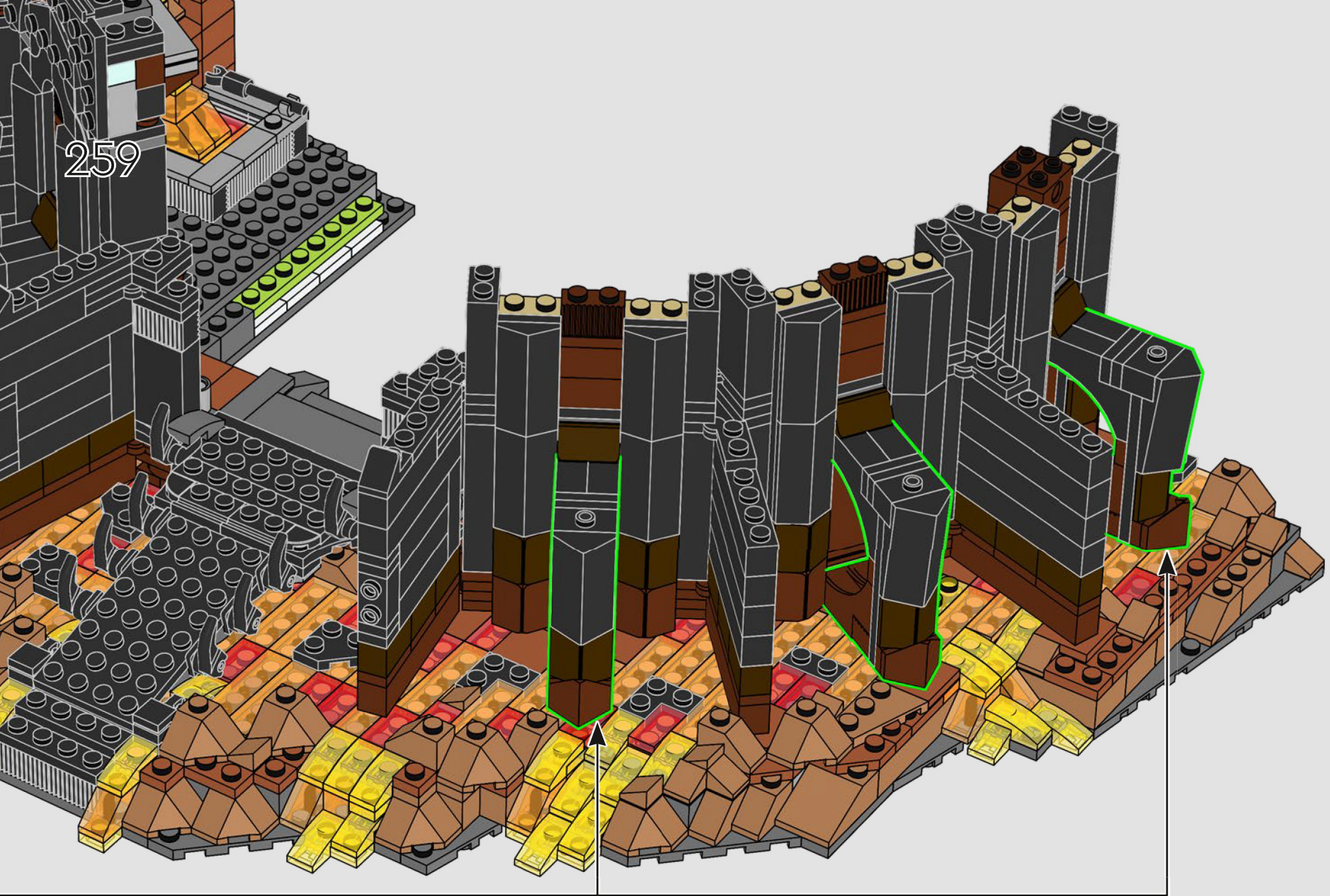

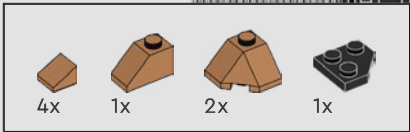

260

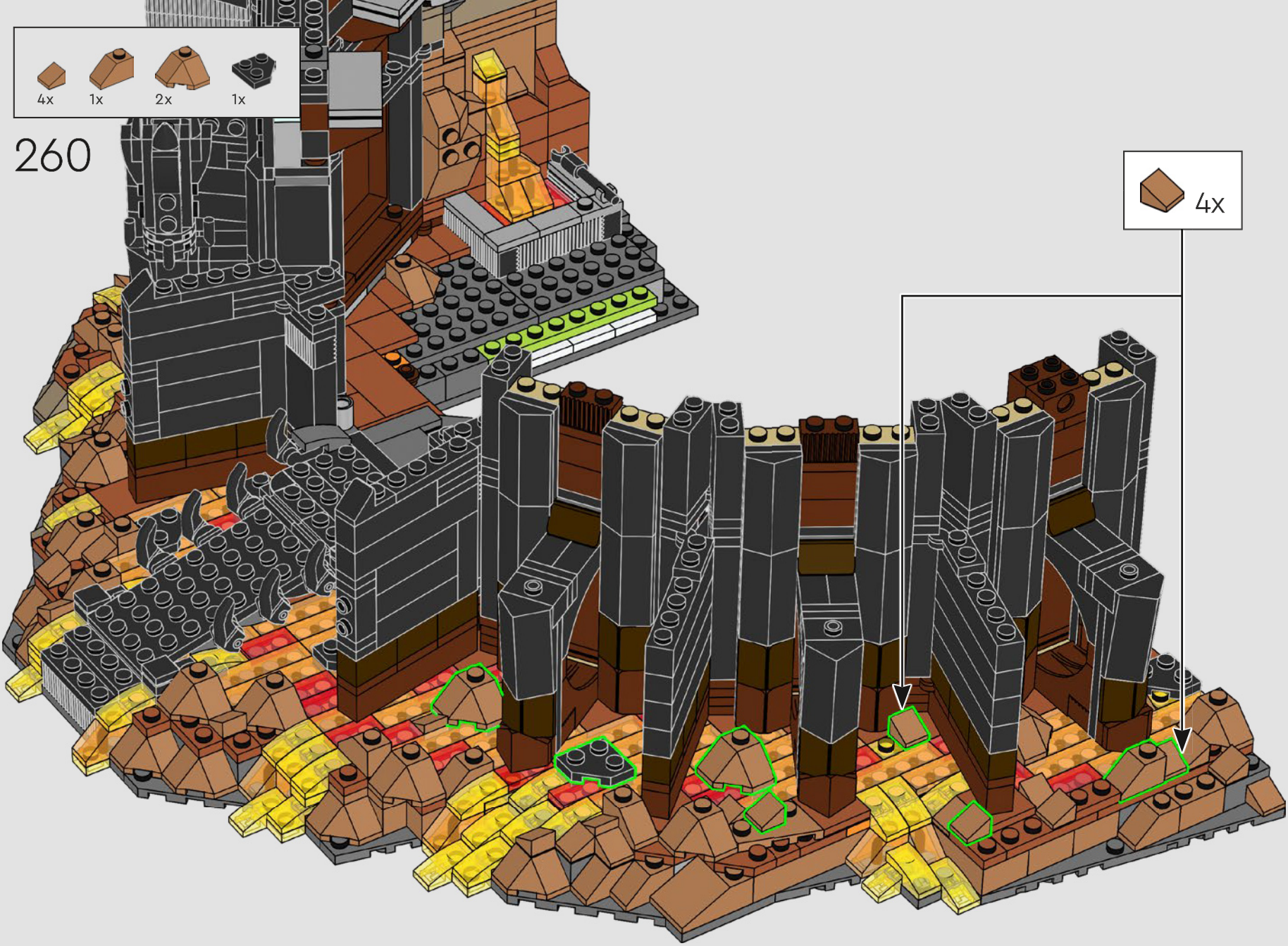

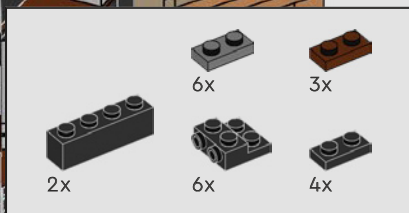
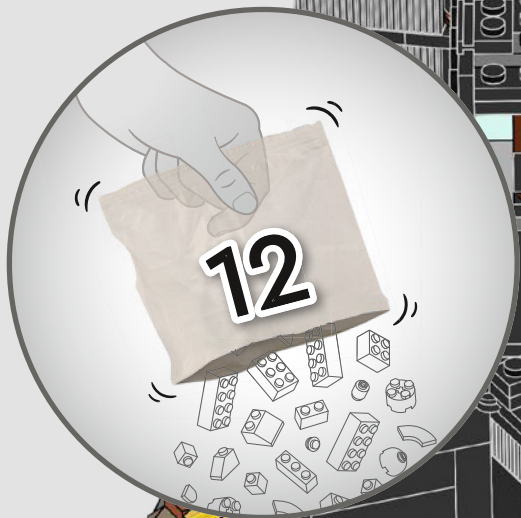

261

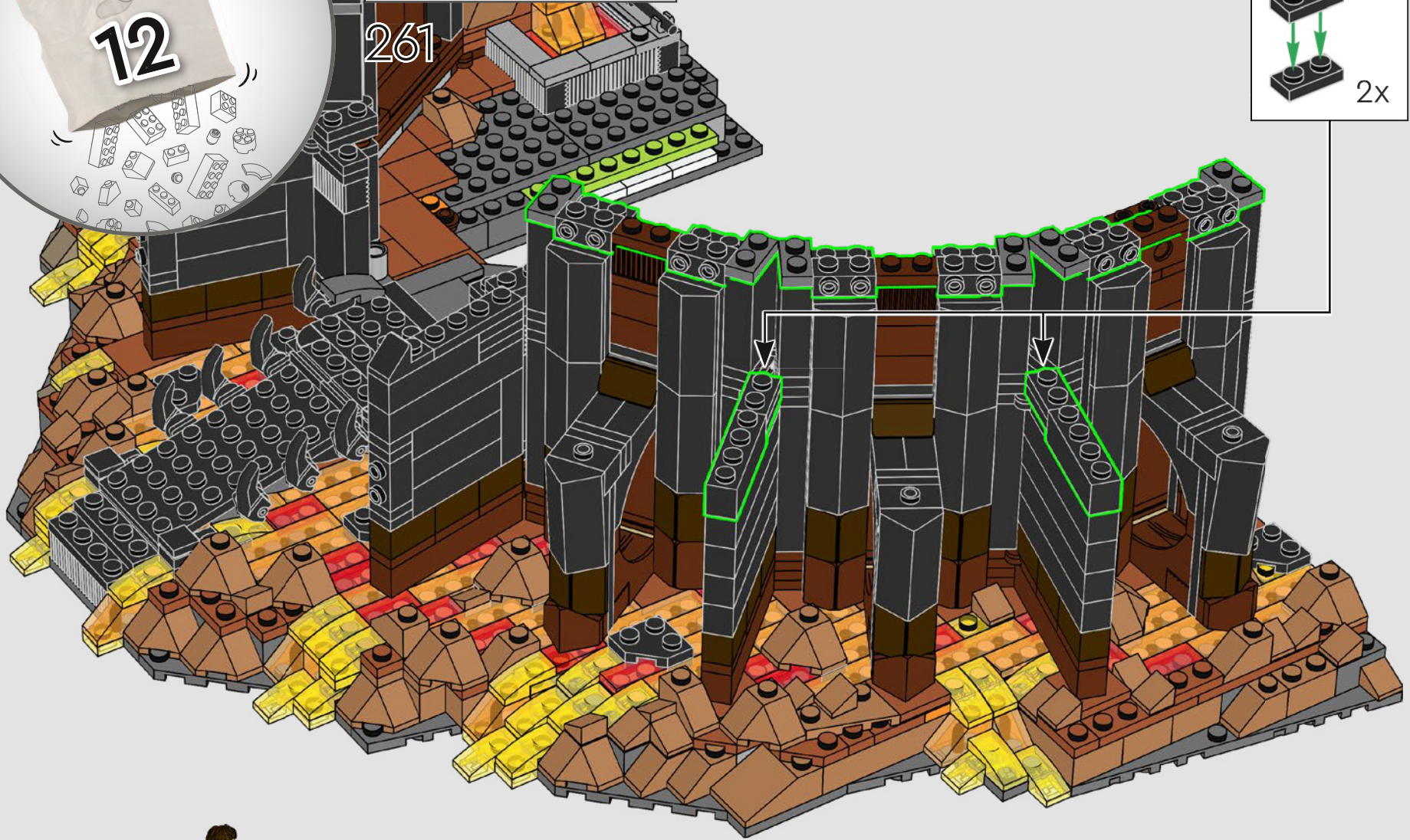
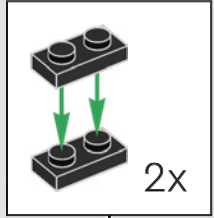

2x 4x 3x

262

2x

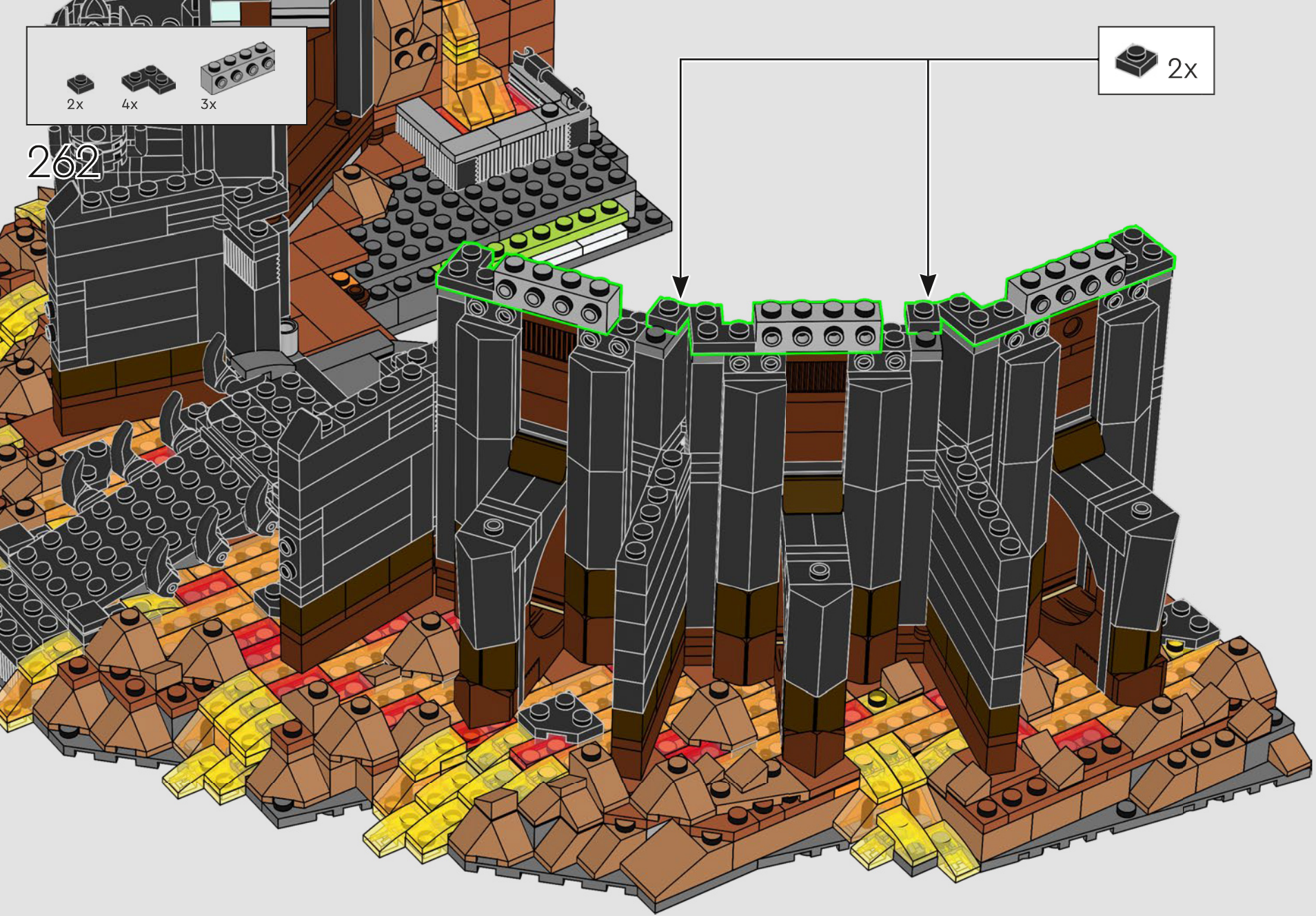

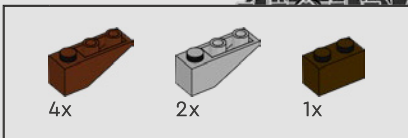

263

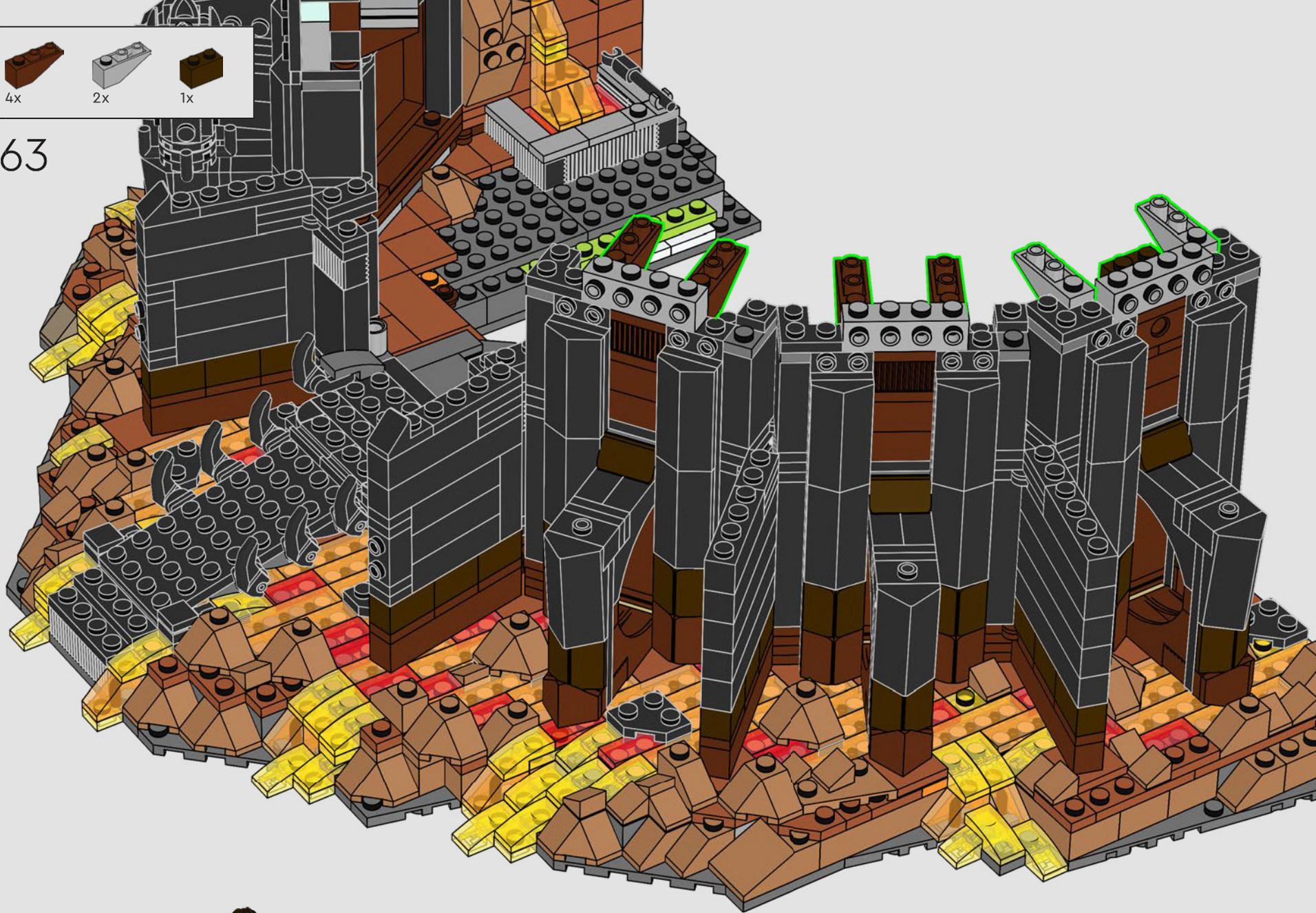

12x  6x 

264



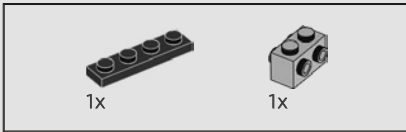
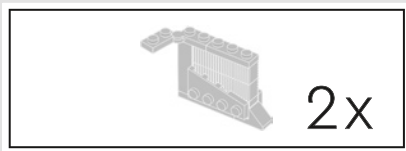

265

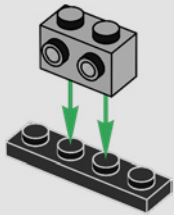

266

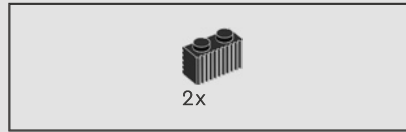
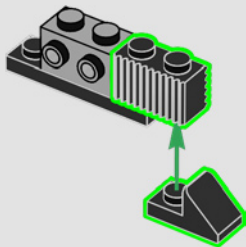

267

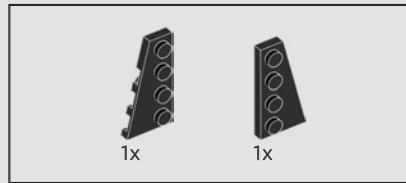
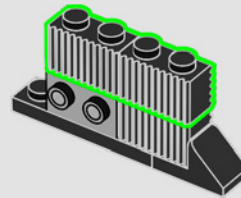

268

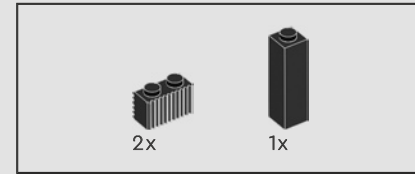
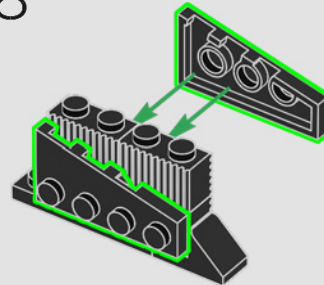

269

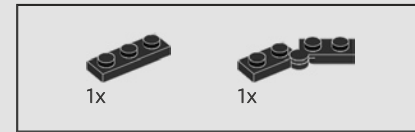
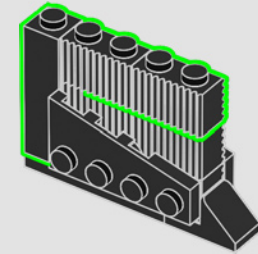

270

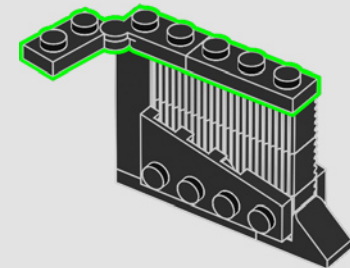

2x

Barad-dûr™ ist angeblich mehr als 914 Meter hoch
und somit das höchste Bauwerk in Mittelerde.
Seine Bauzeit betrug 600 Jahre.

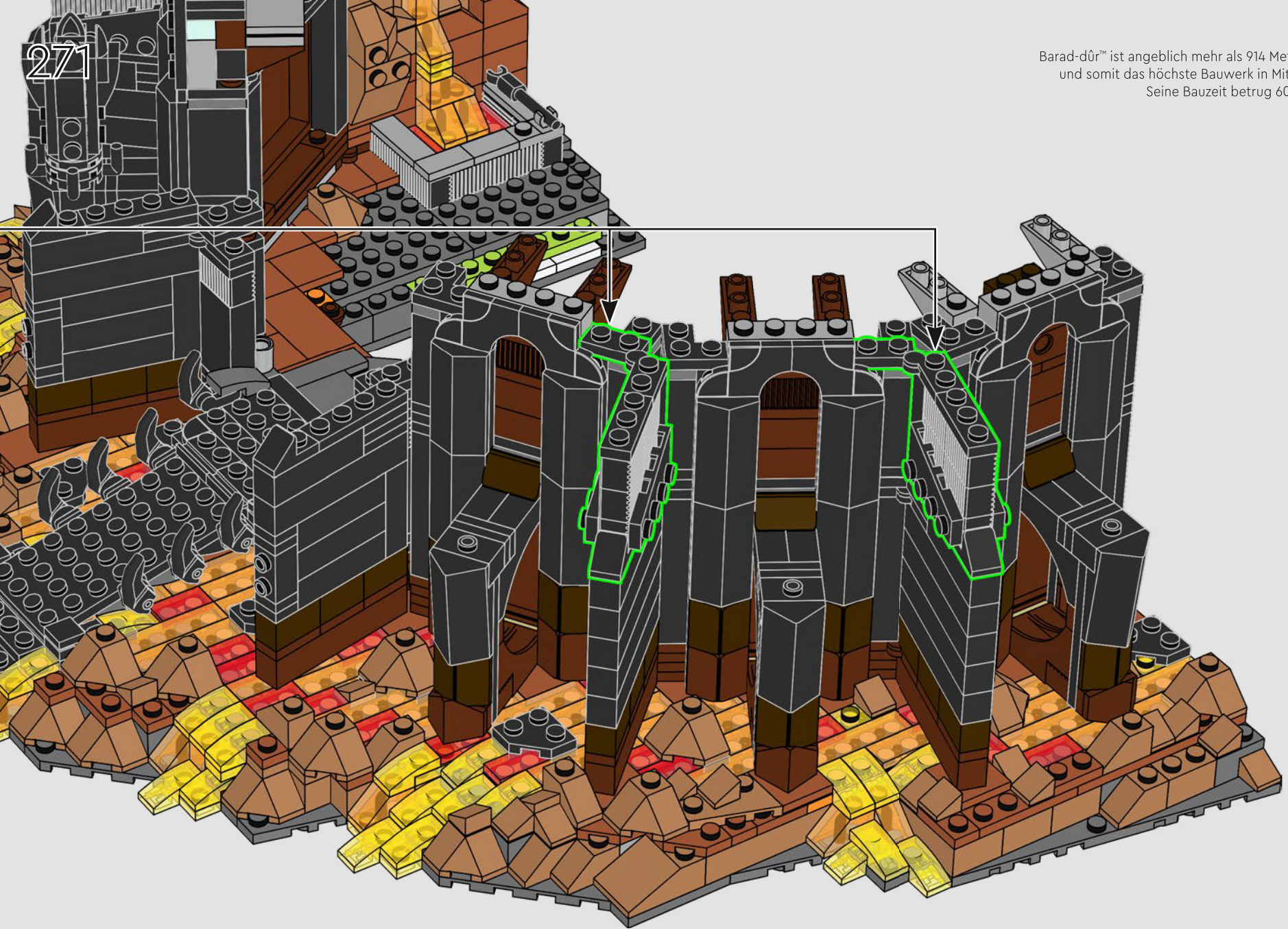

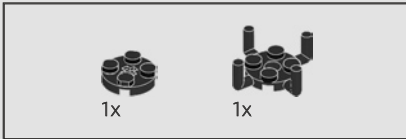
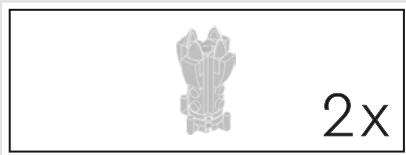

272

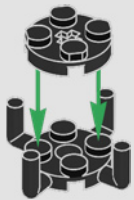

273

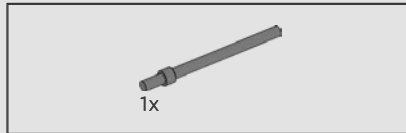

274

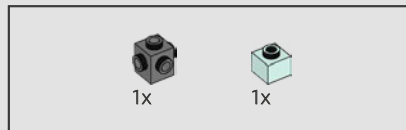
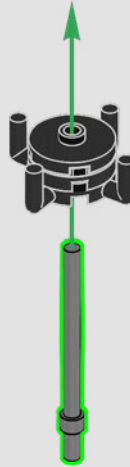

275

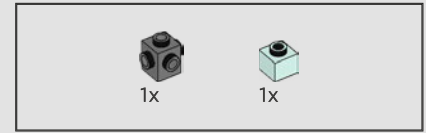
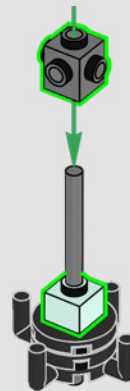

276

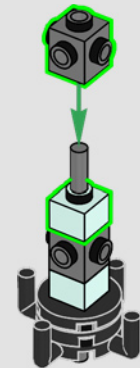

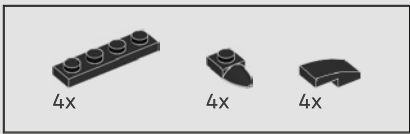

277

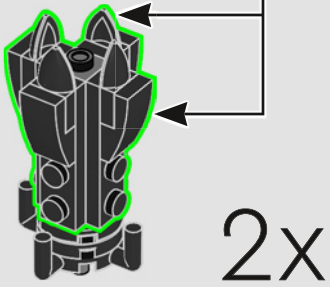
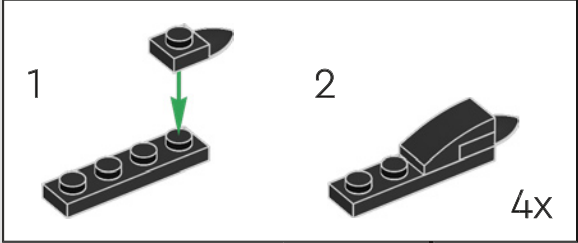

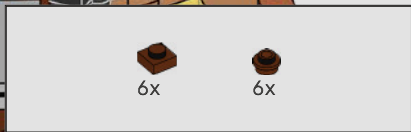

279

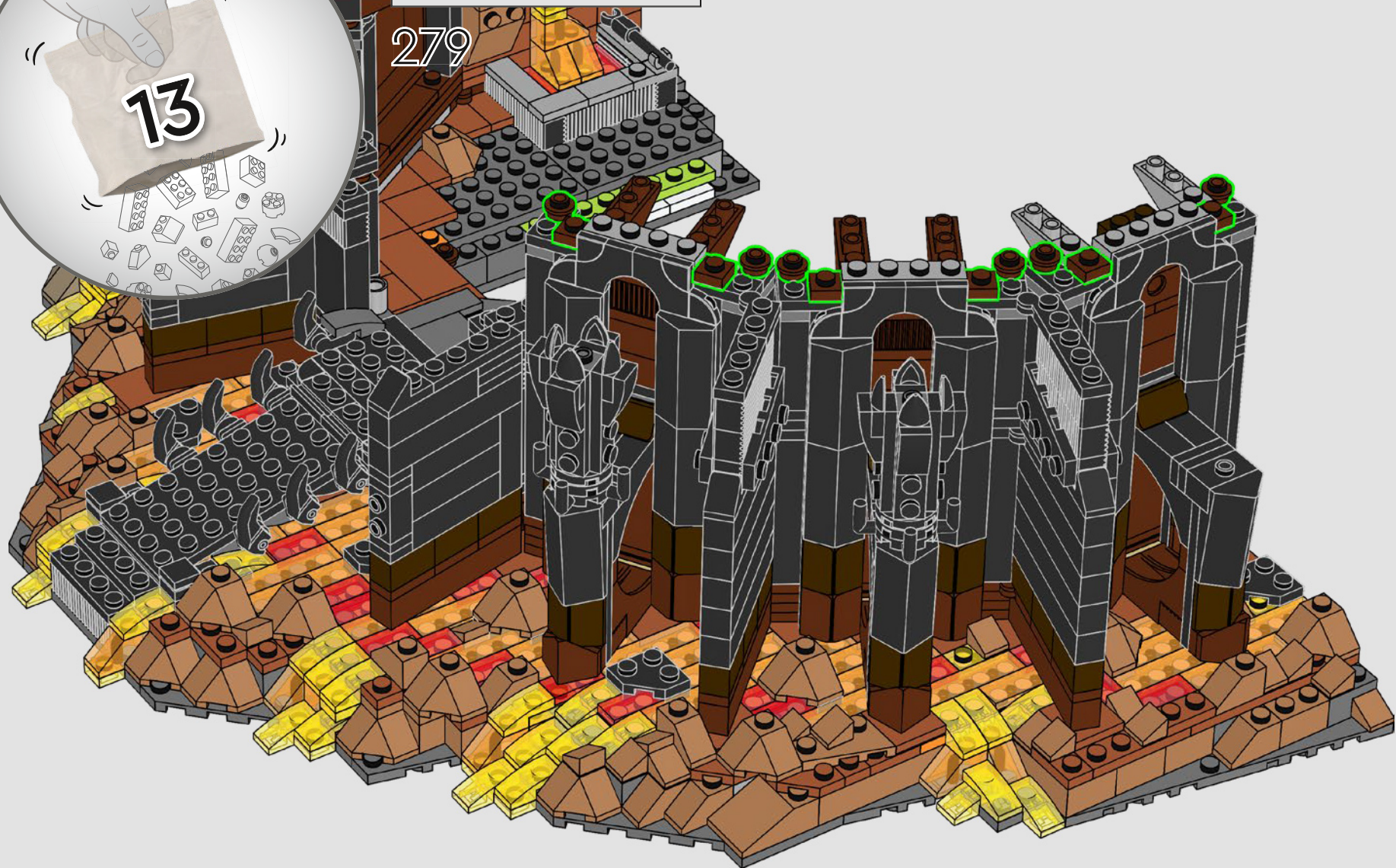

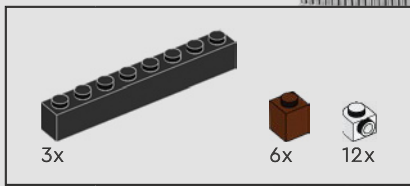

280

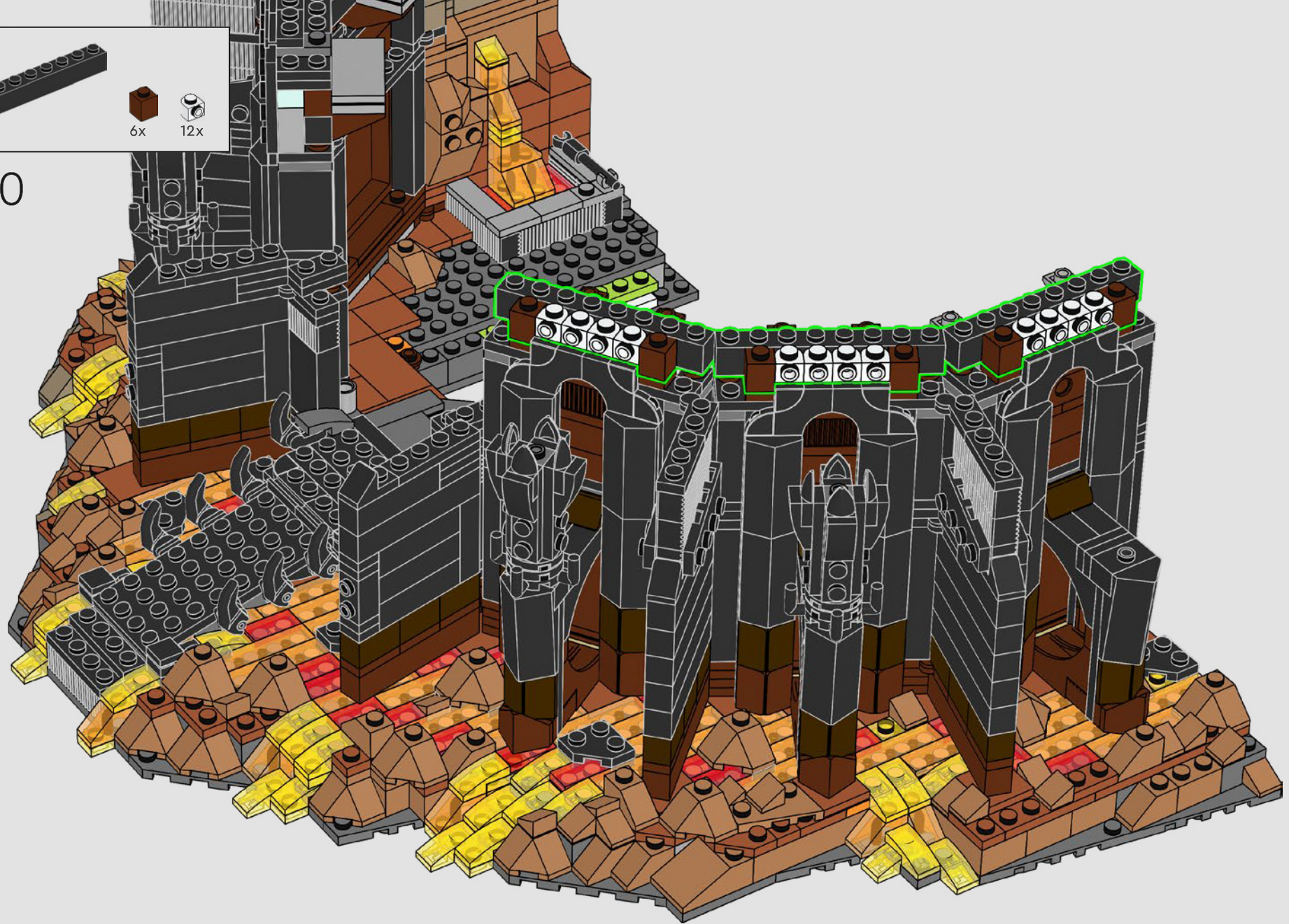

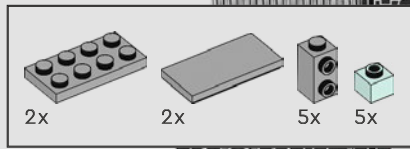

281

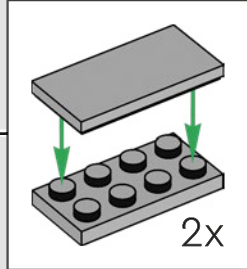
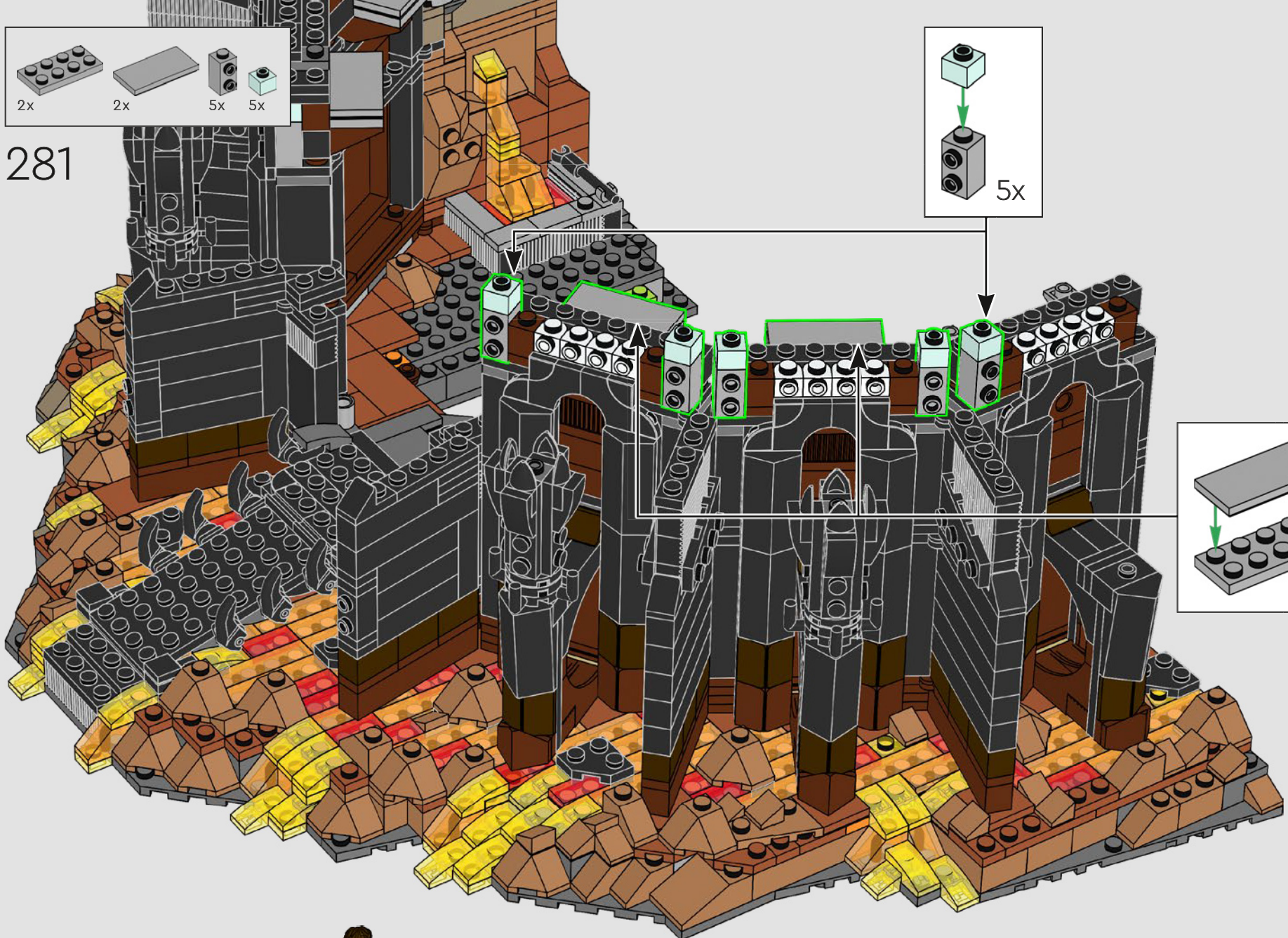
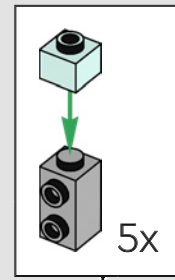

282

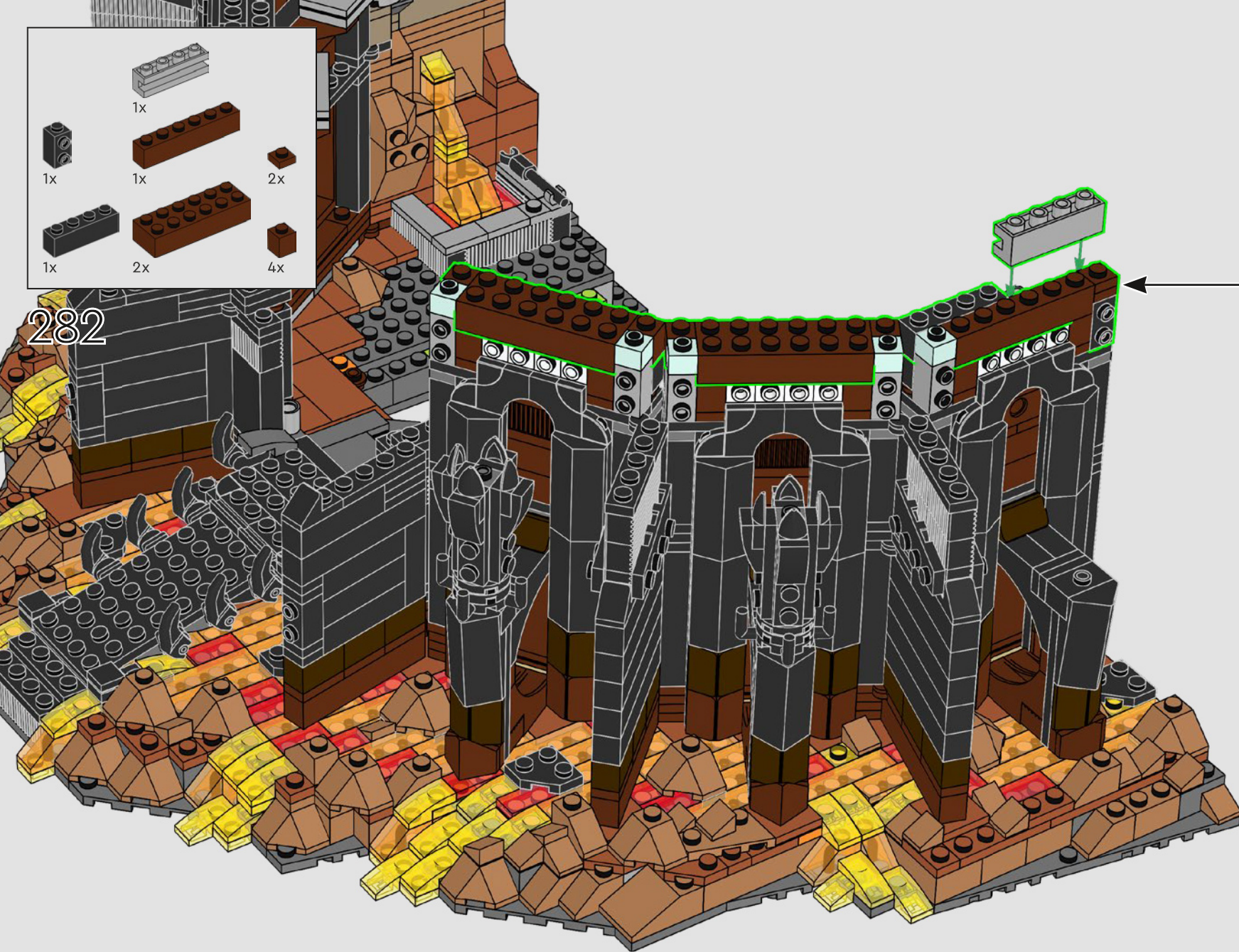
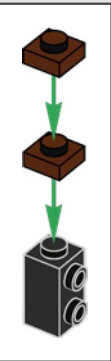
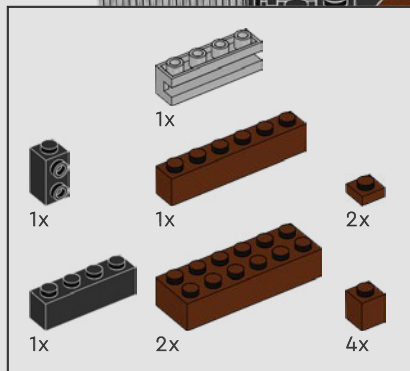

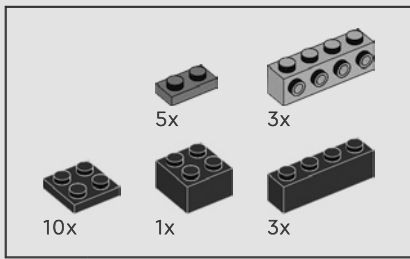

283

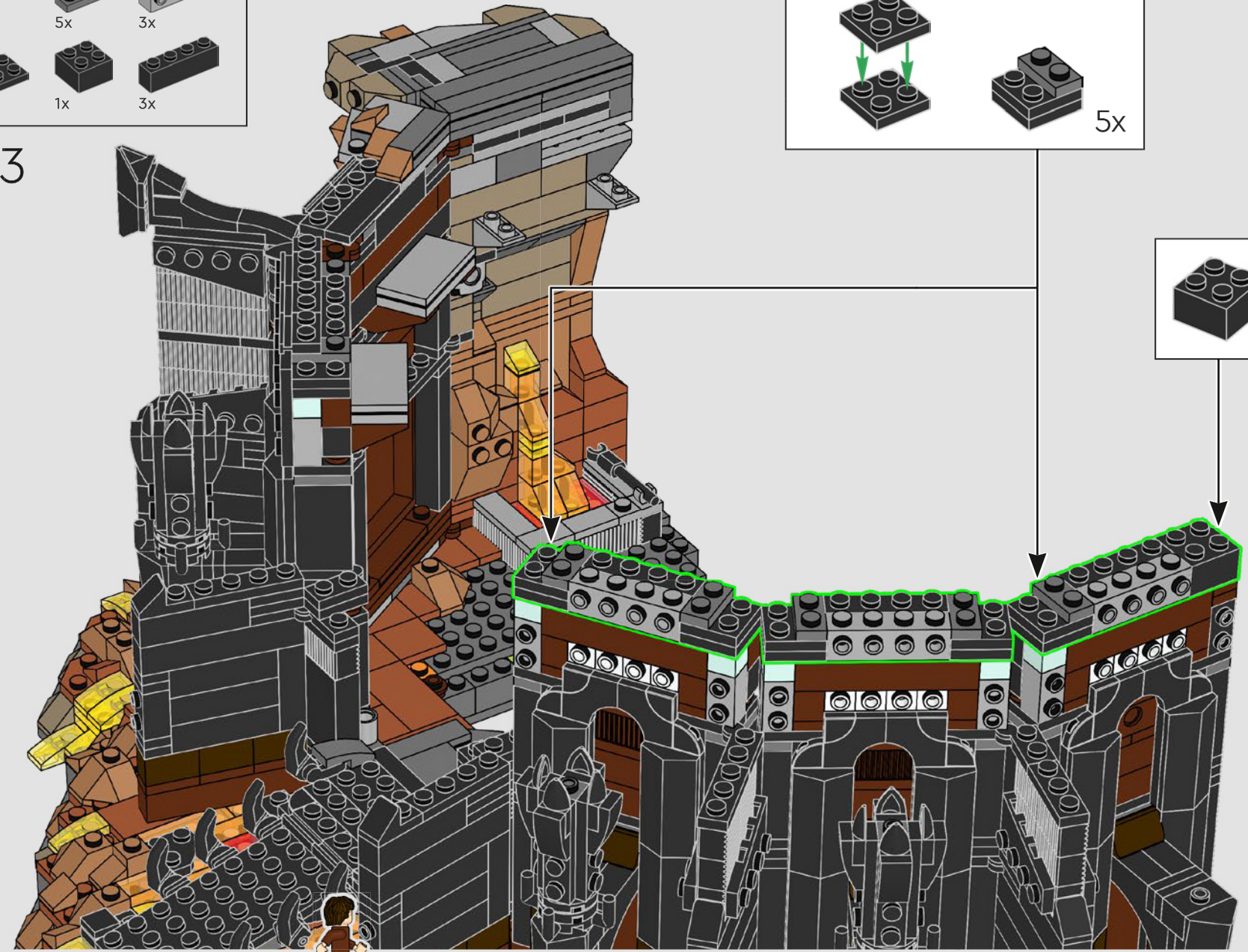
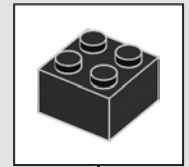
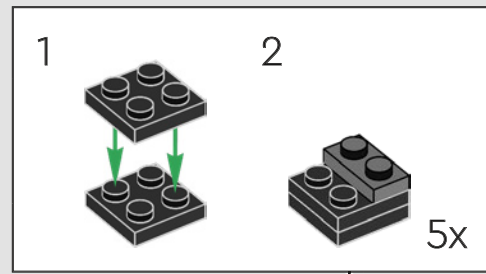

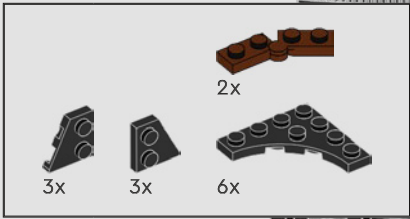

284

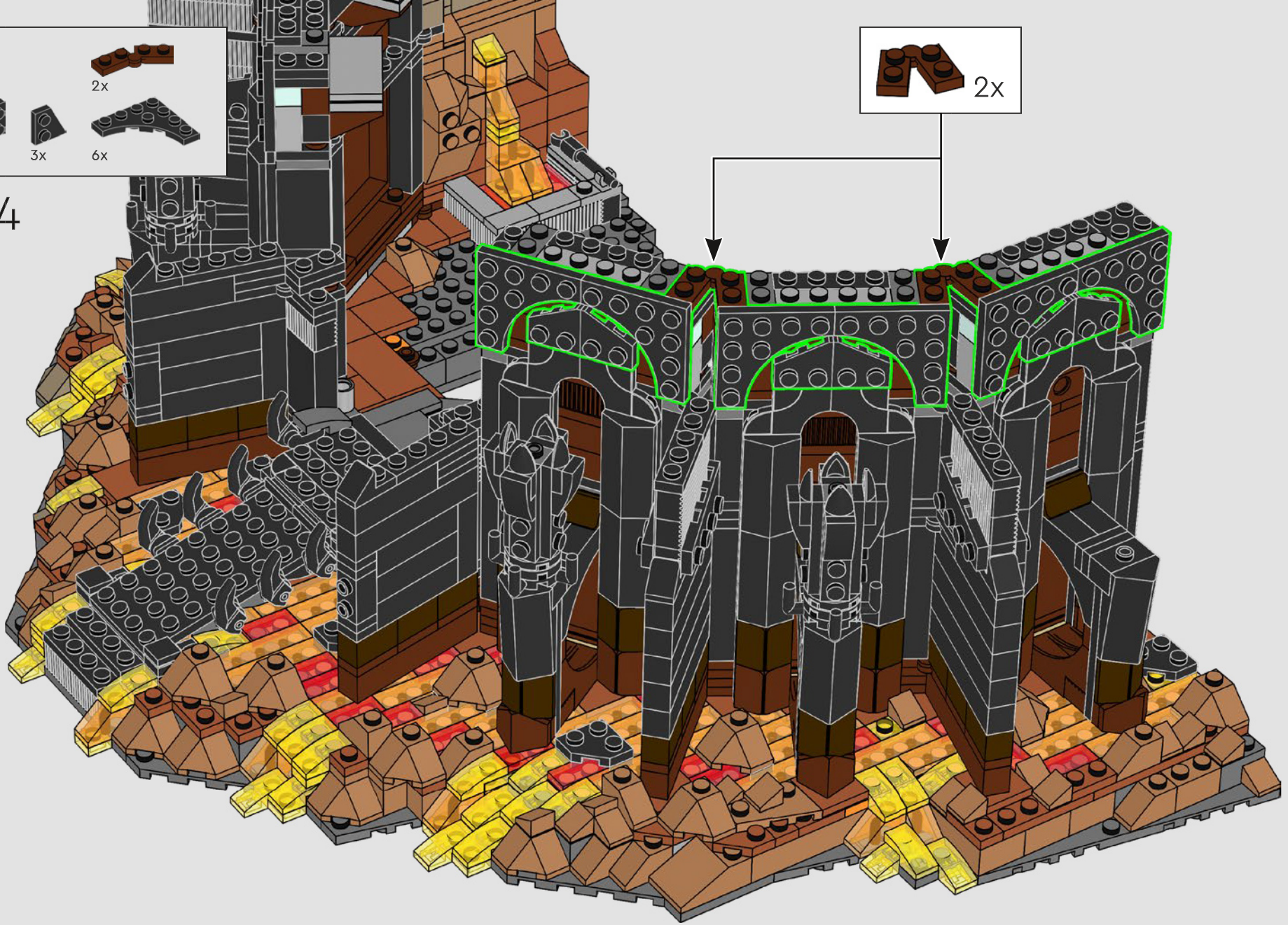

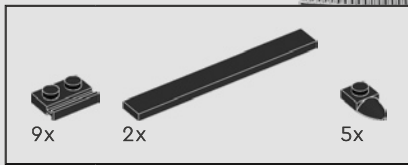



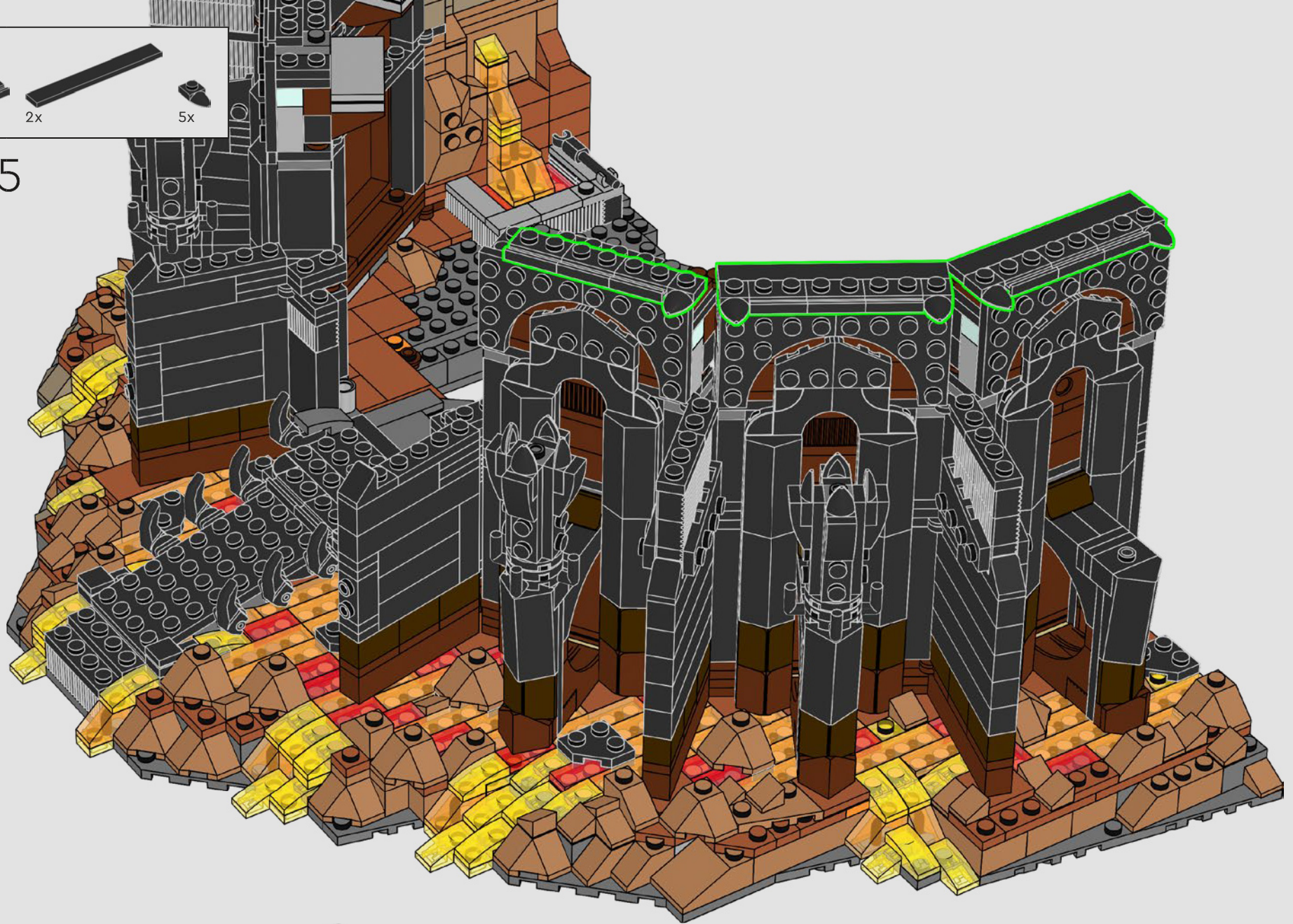

285



6x  2x 

286

1  
2    2x

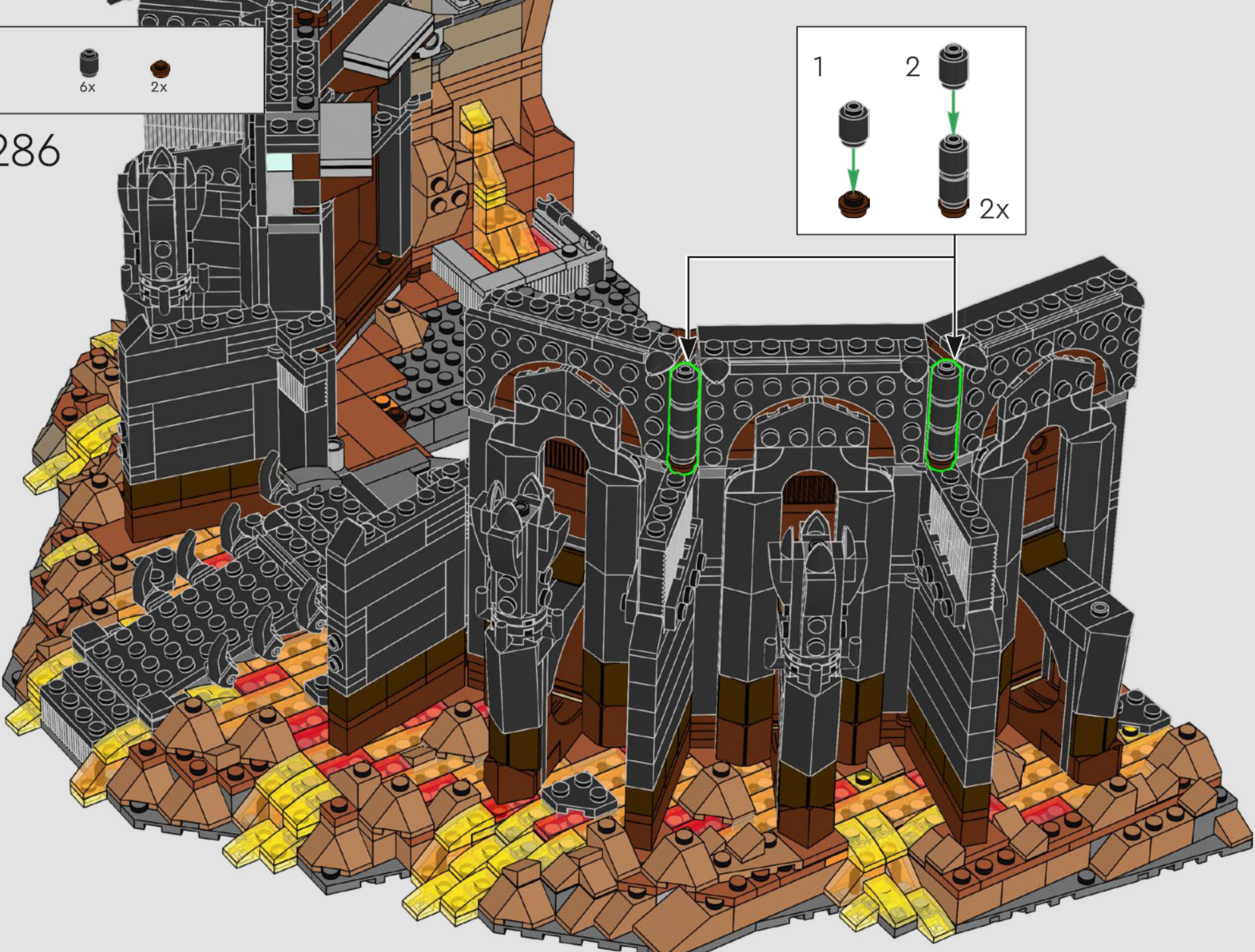



172 schwarze 1x2 Profilsteine wurden verwendet, um die strukturierten Turmmauern zu erschaffen.

- 10x
- 2x
- 4x

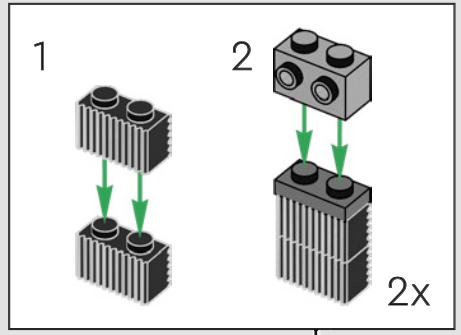

287

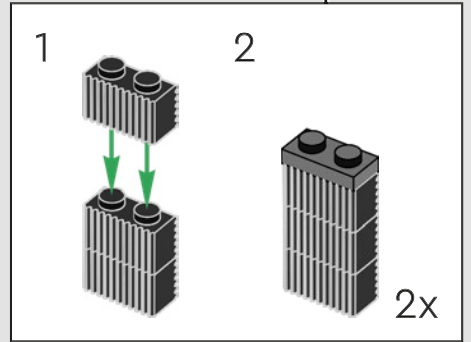

288

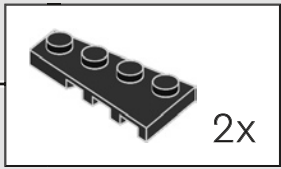
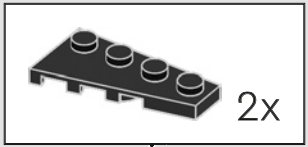

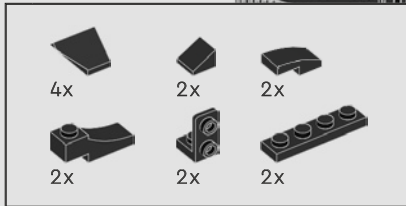

289

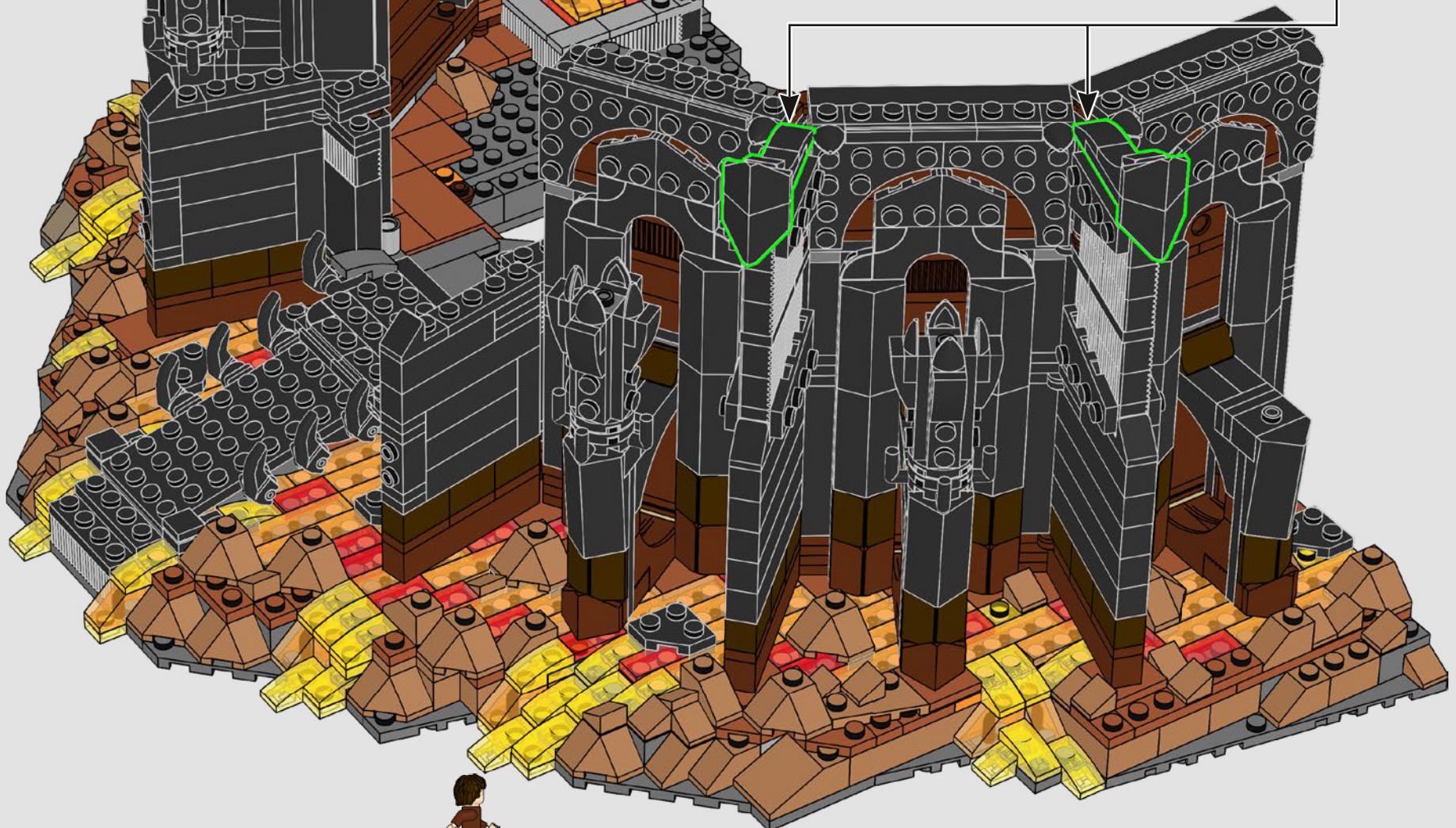
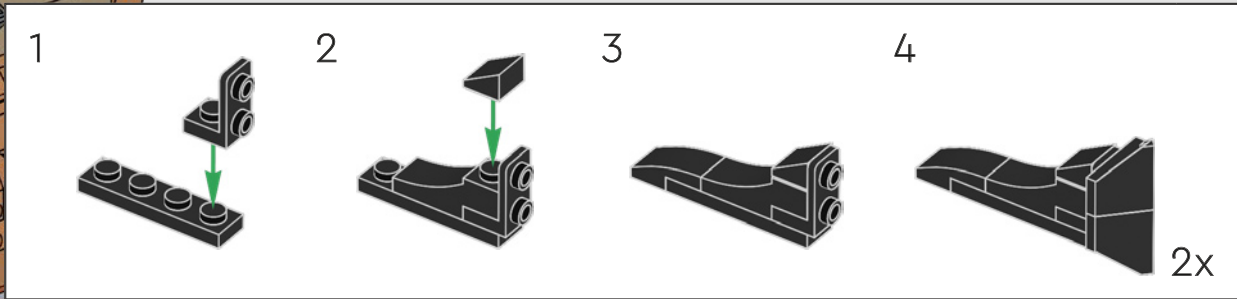

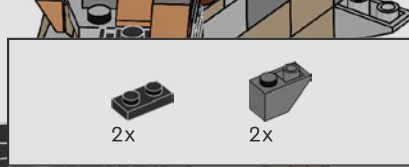
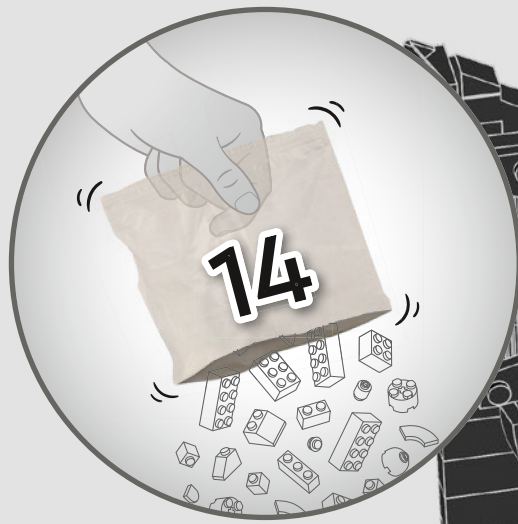

290

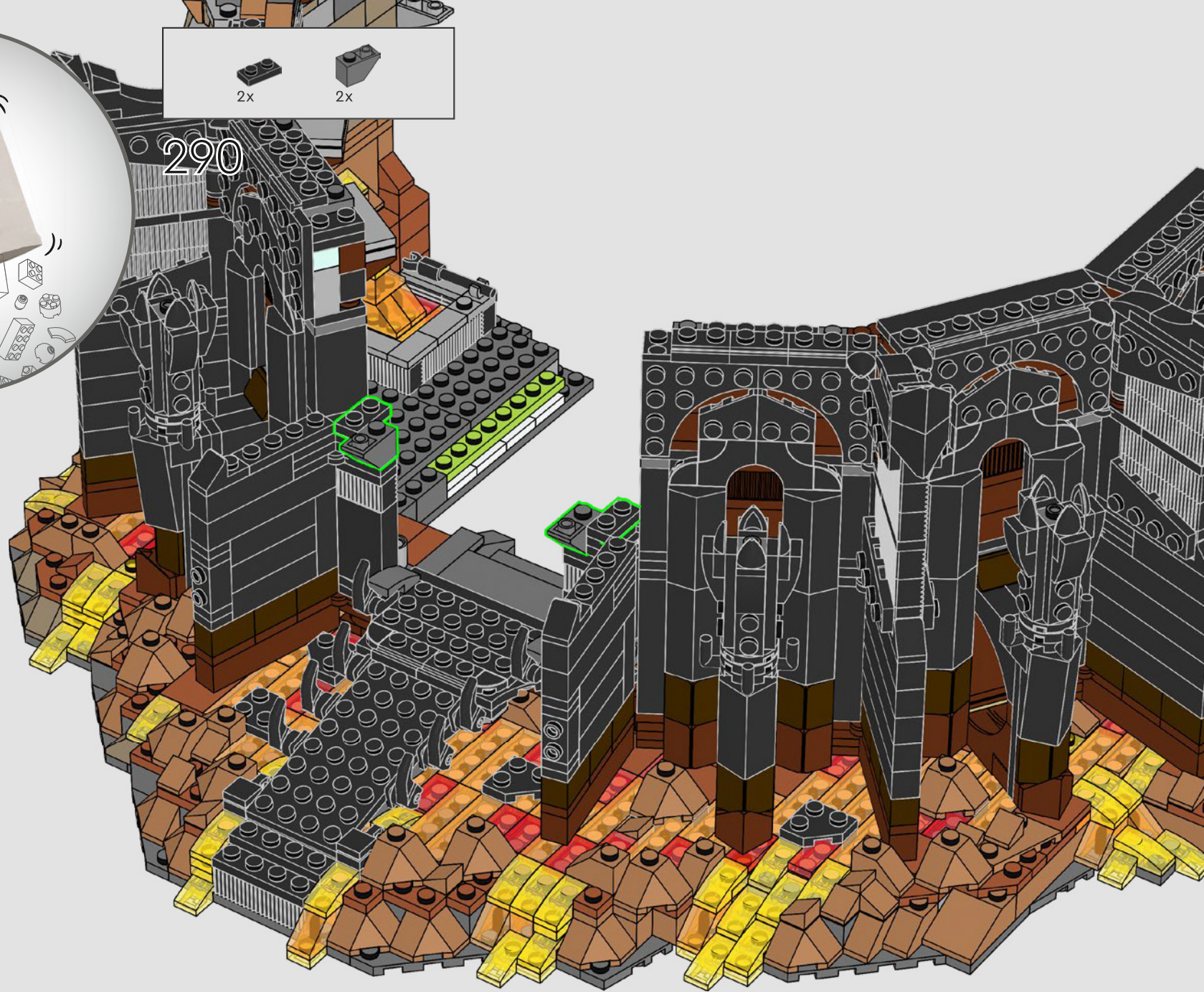

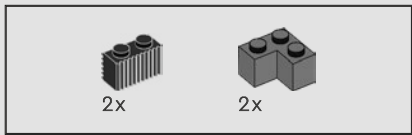

291

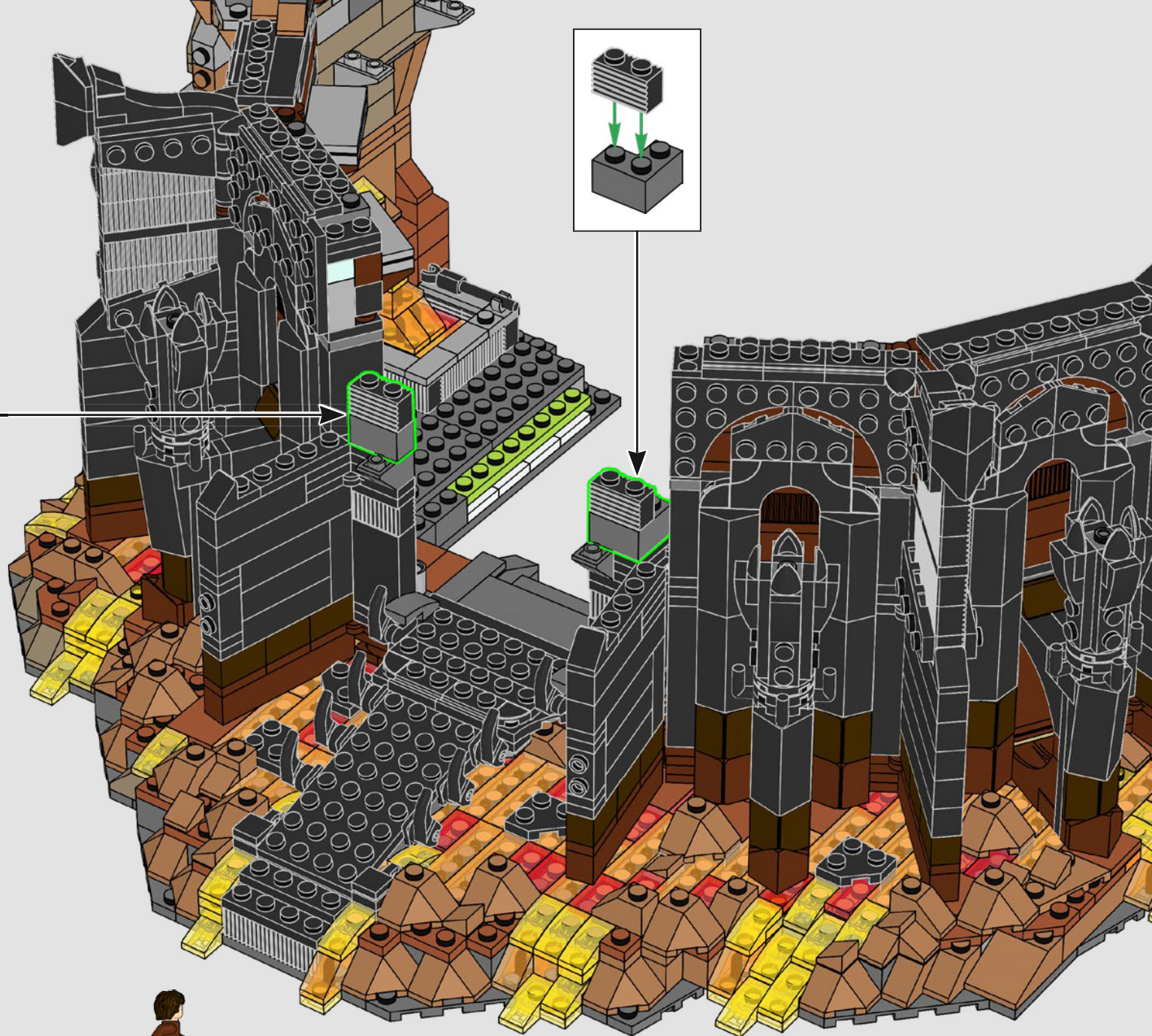
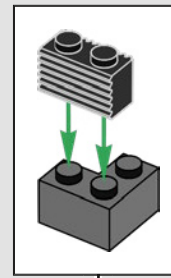
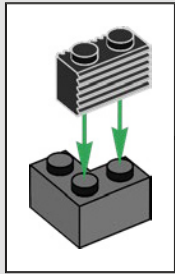

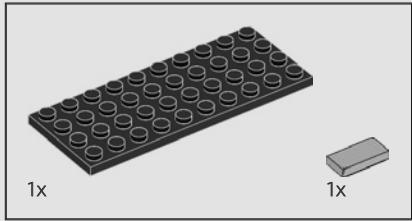
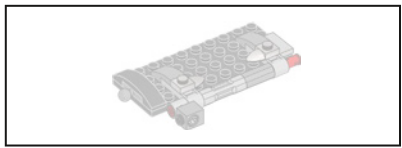

292

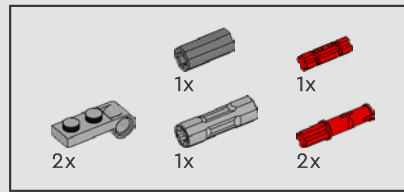
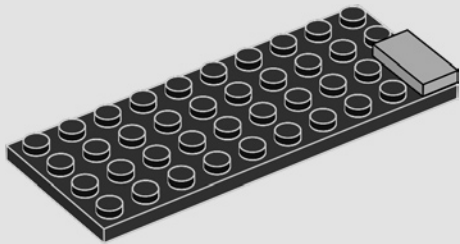

293

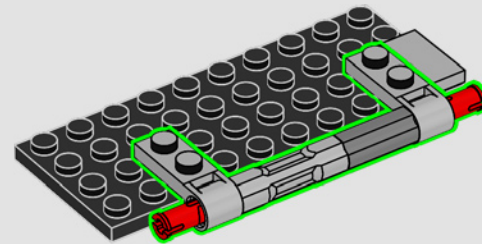
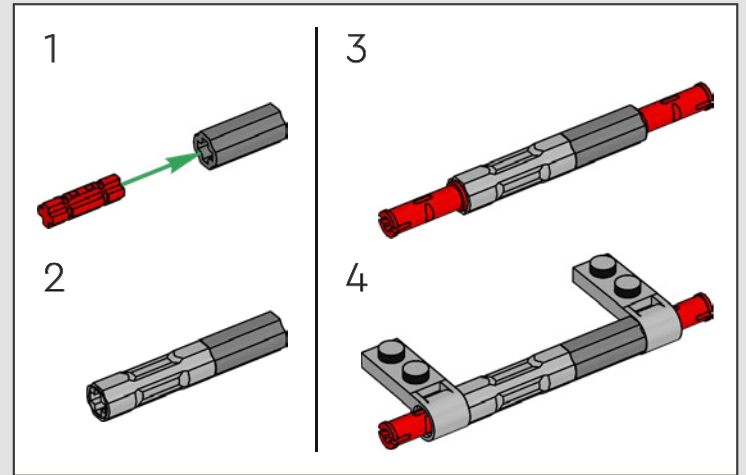

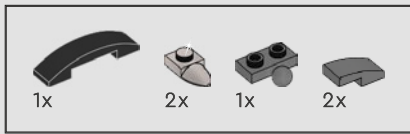

294

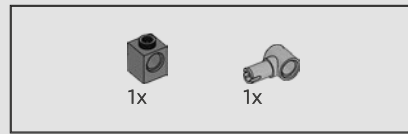
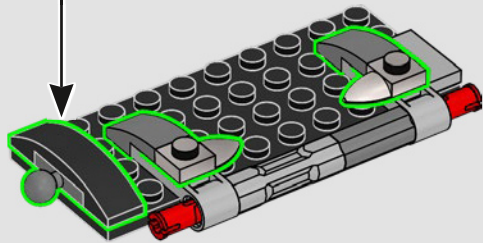
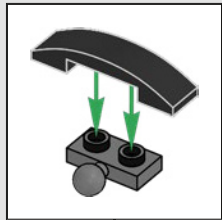

295

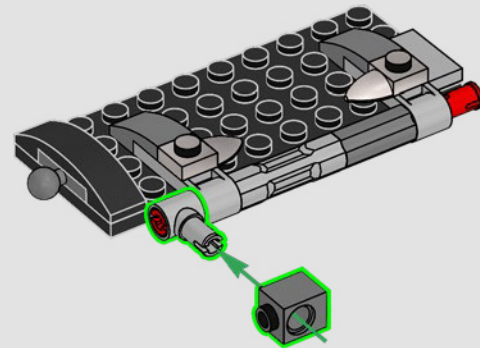

296

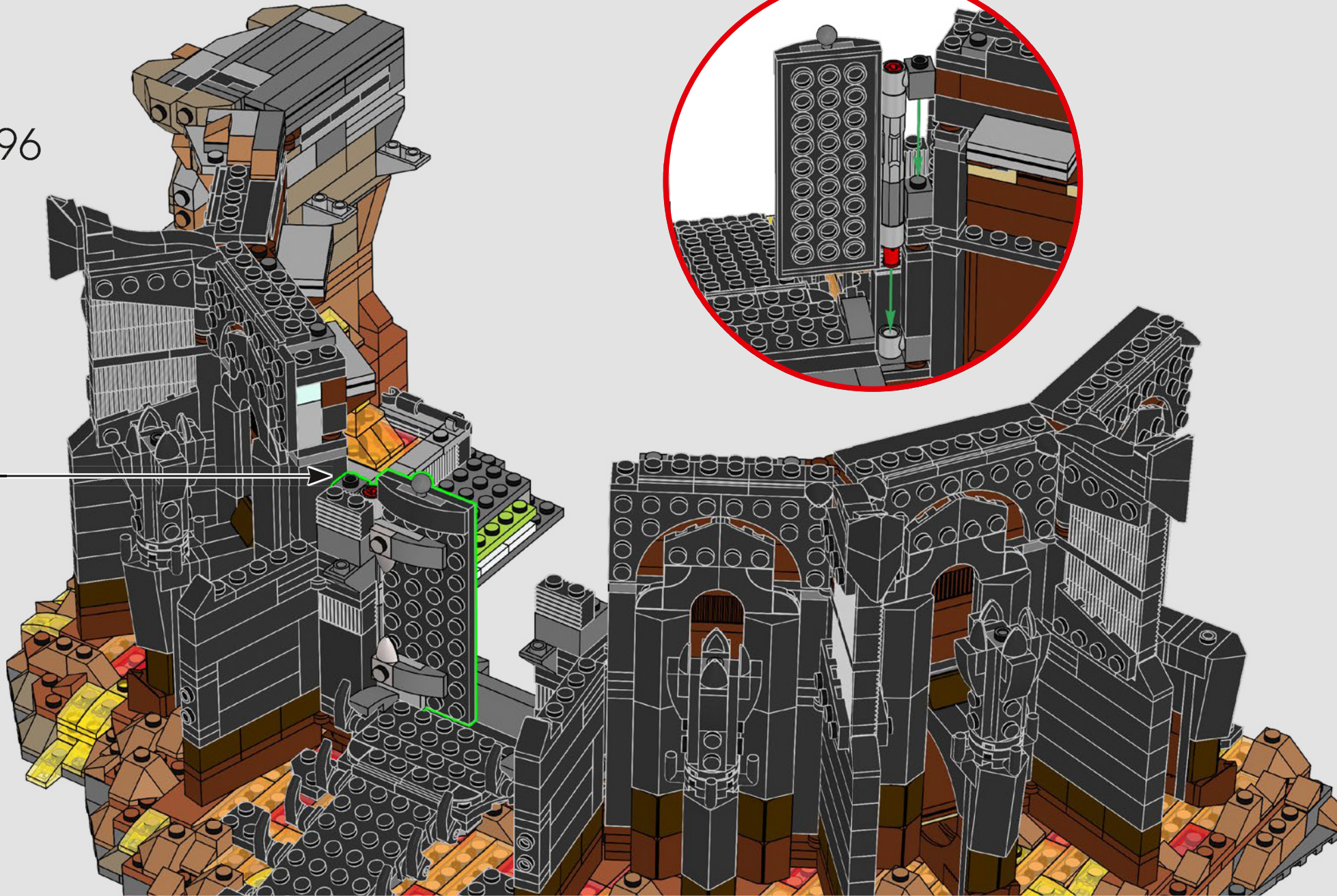

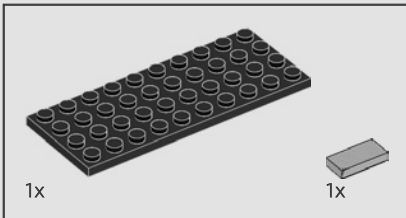
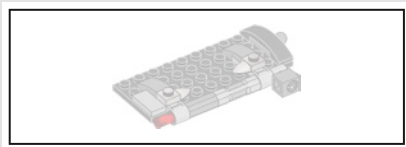

297

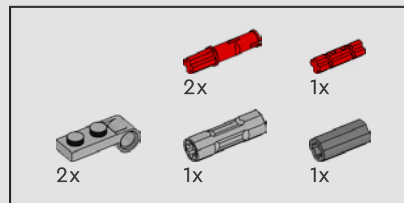
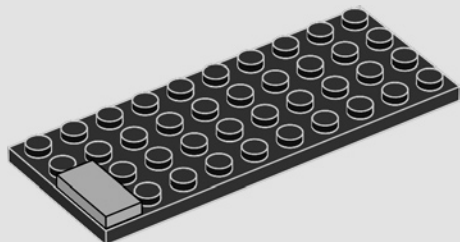

298

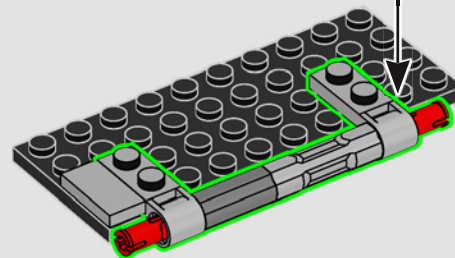
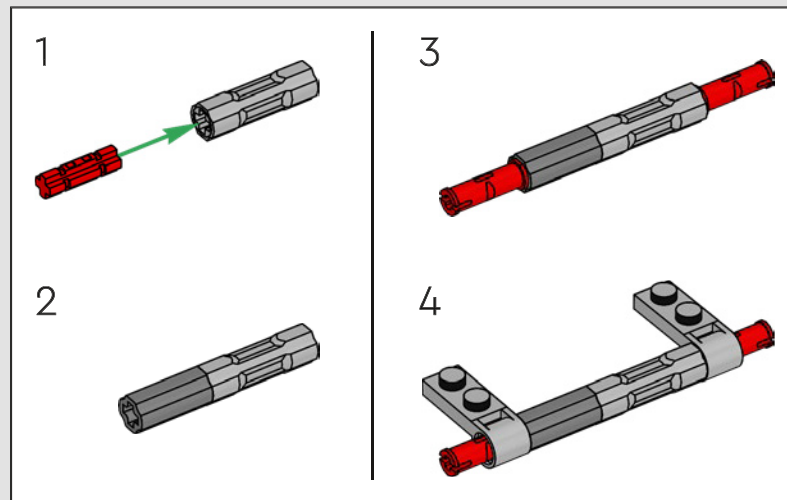

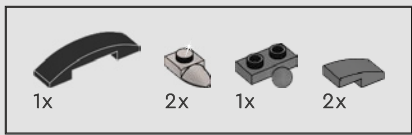

299

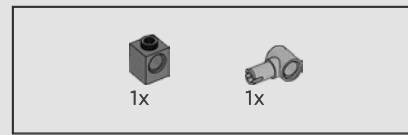
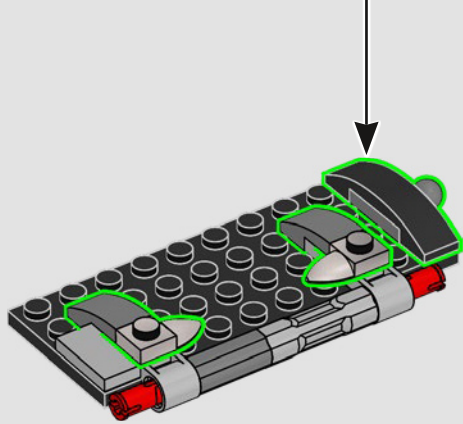
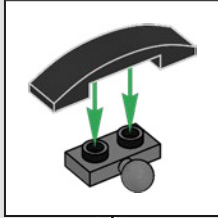

300

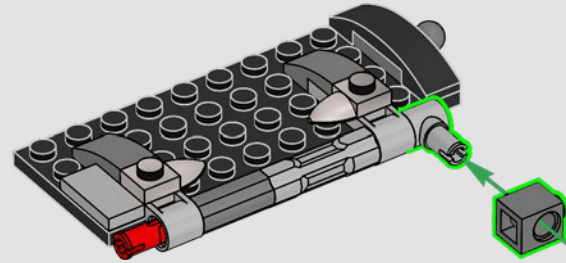

301

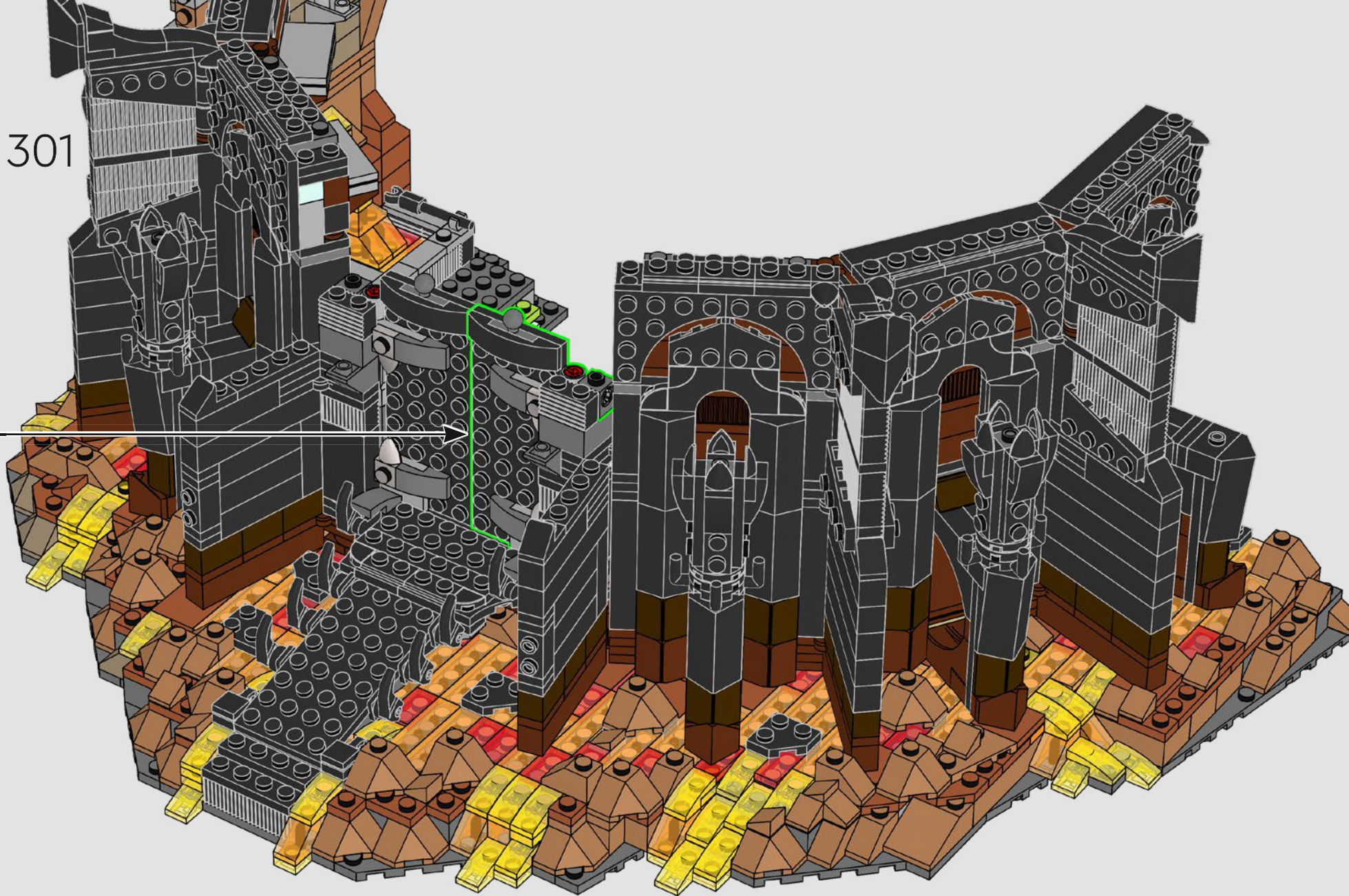

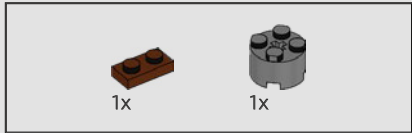
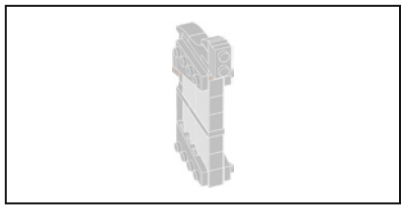

302

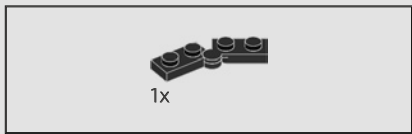
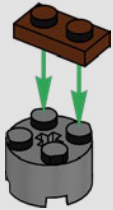

303

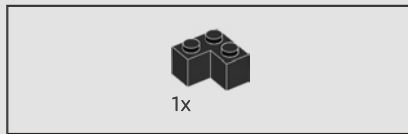
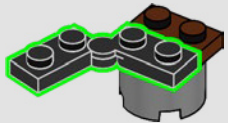

304

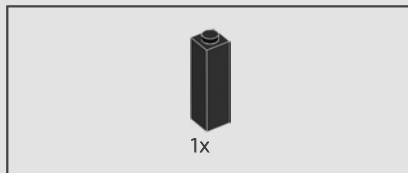
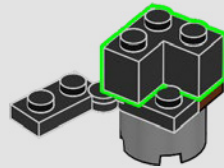

305

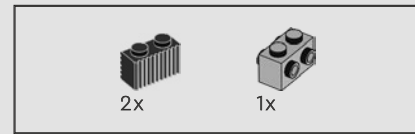
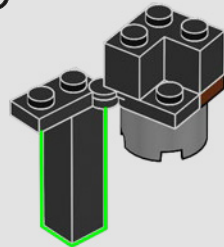

306

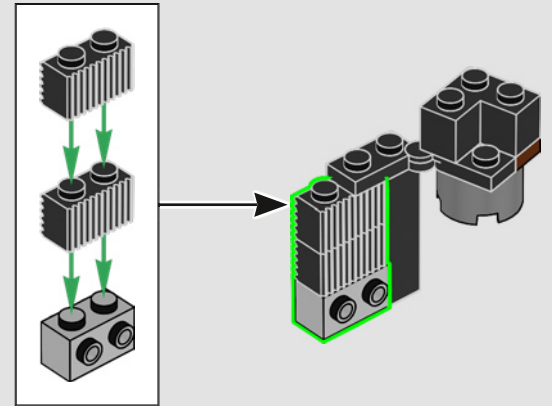

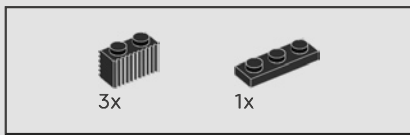

307

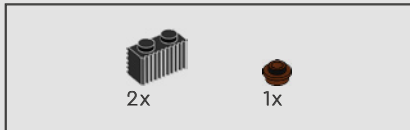
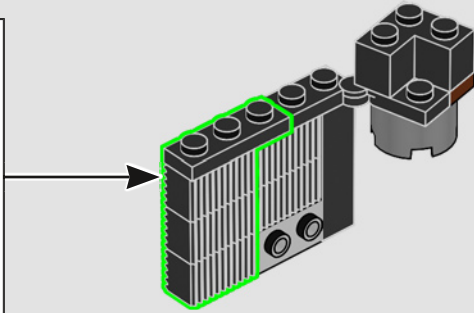
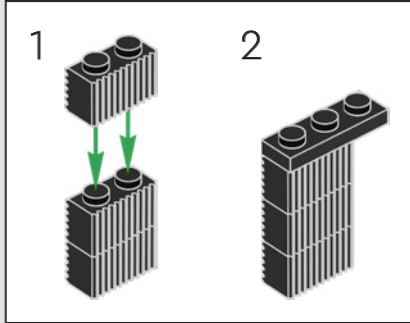

308

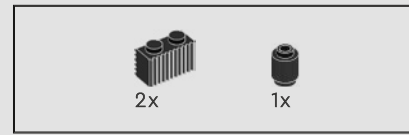
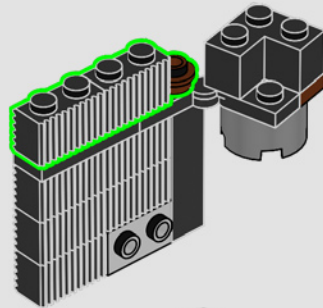

309

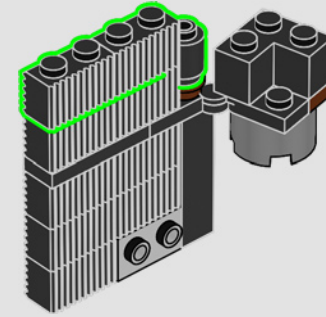

310

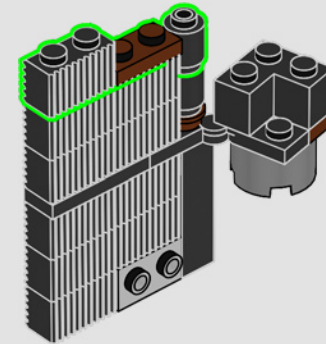



311

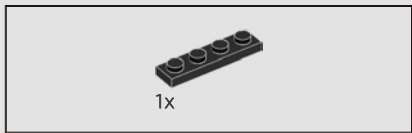
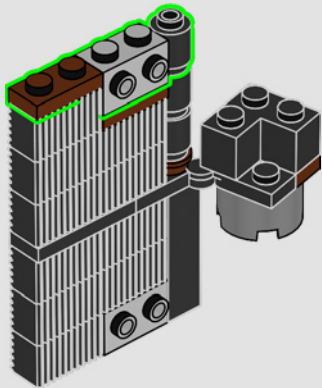

312

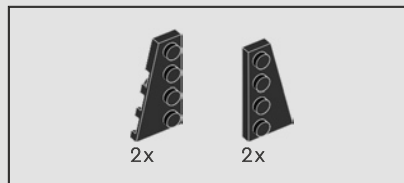
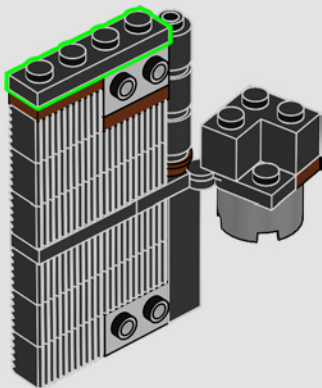

313

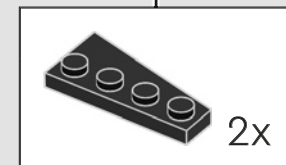
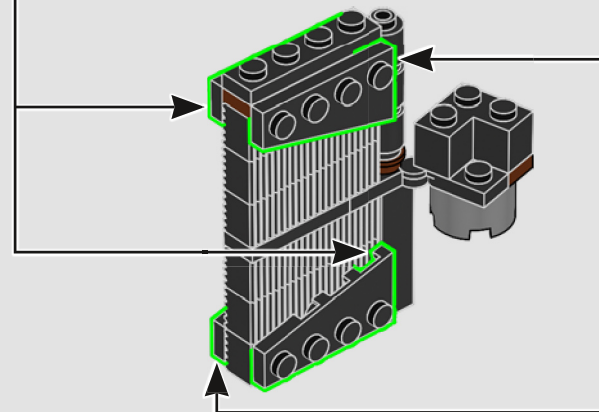
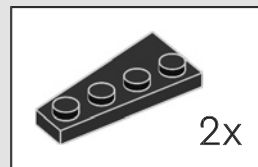



314

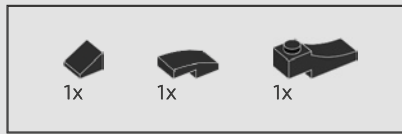
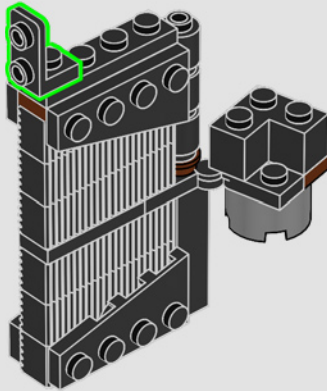

315

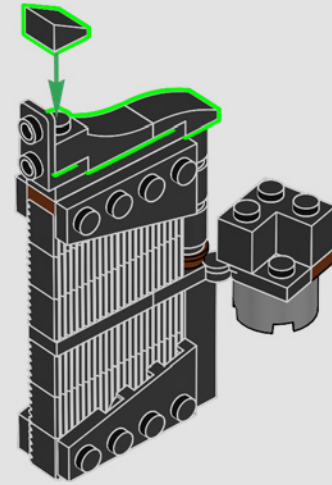

316

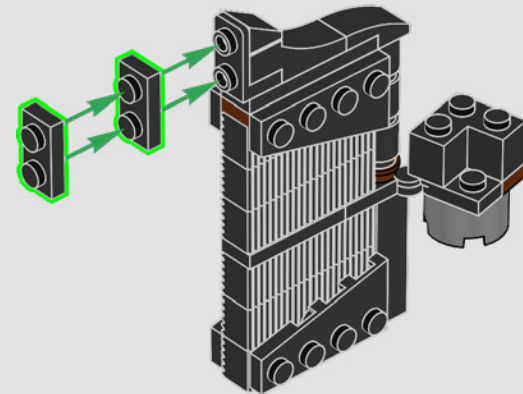



Es war Gollum™, der Sauron™ offenbarte, dass der Eine Ring im Auenland wieder aufgetaucht sei und sich jetzt im Besitz eines Hobbits namens Beutlin befände.

317

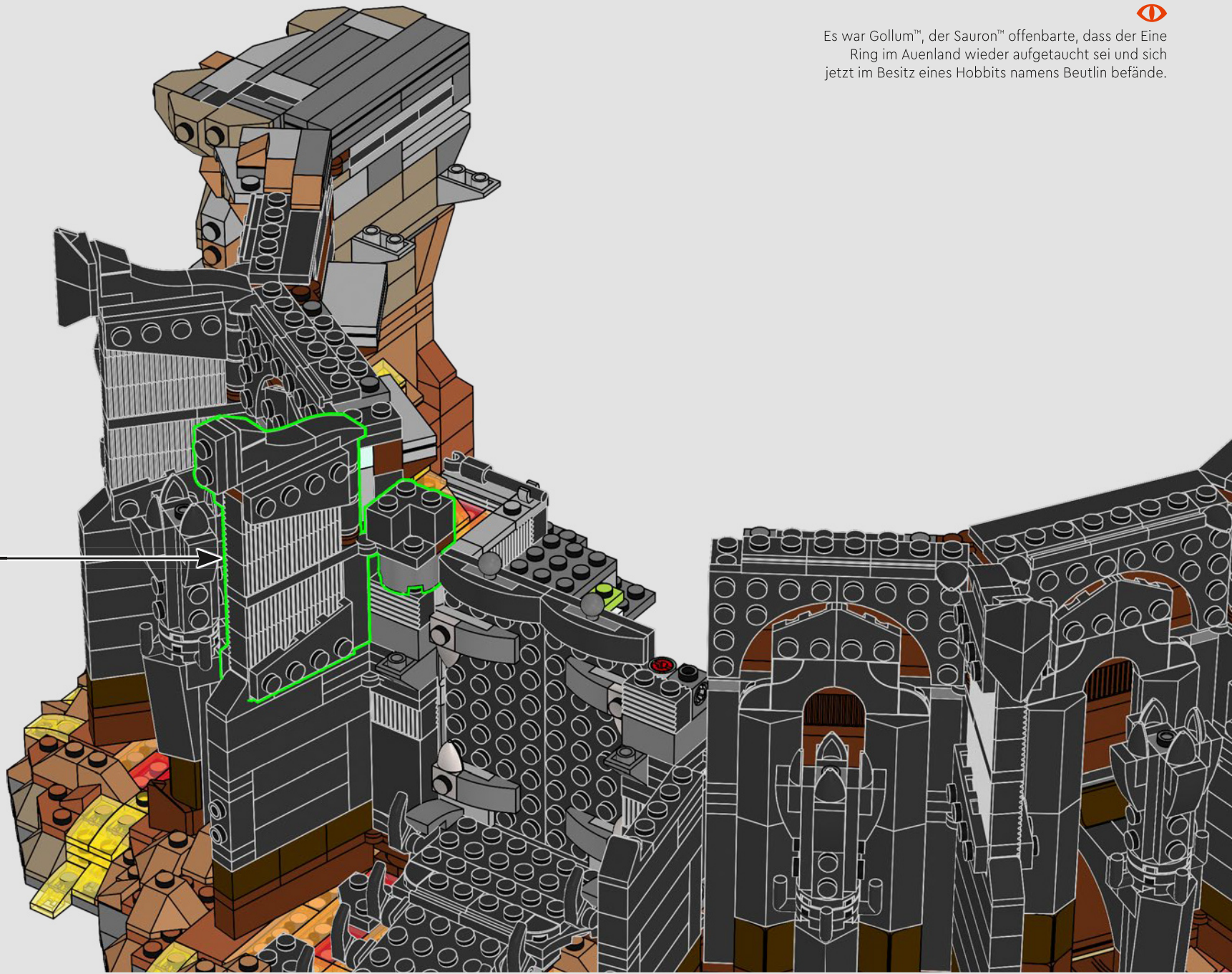

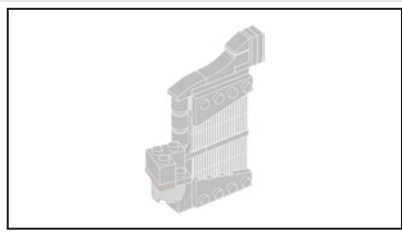

318

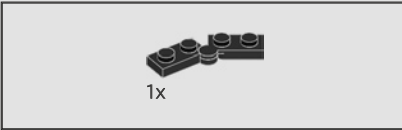
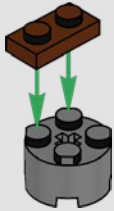

319

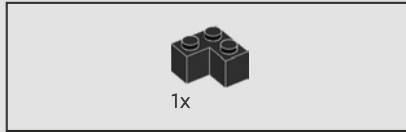
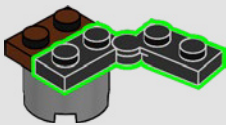

320

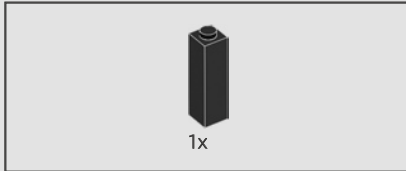
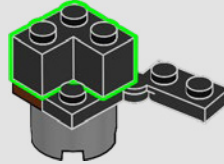

321

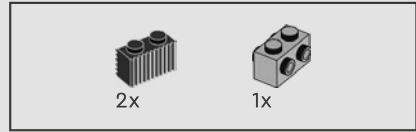
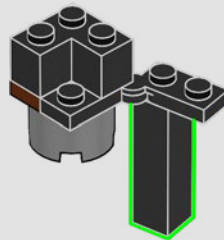

322

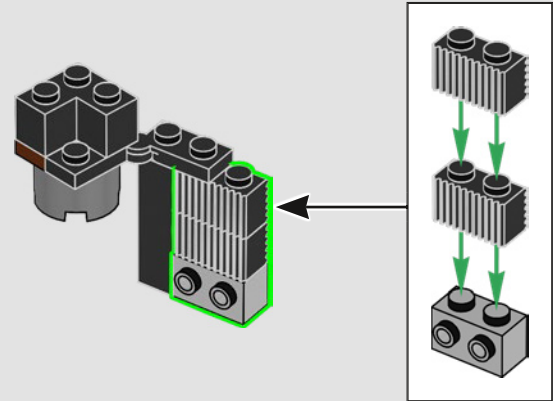

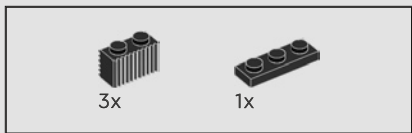

323

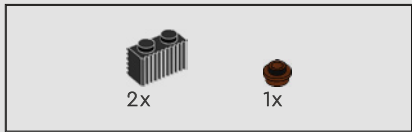
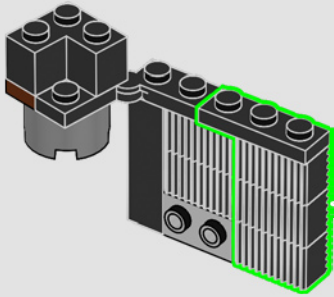
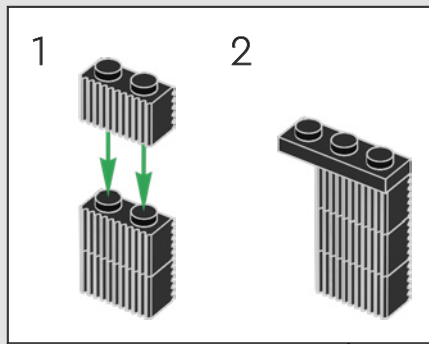

324

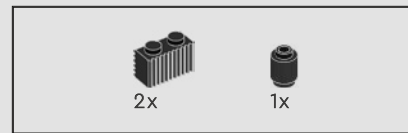
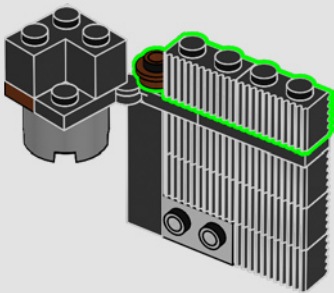

325

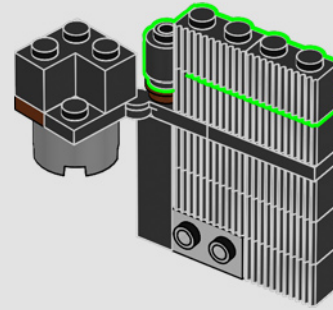

326

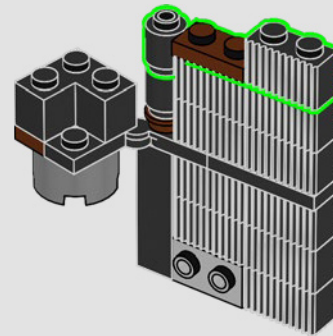



327

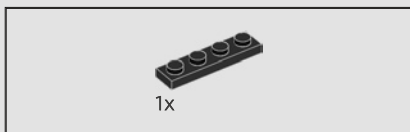
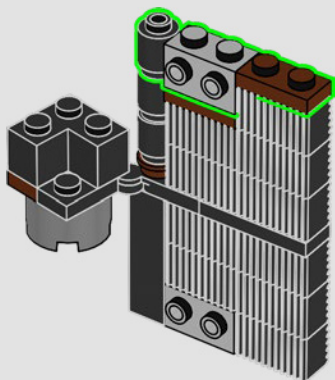

328

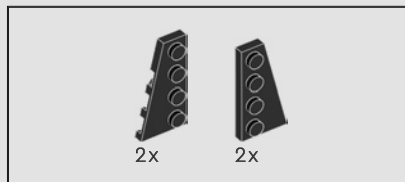
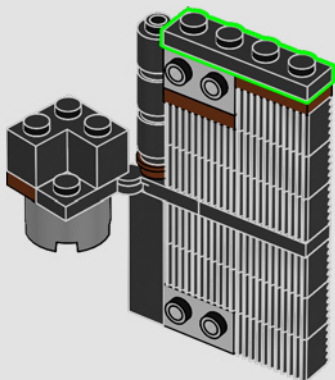

329

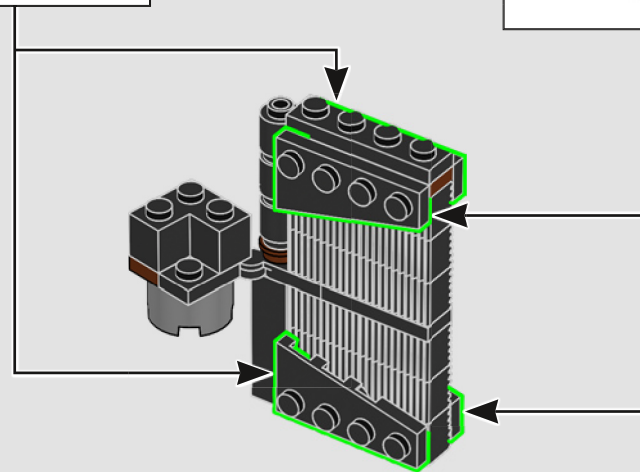
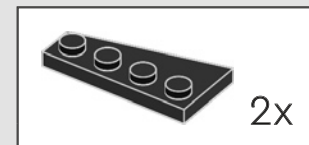
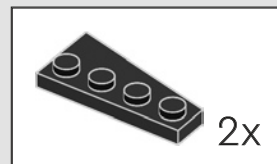



1x

330

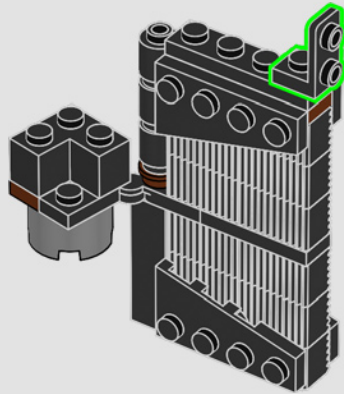

1x



1x



1x

331

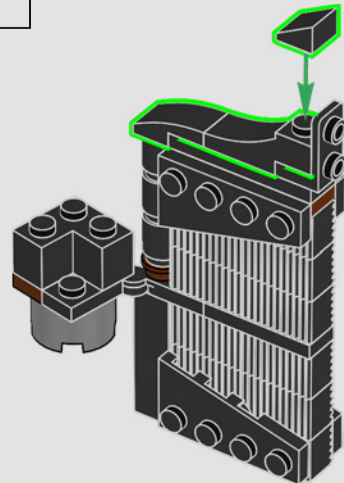

2x

332

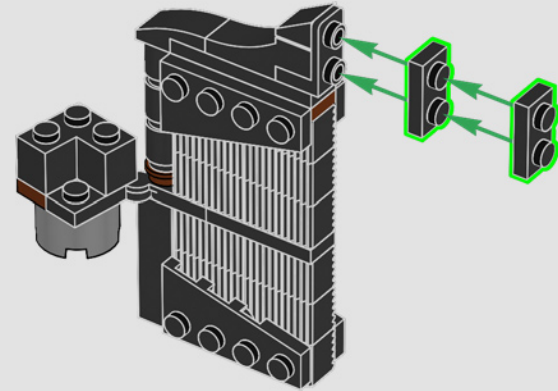

333

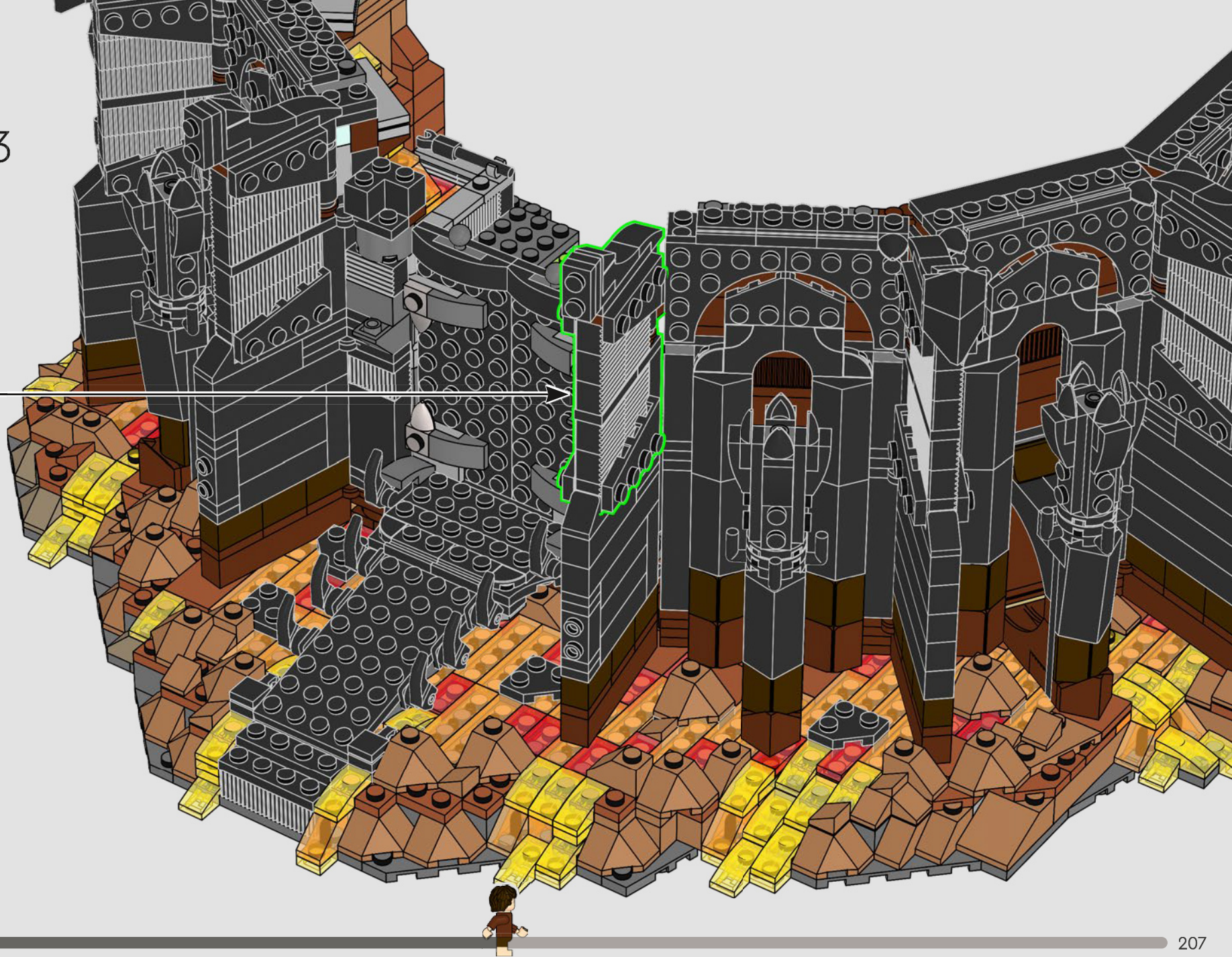

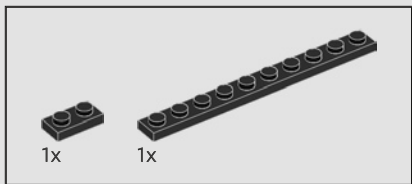

334

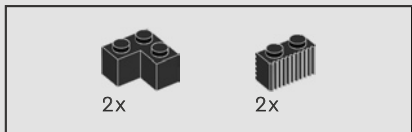
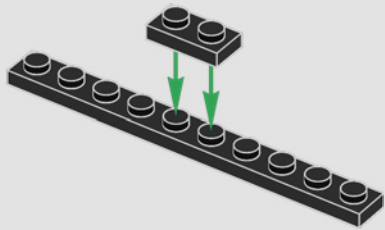

335

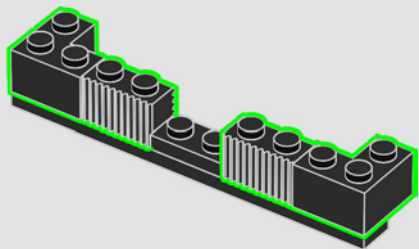

336

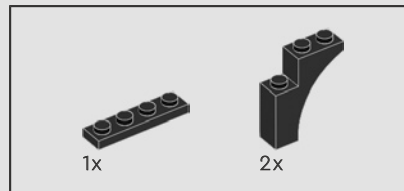
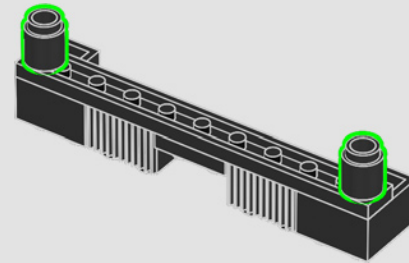
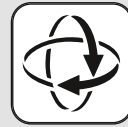

337

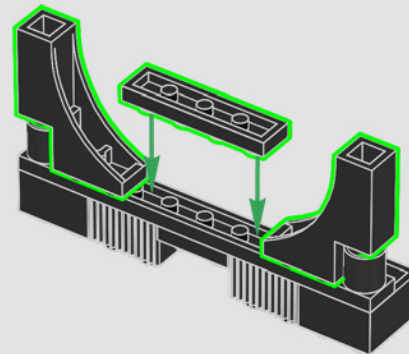

338

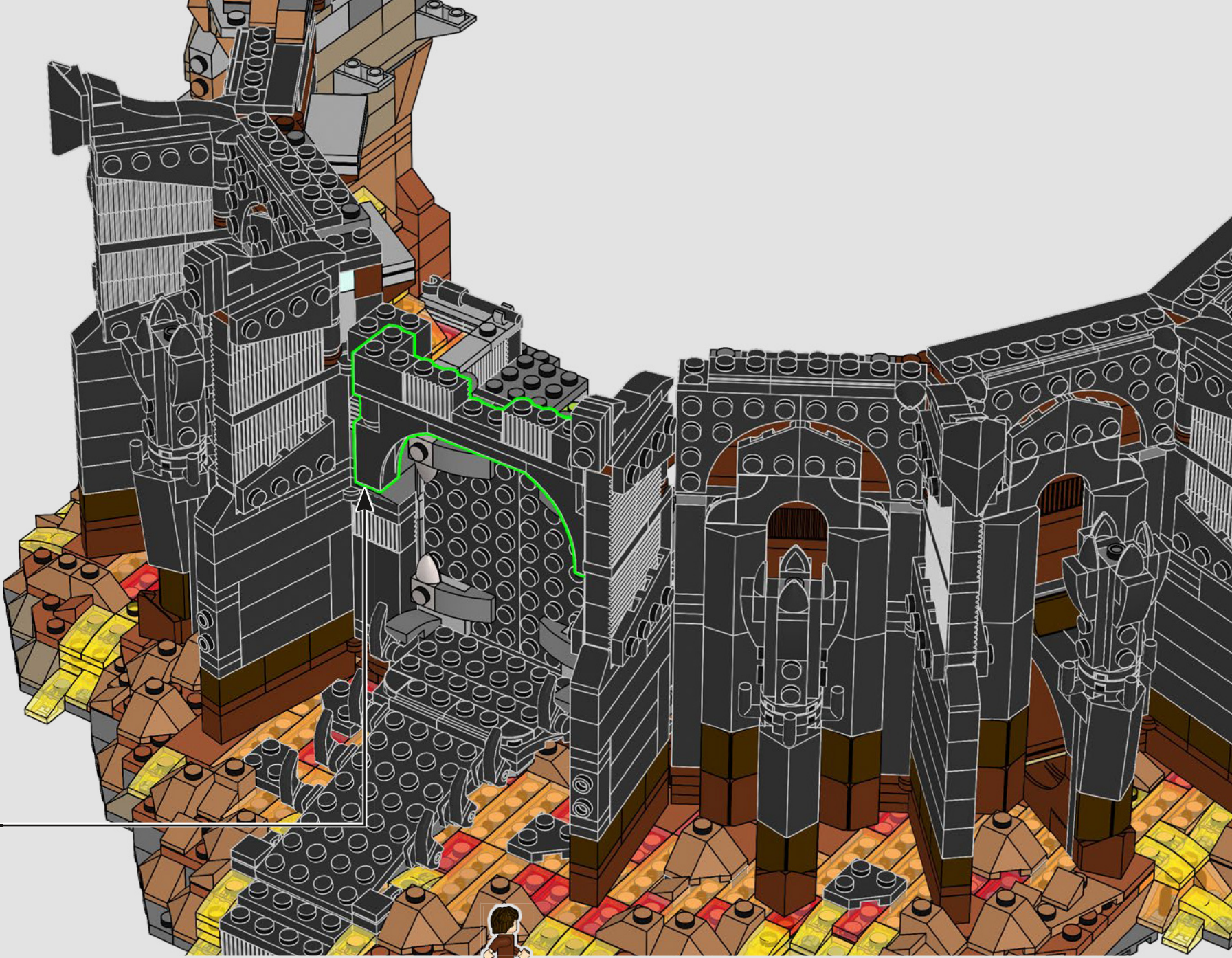

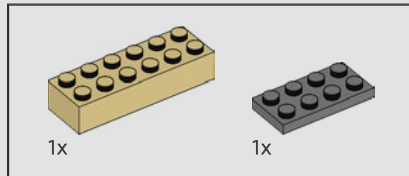
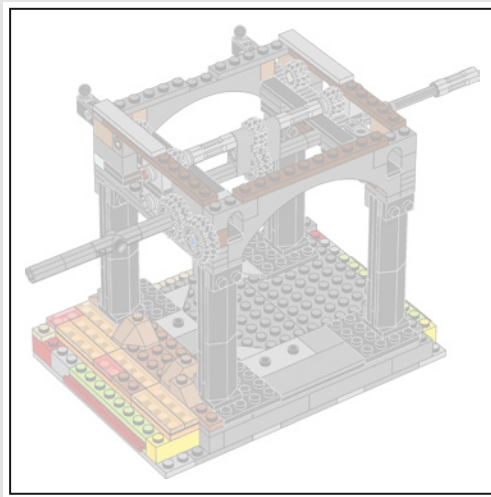

339

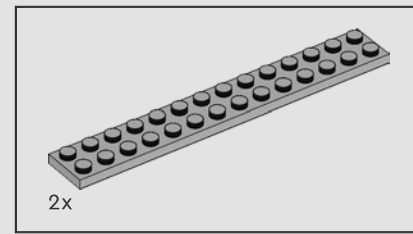
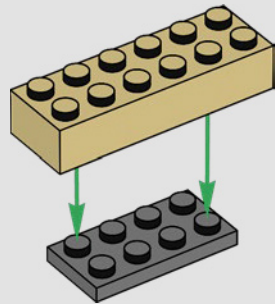

340

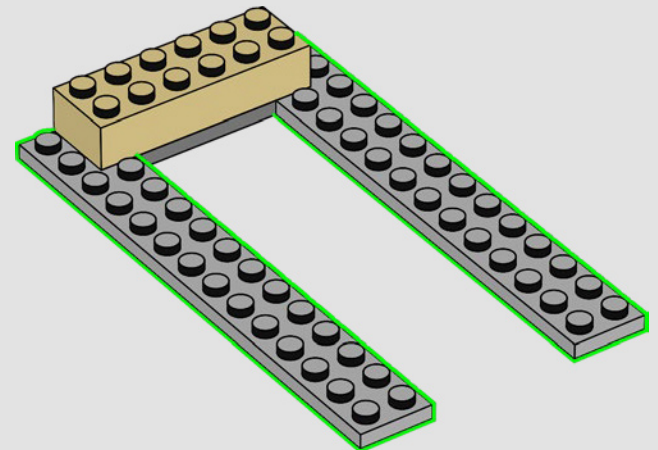

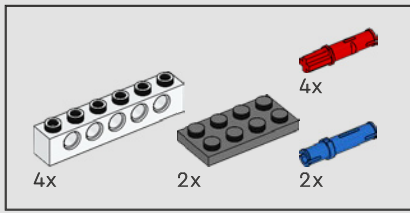

341

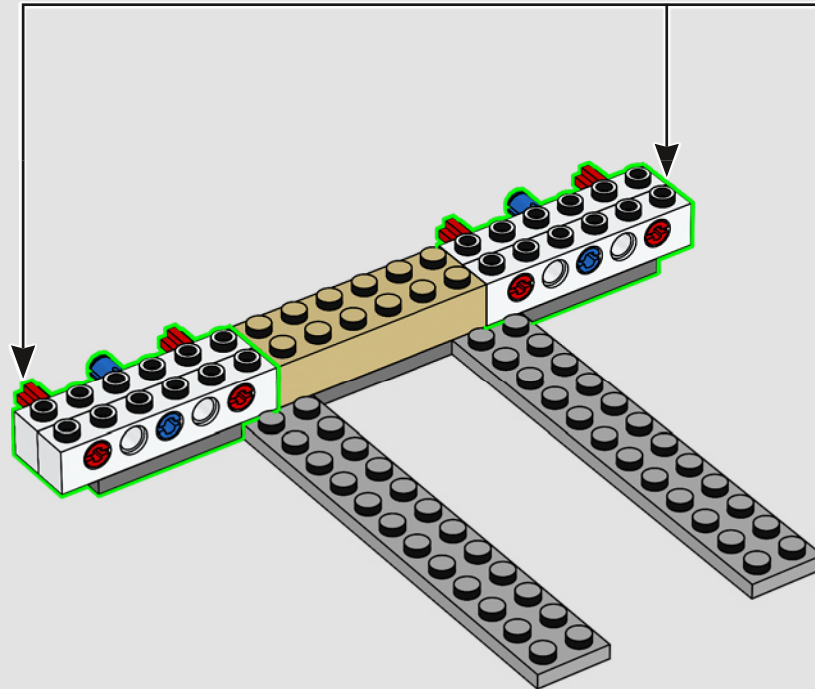
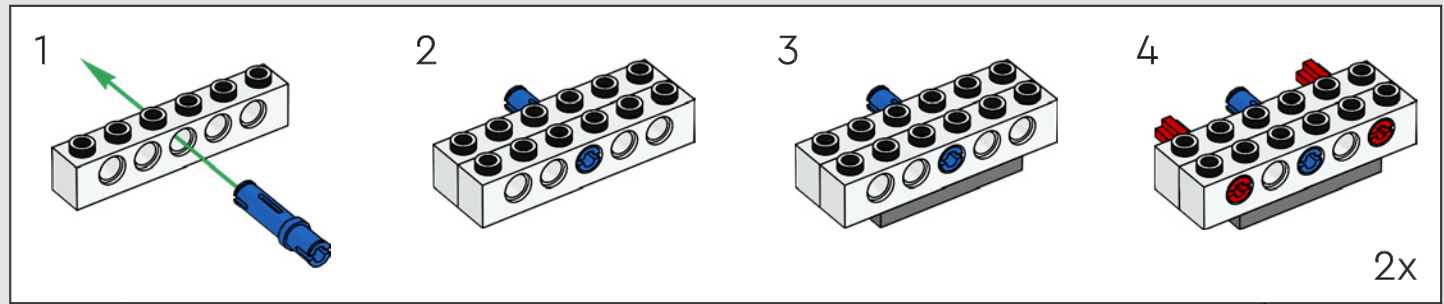

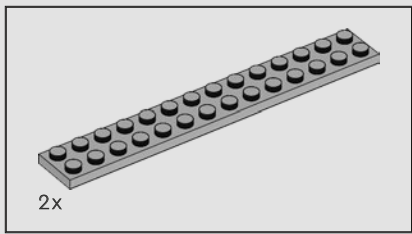

342

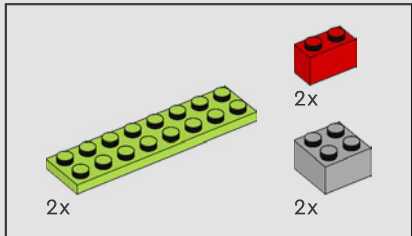
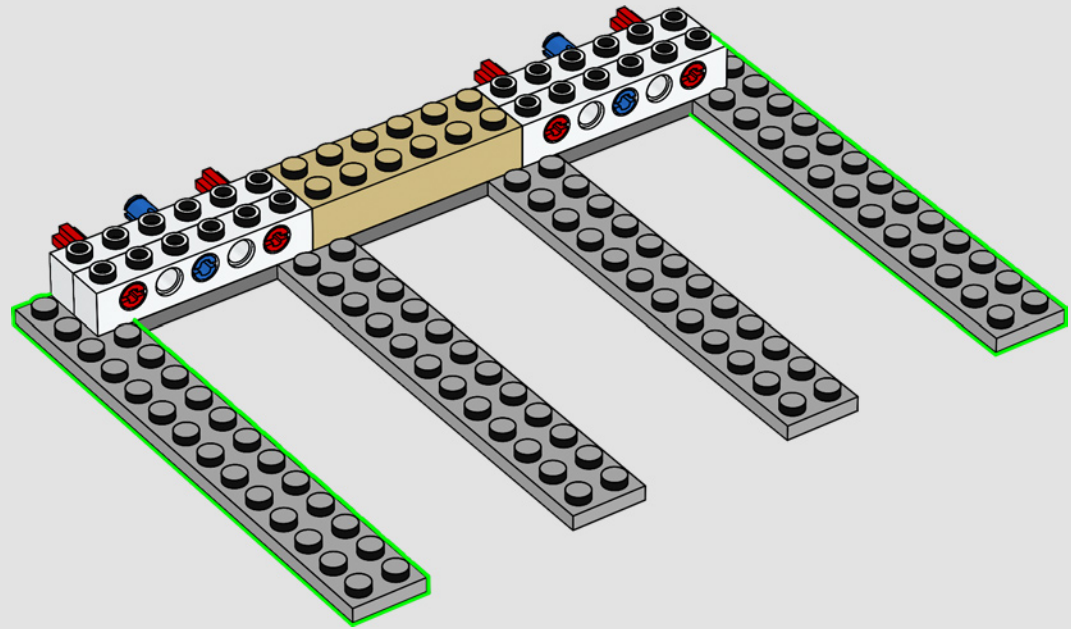

343

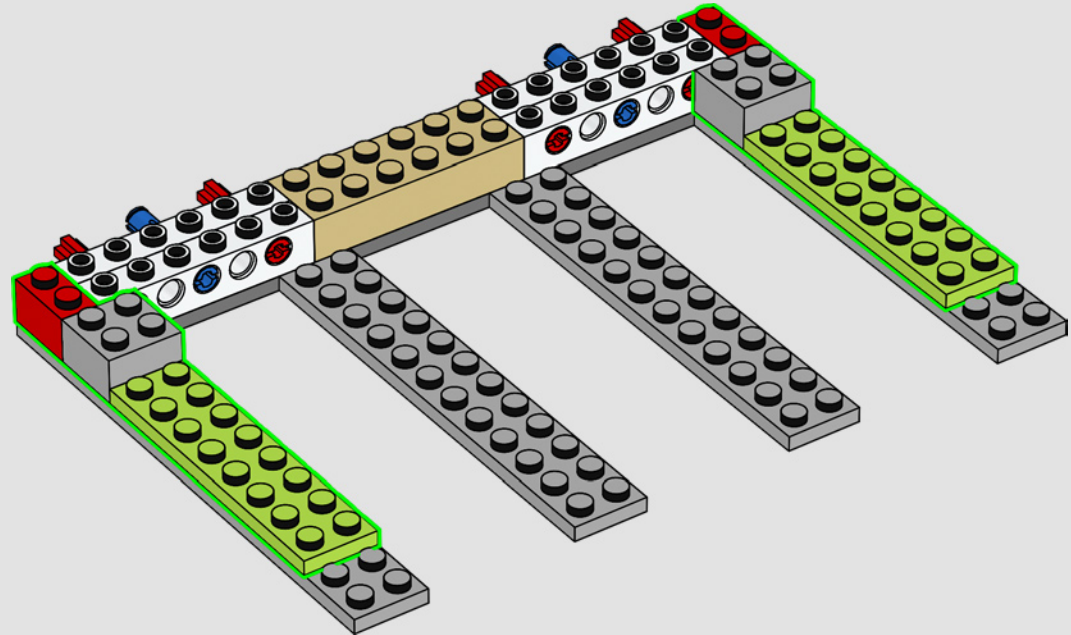

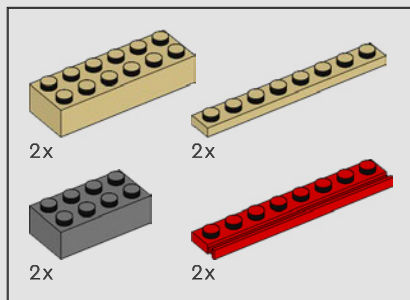

344

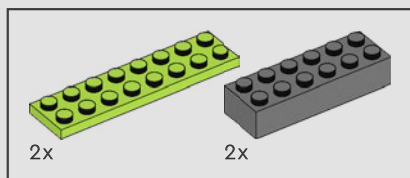
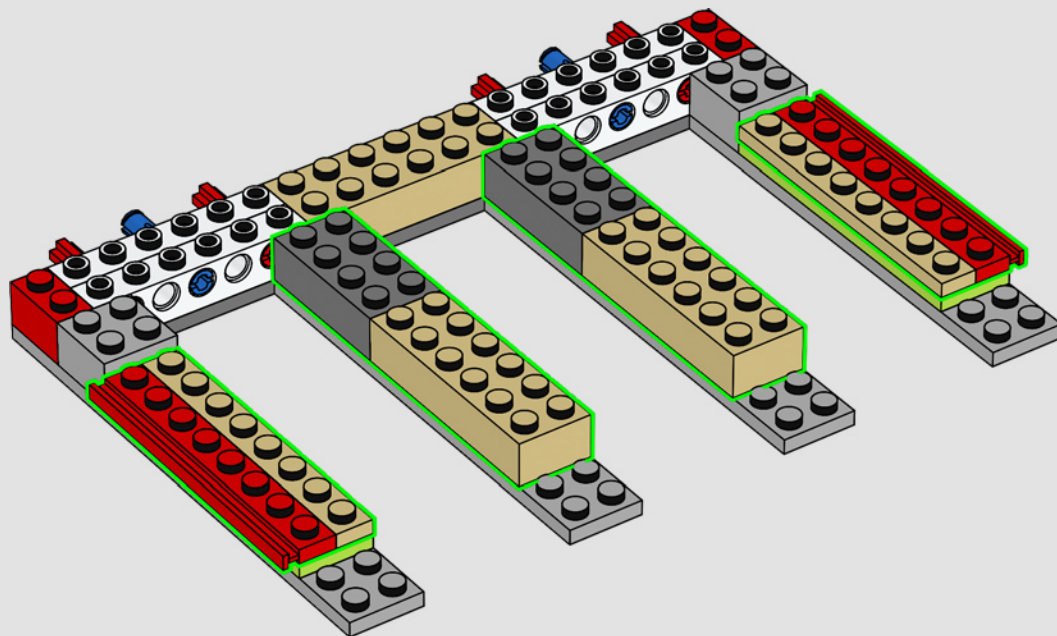

345

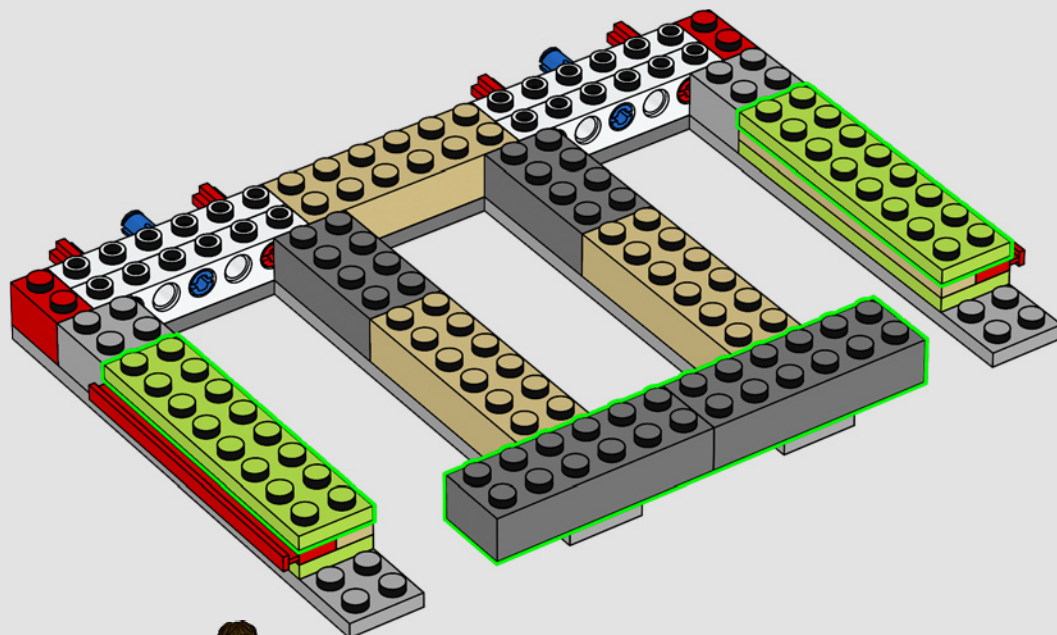

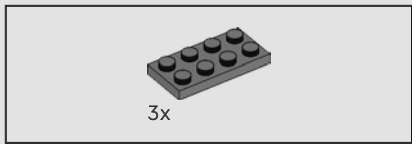

346

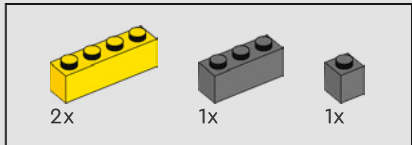
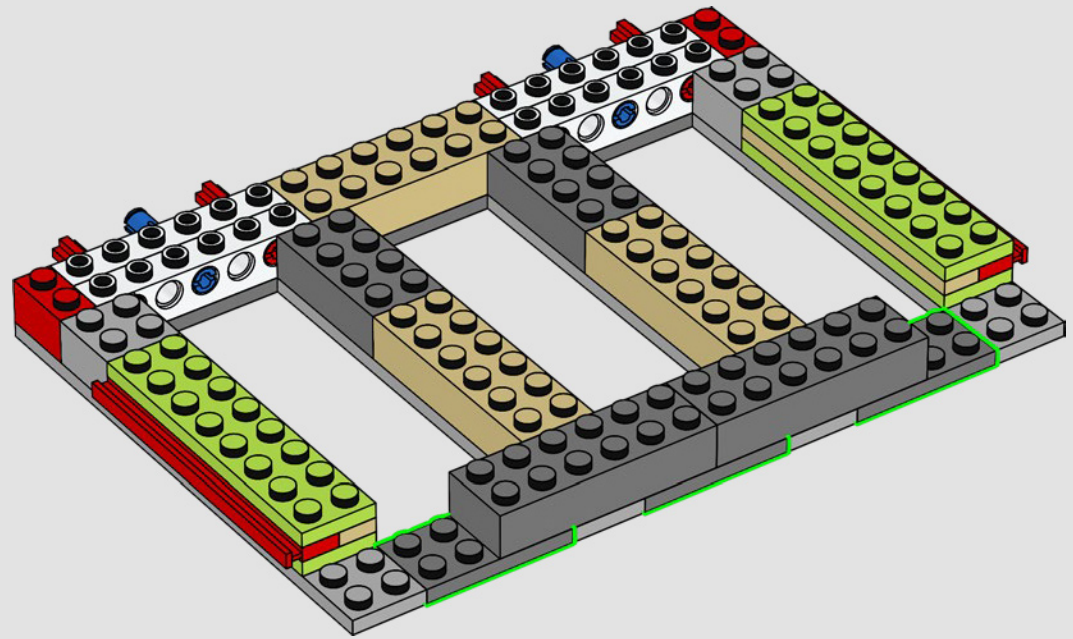

347

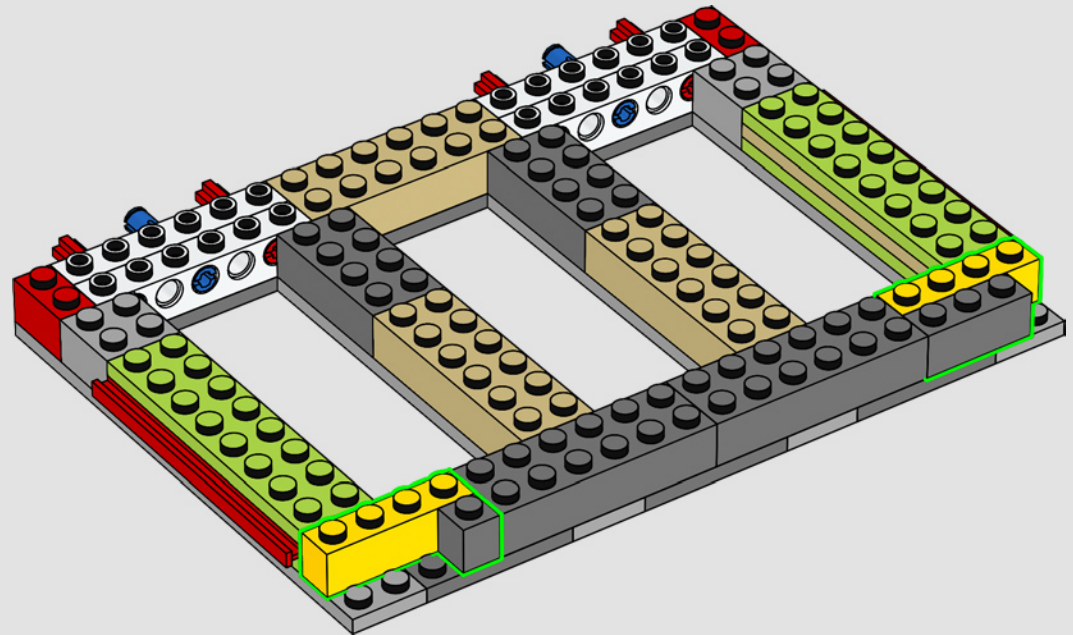

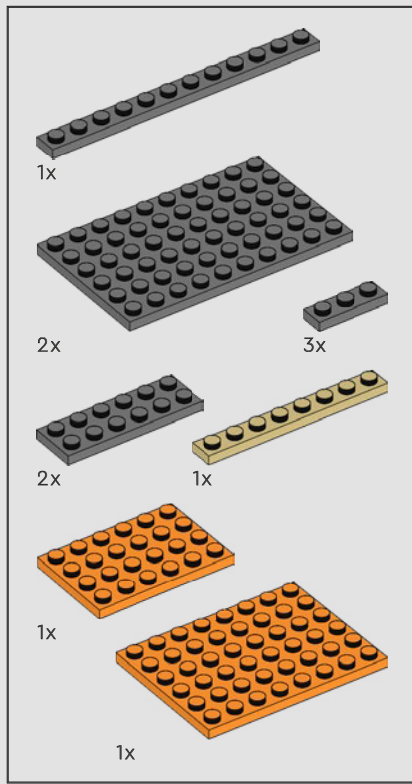

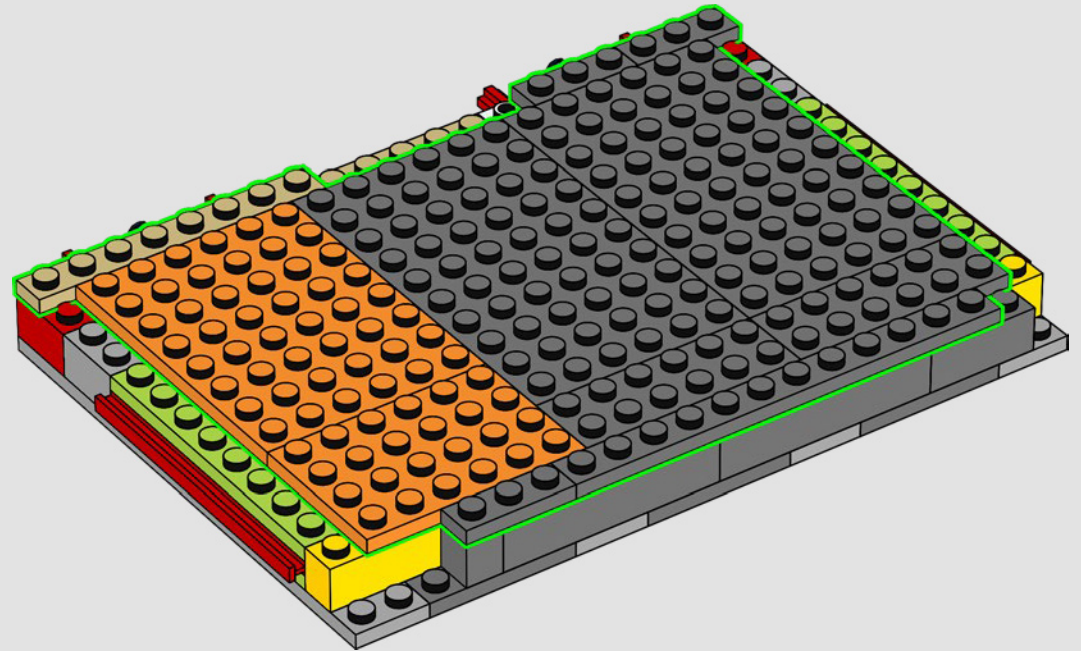

348

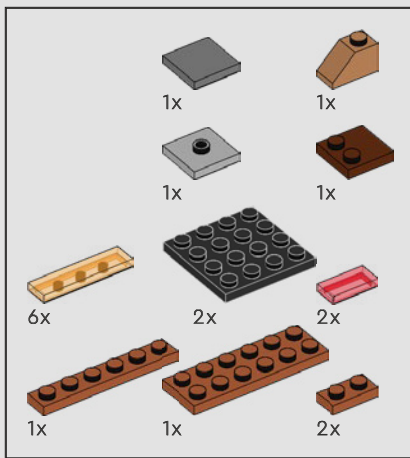

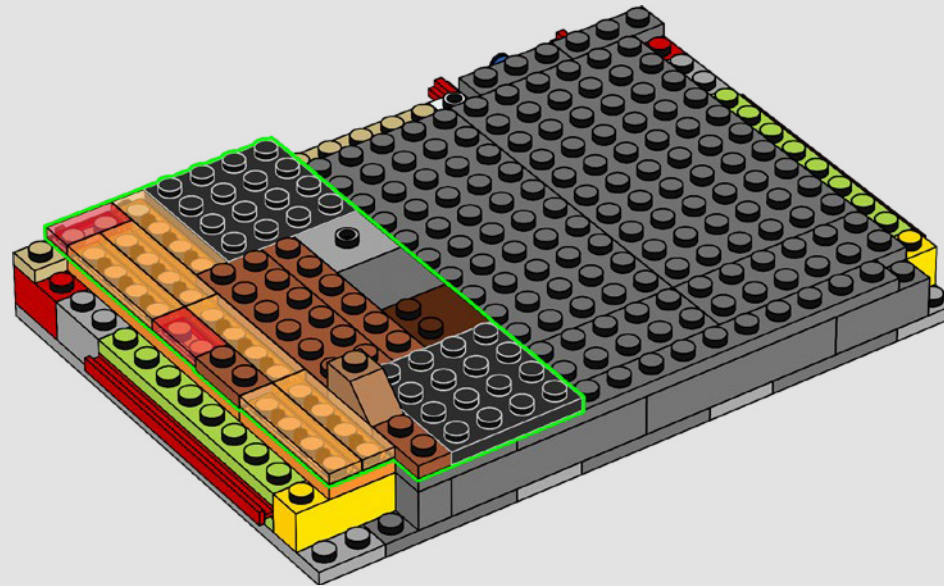

349



 Dieses Segment wird separat gebaut, um den bestmöglichen Überblick über den Baufortschritt zu haben, und dann in die Mitte des Modells eingeschoben und dort verriegelt.

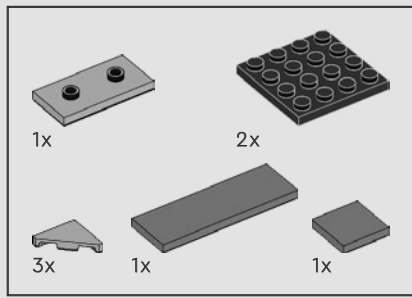

350

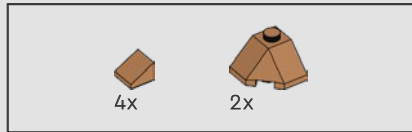
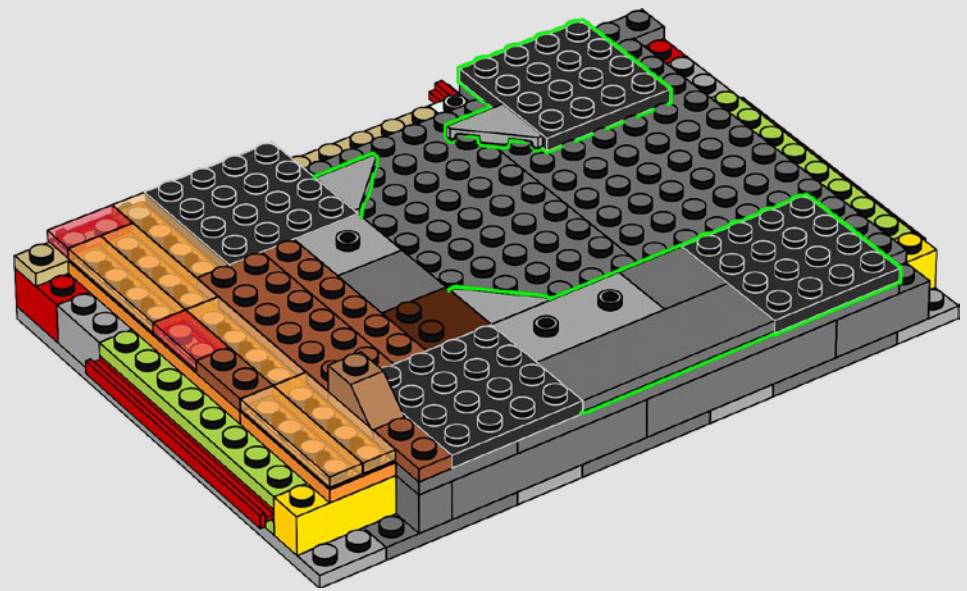

351

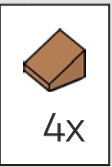
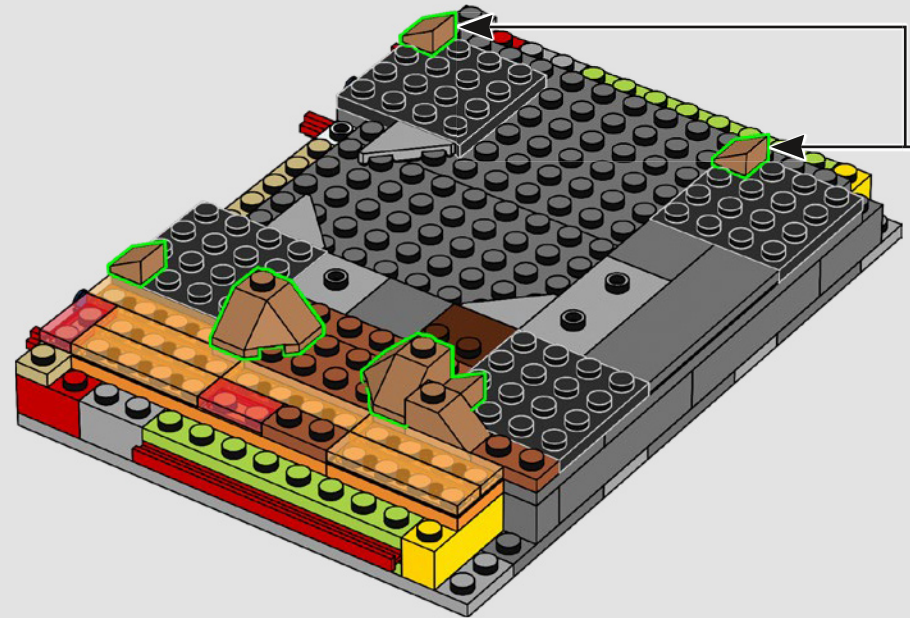

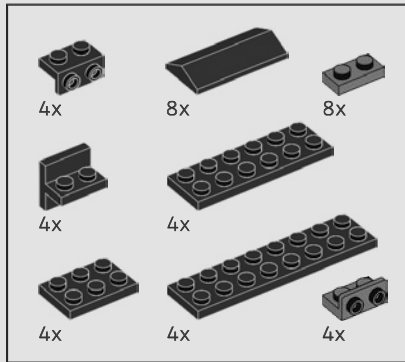
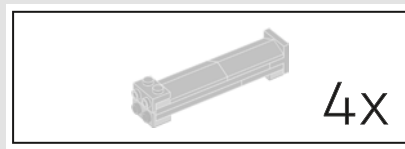

352

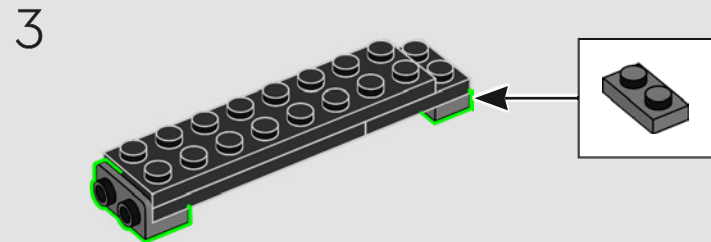
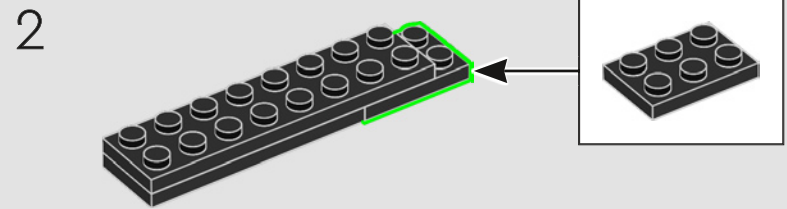
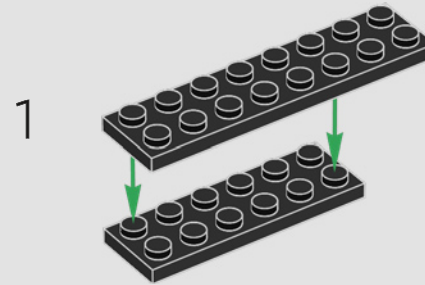

4

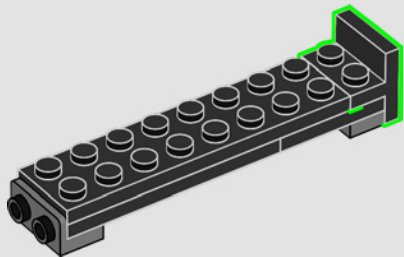

5

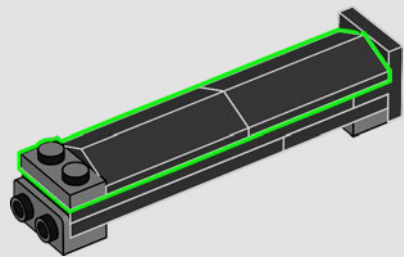

6

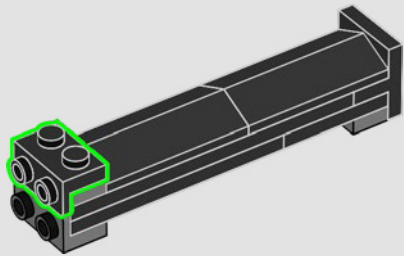

4x

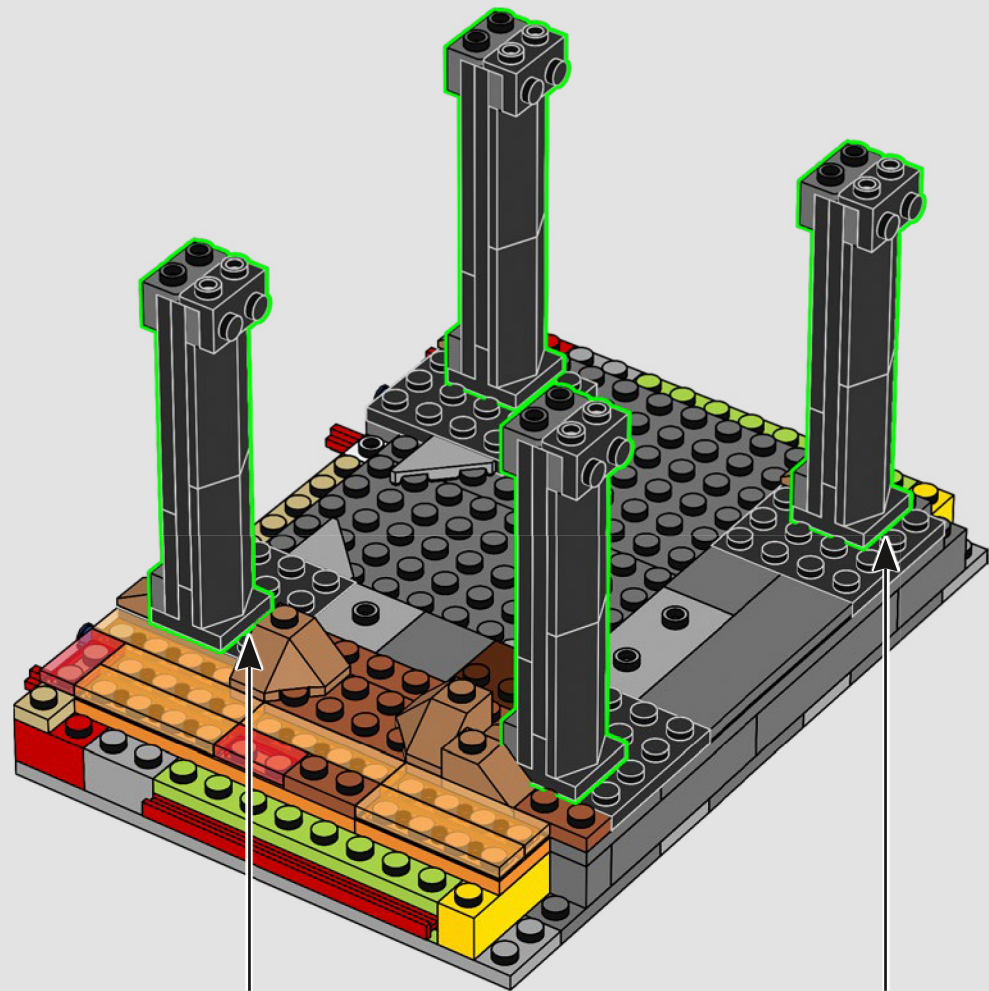

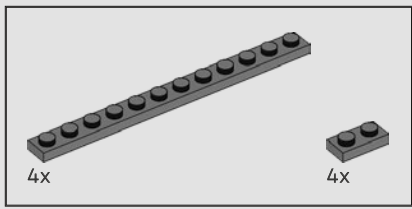

353

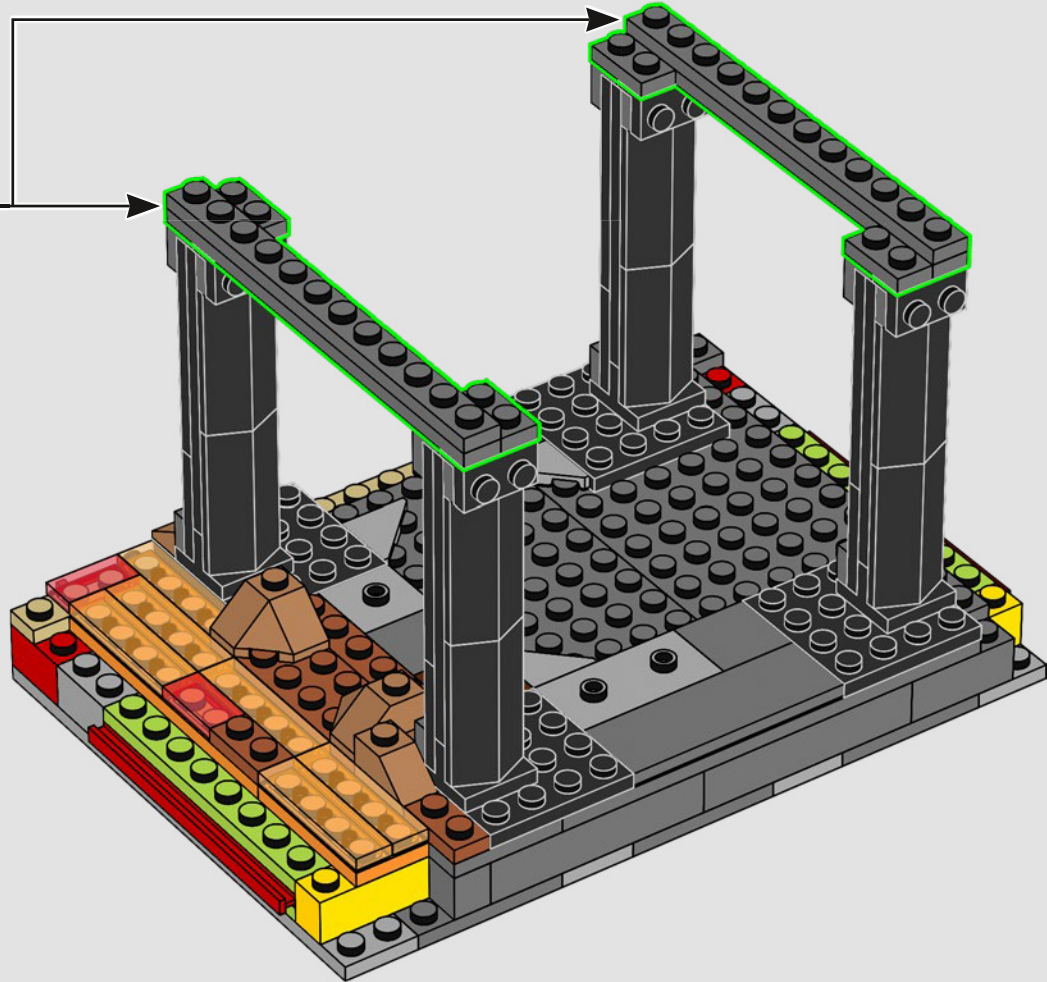
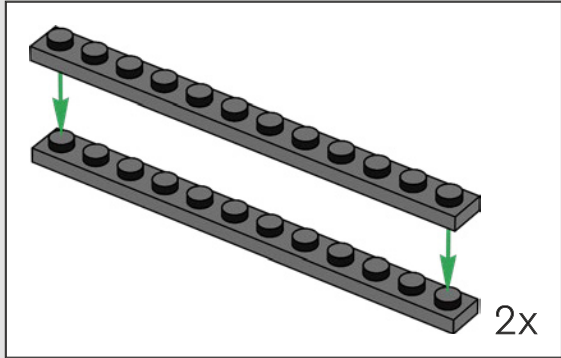

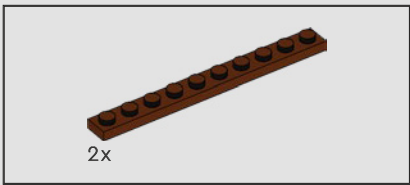

354

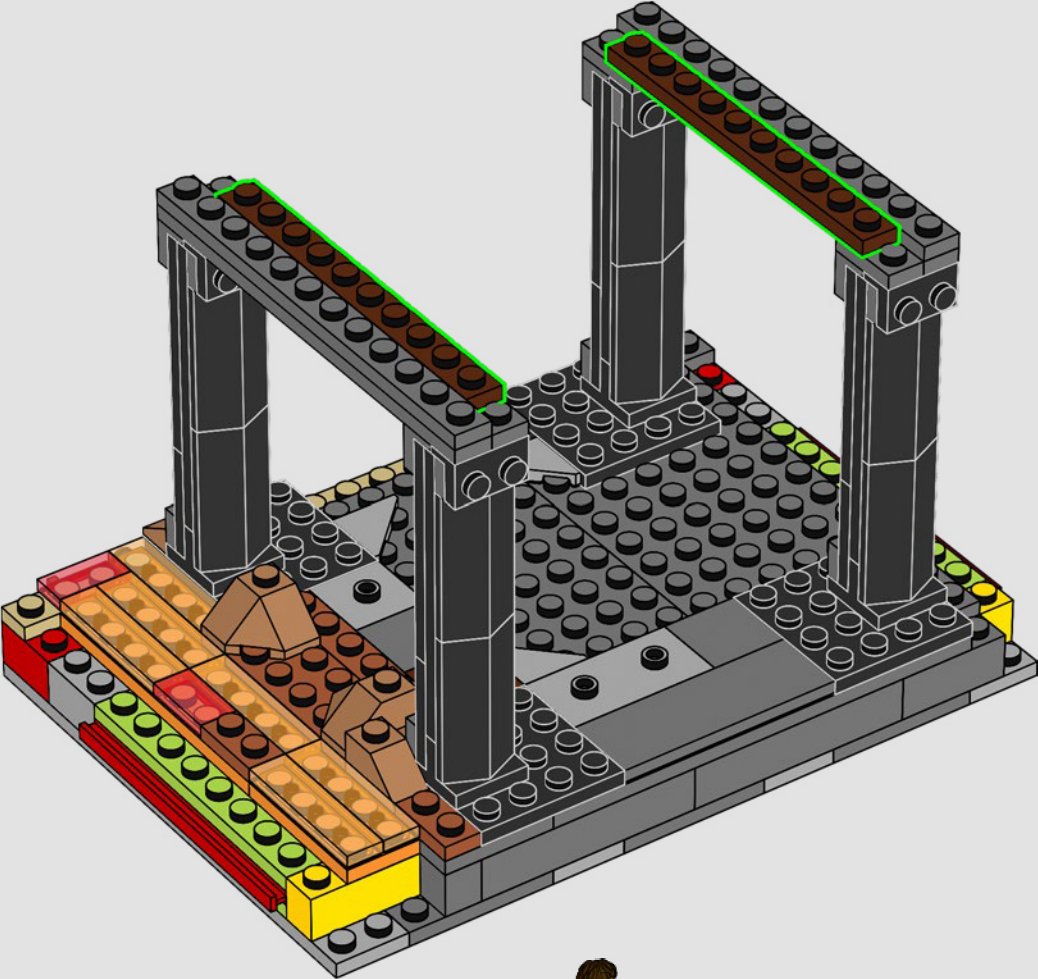

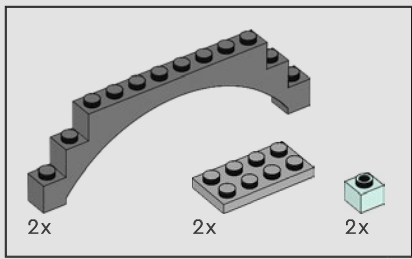

355

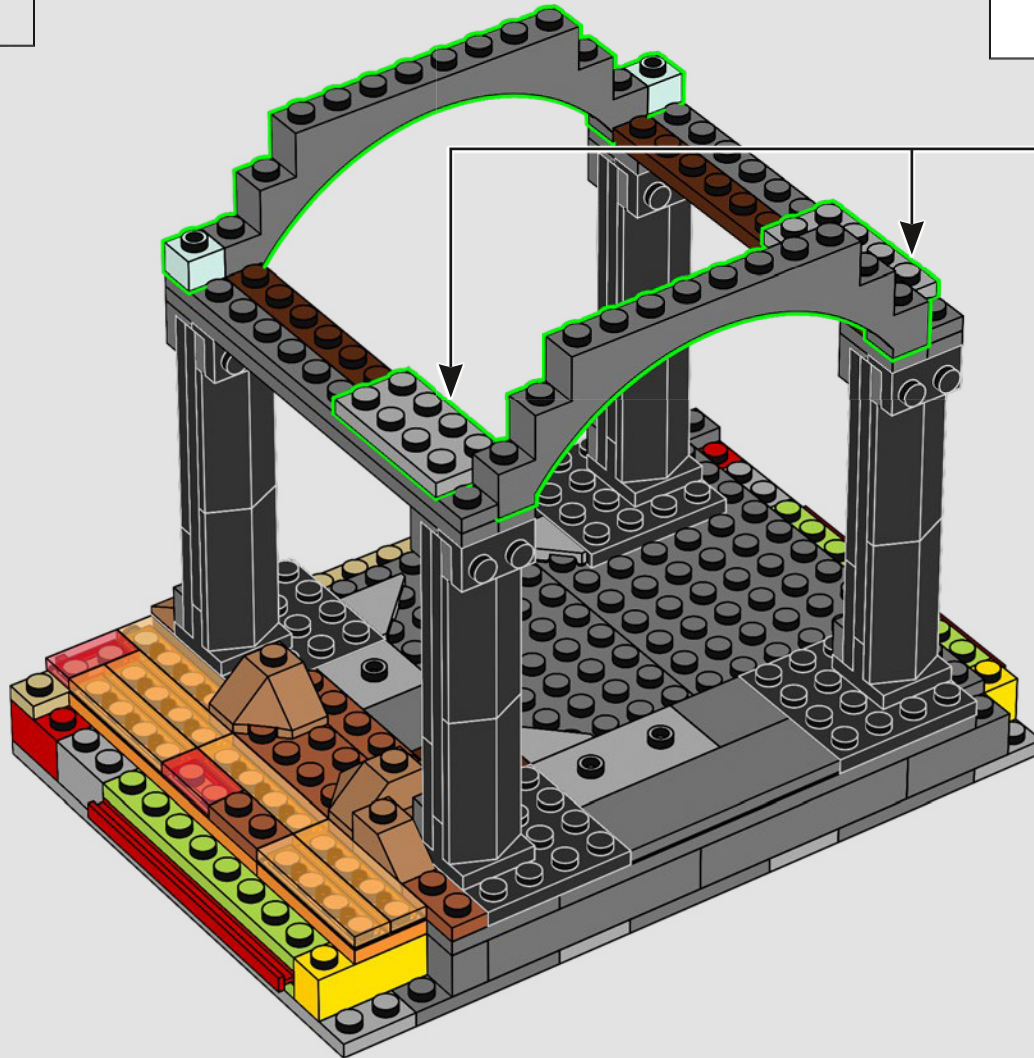
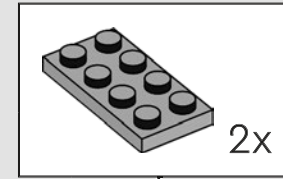

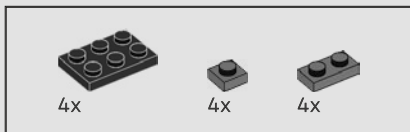

356

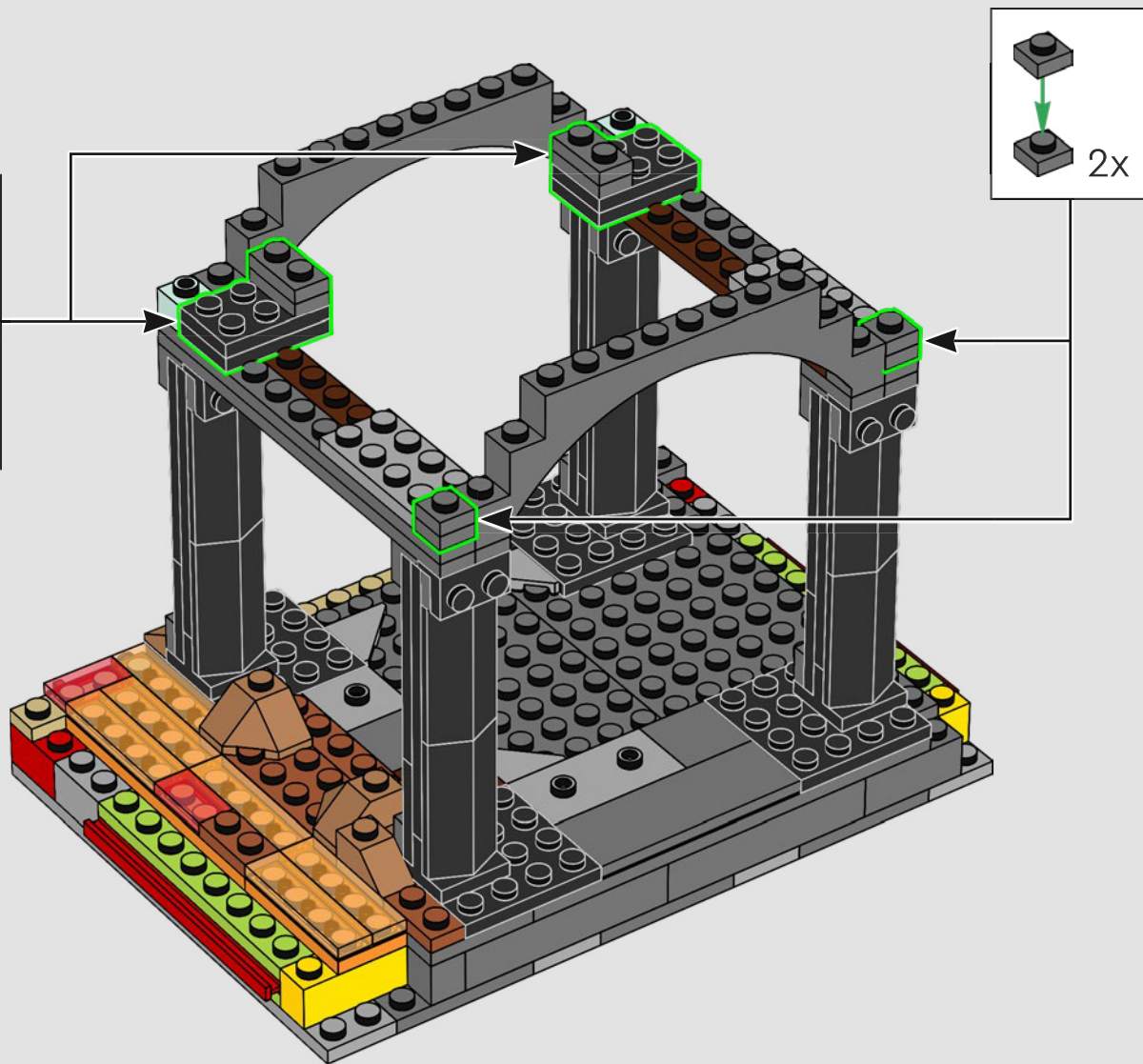
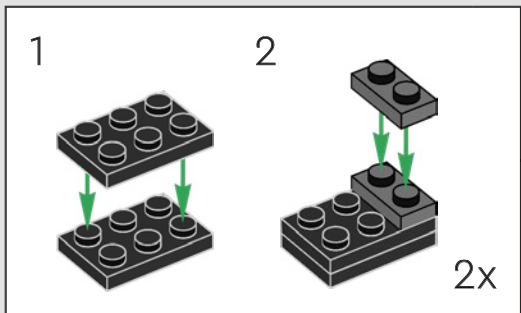

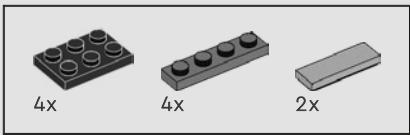

357

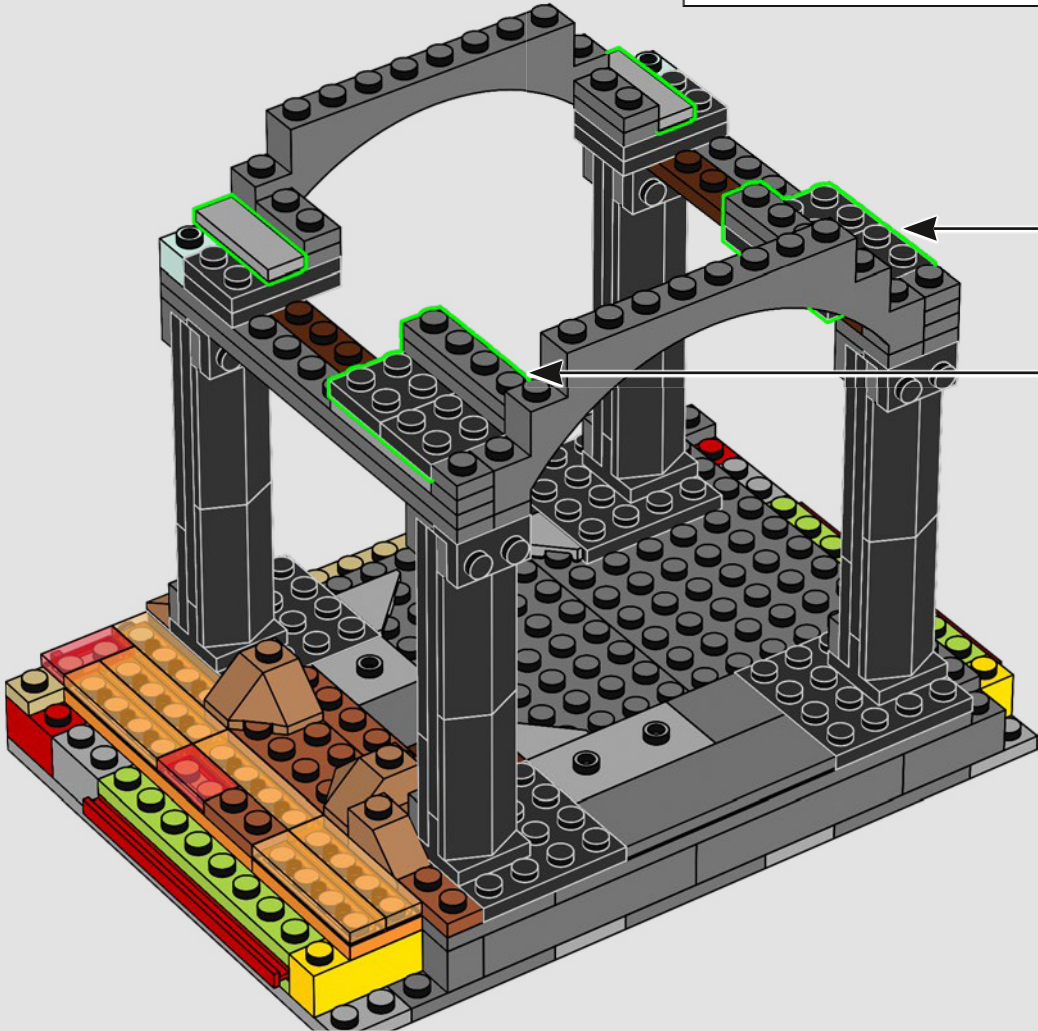
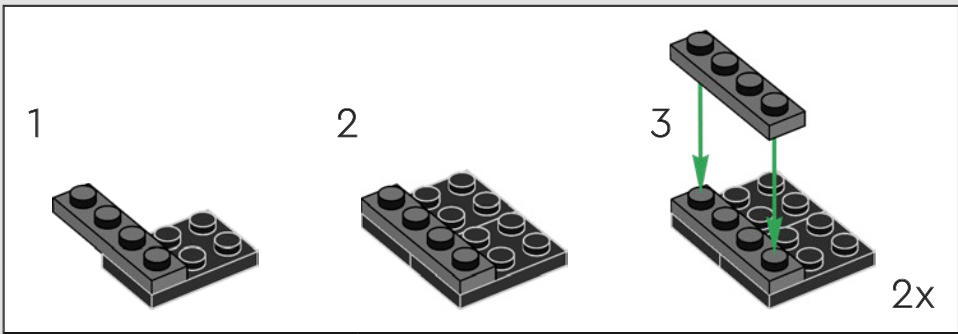

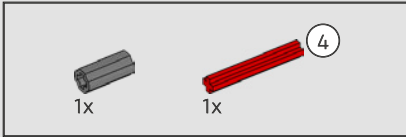
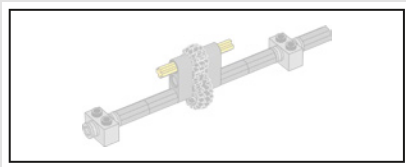

358

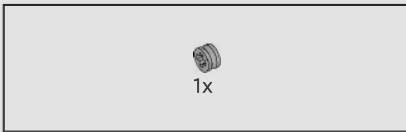
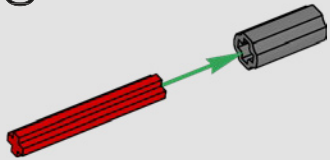

359

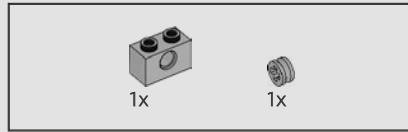
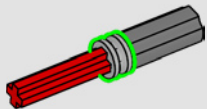

360

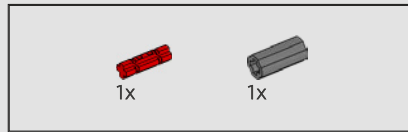
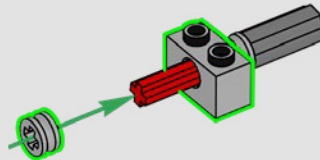

361

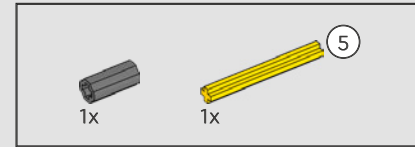
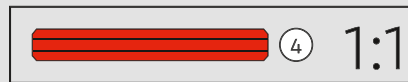
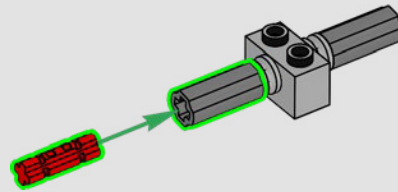

362

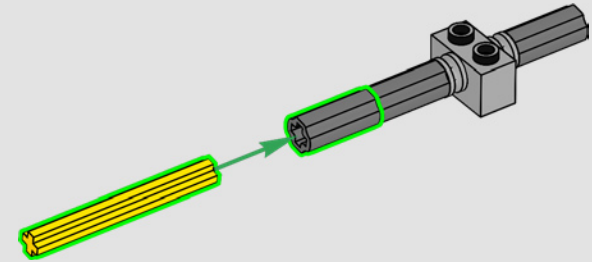

363

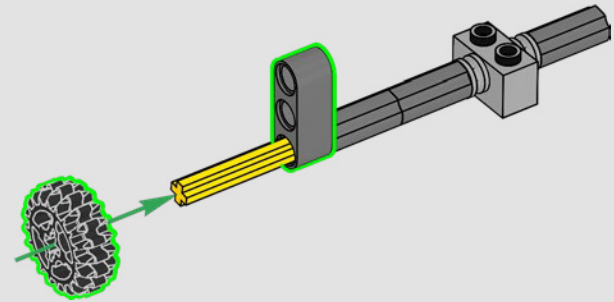

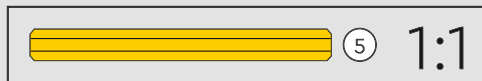
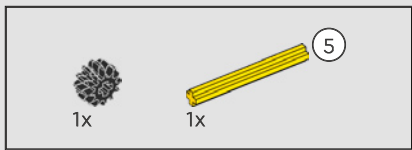

364

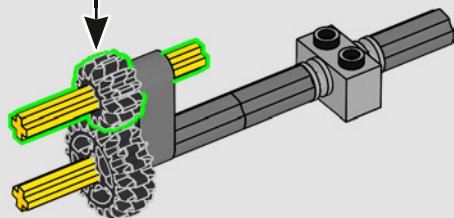
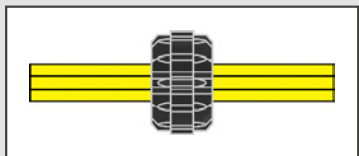

365

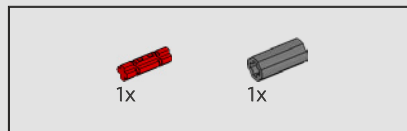
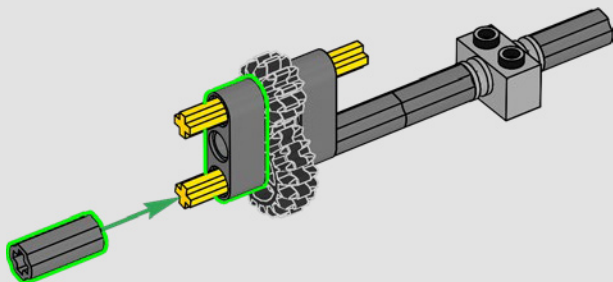

366

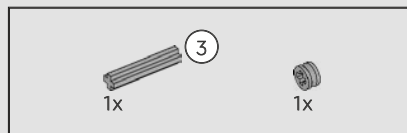
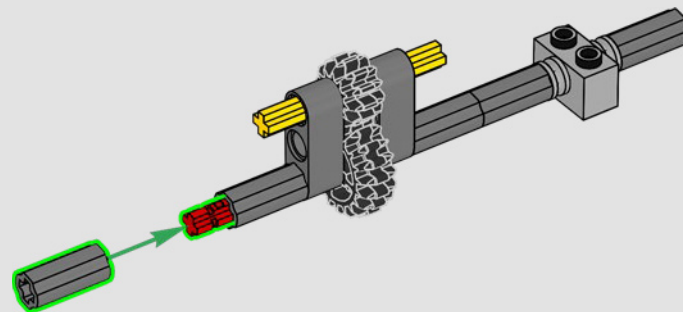

367

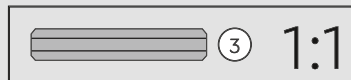
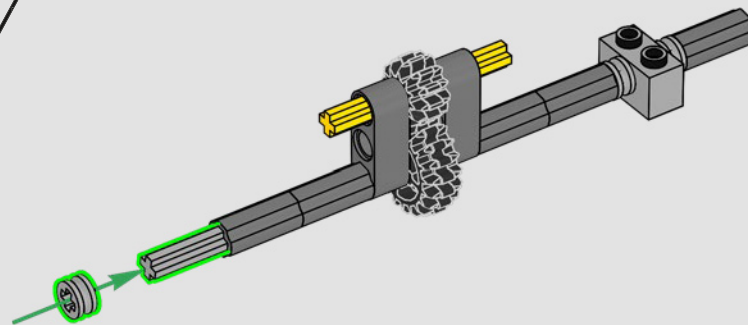

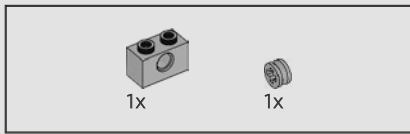

368

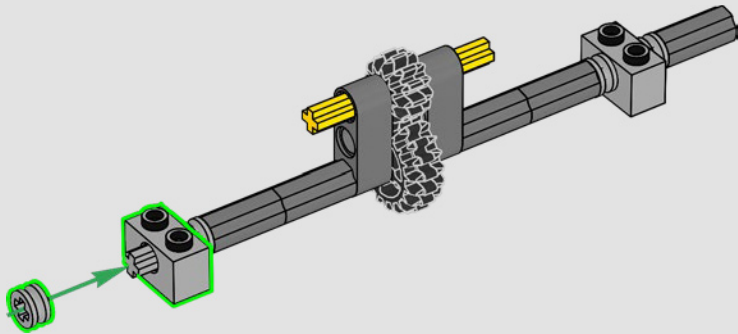

369

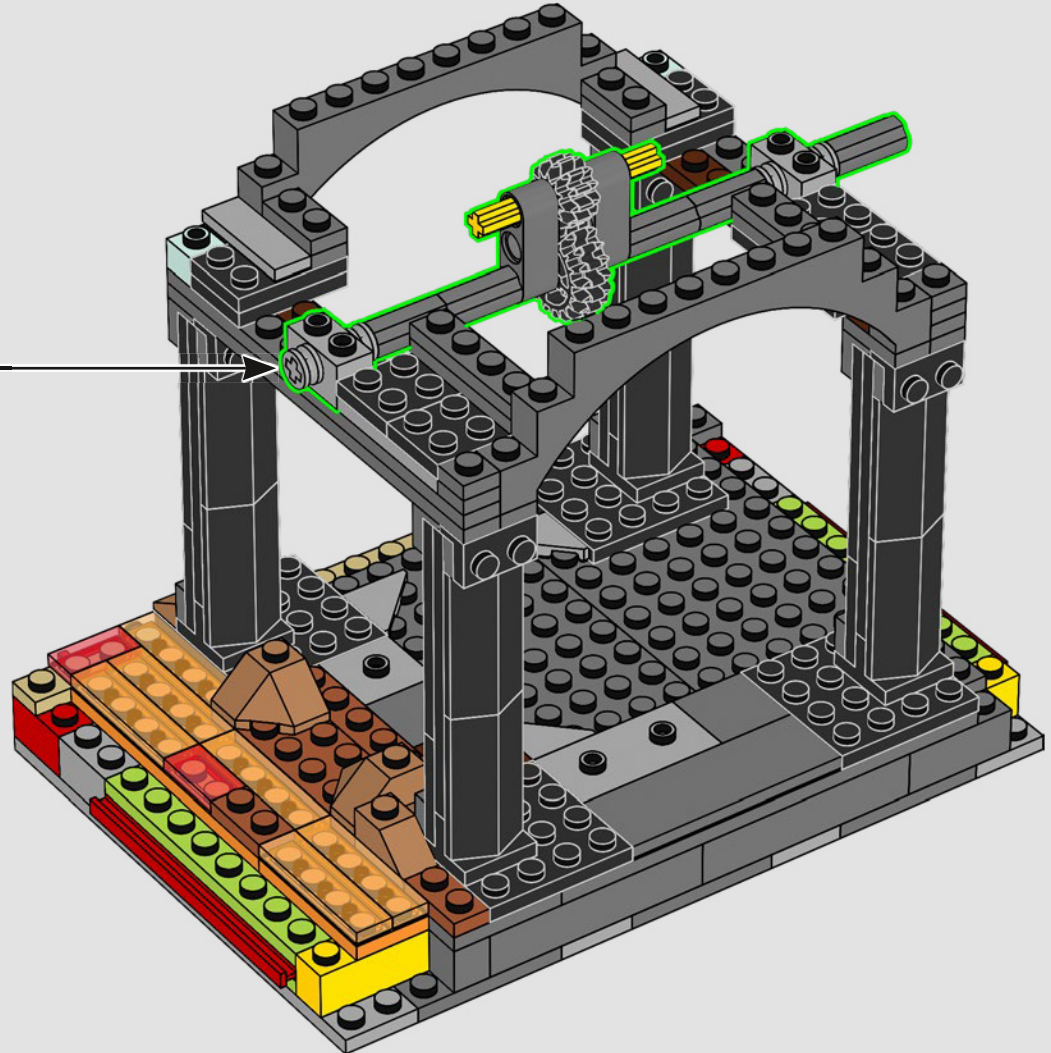

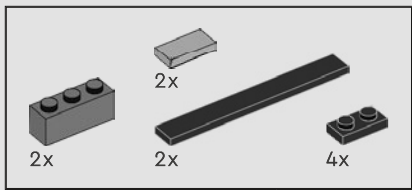

370

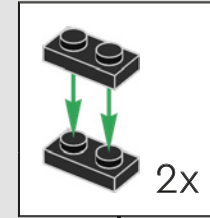
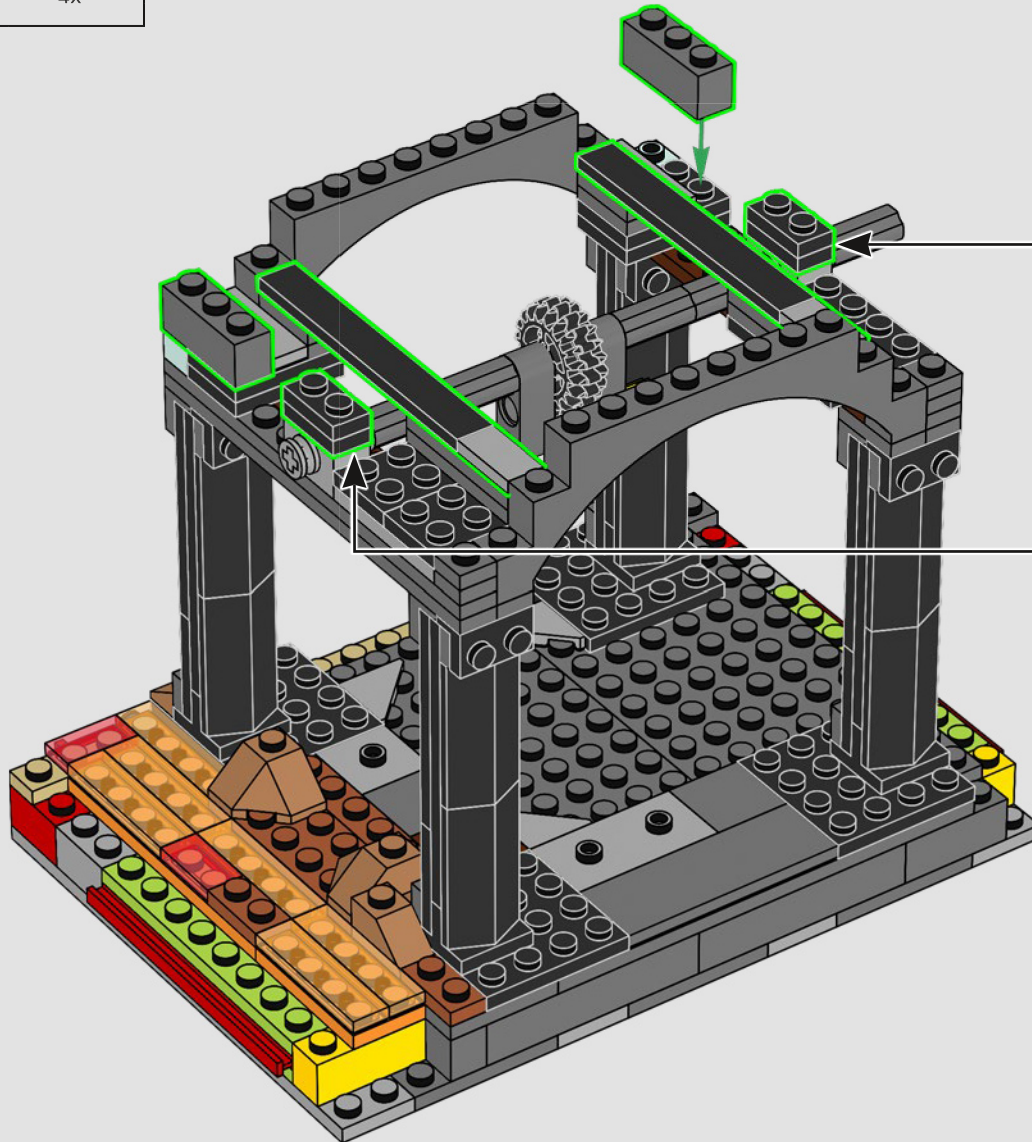

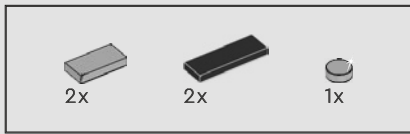

371

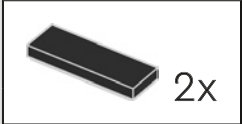
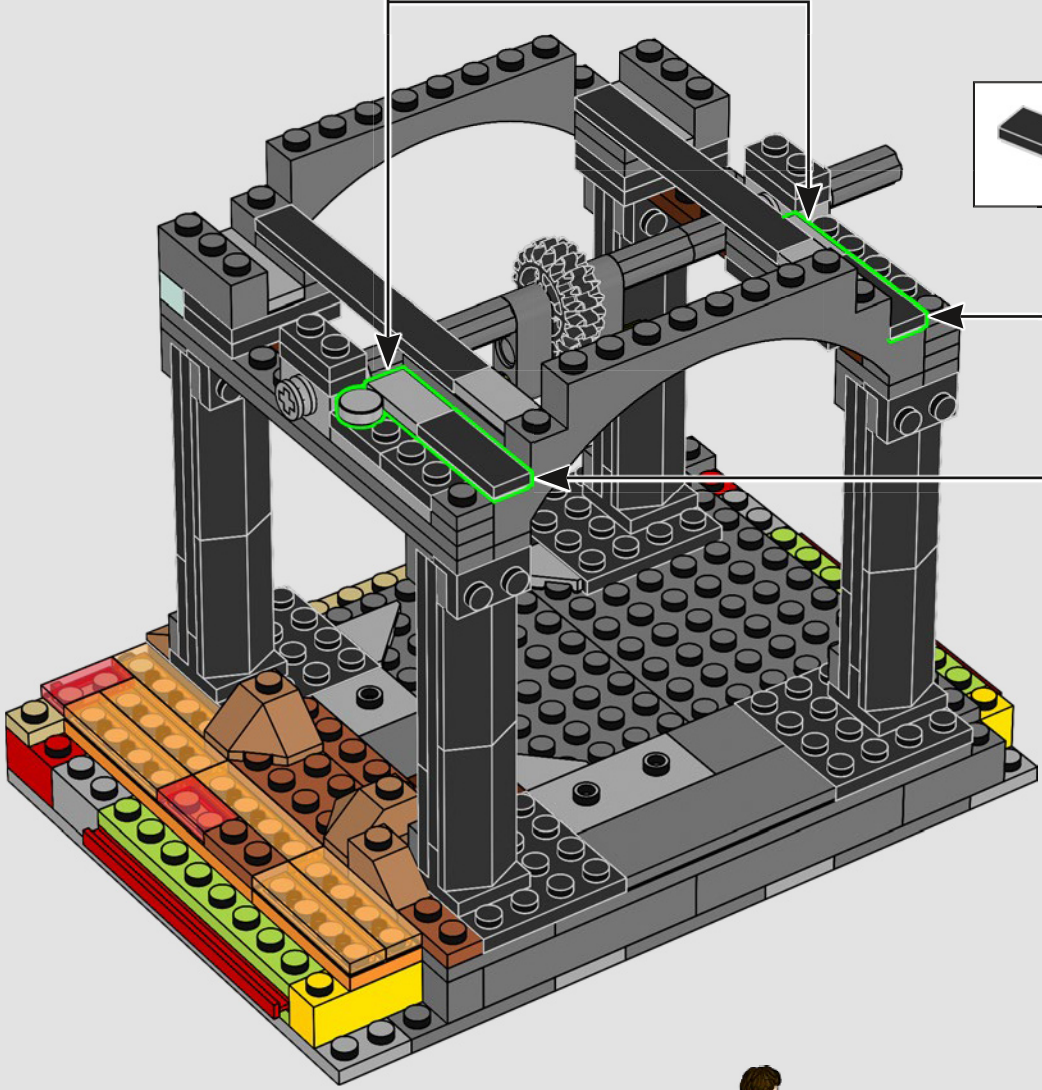
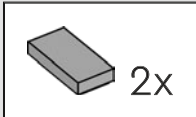

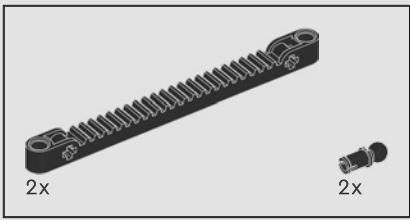

372

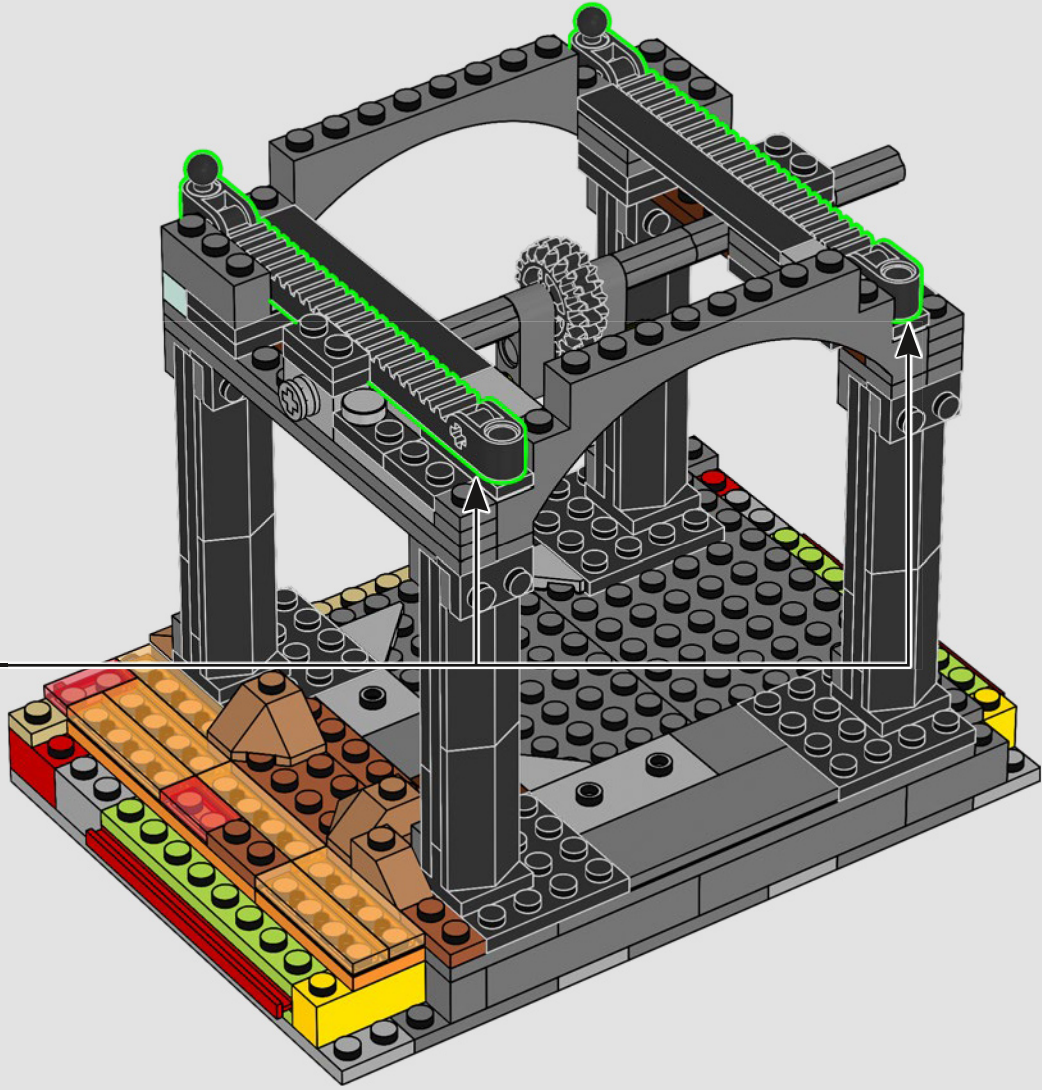
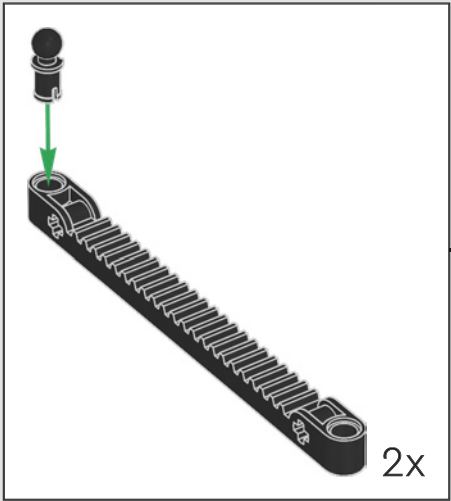

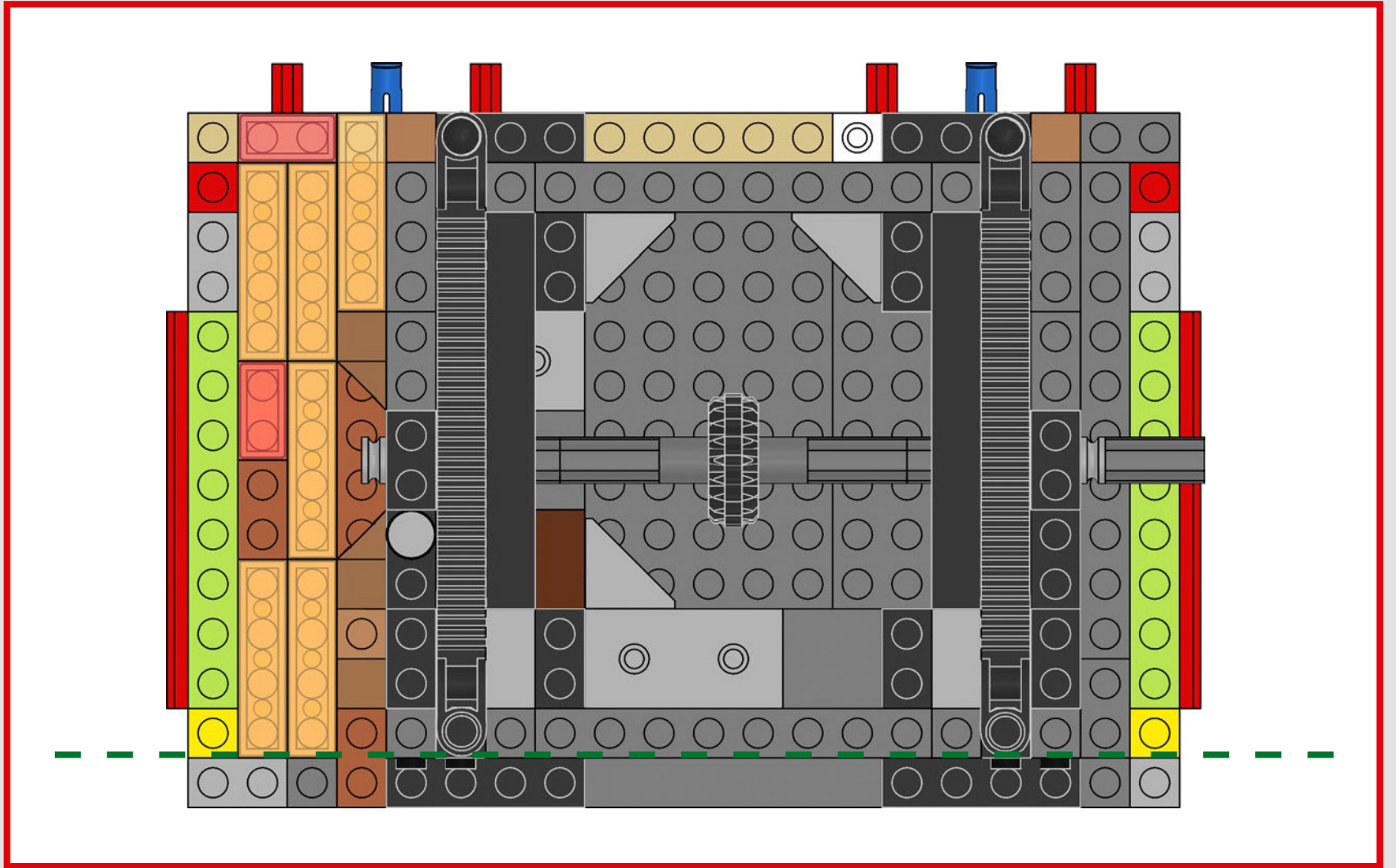



373

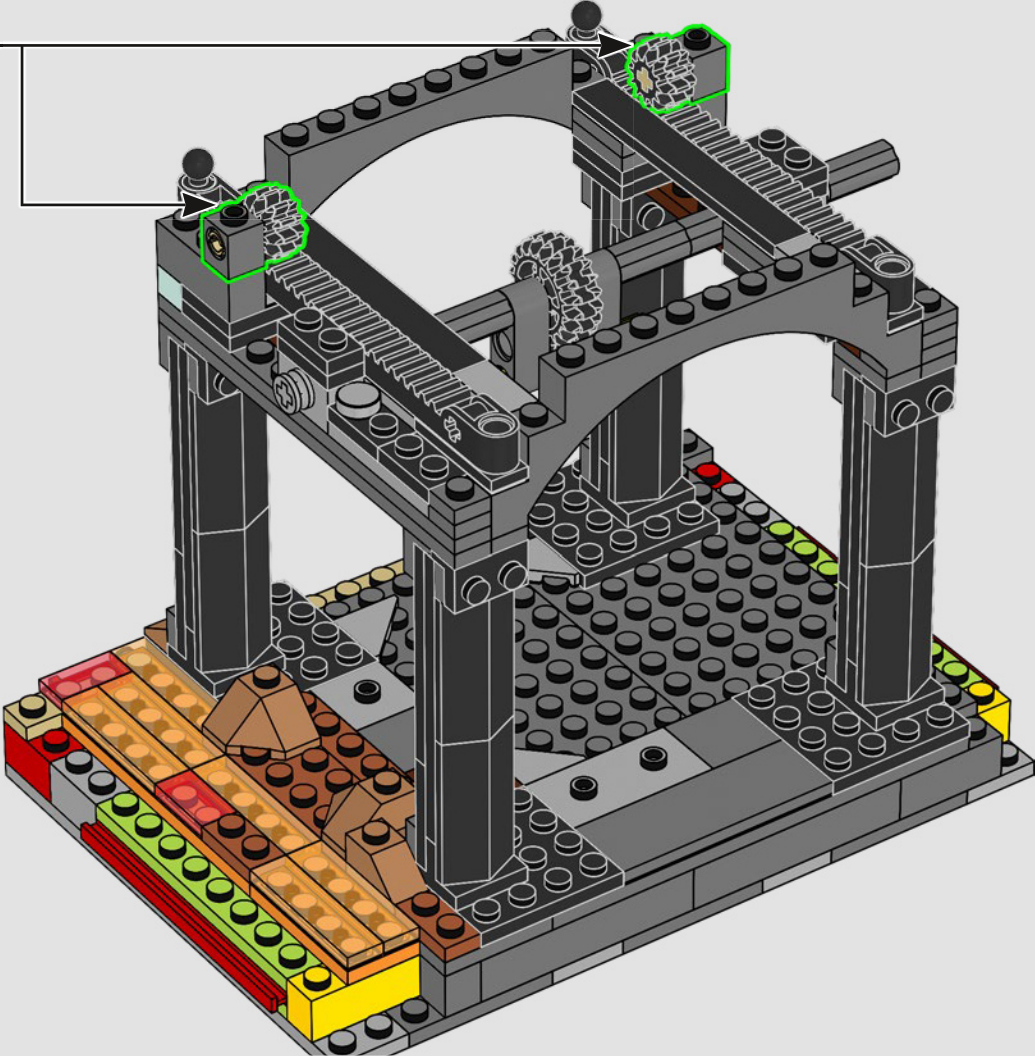
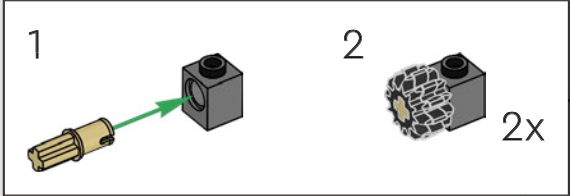

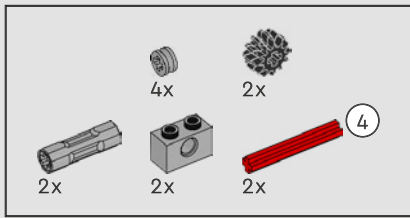

374

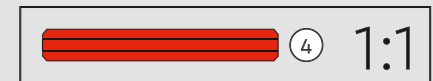
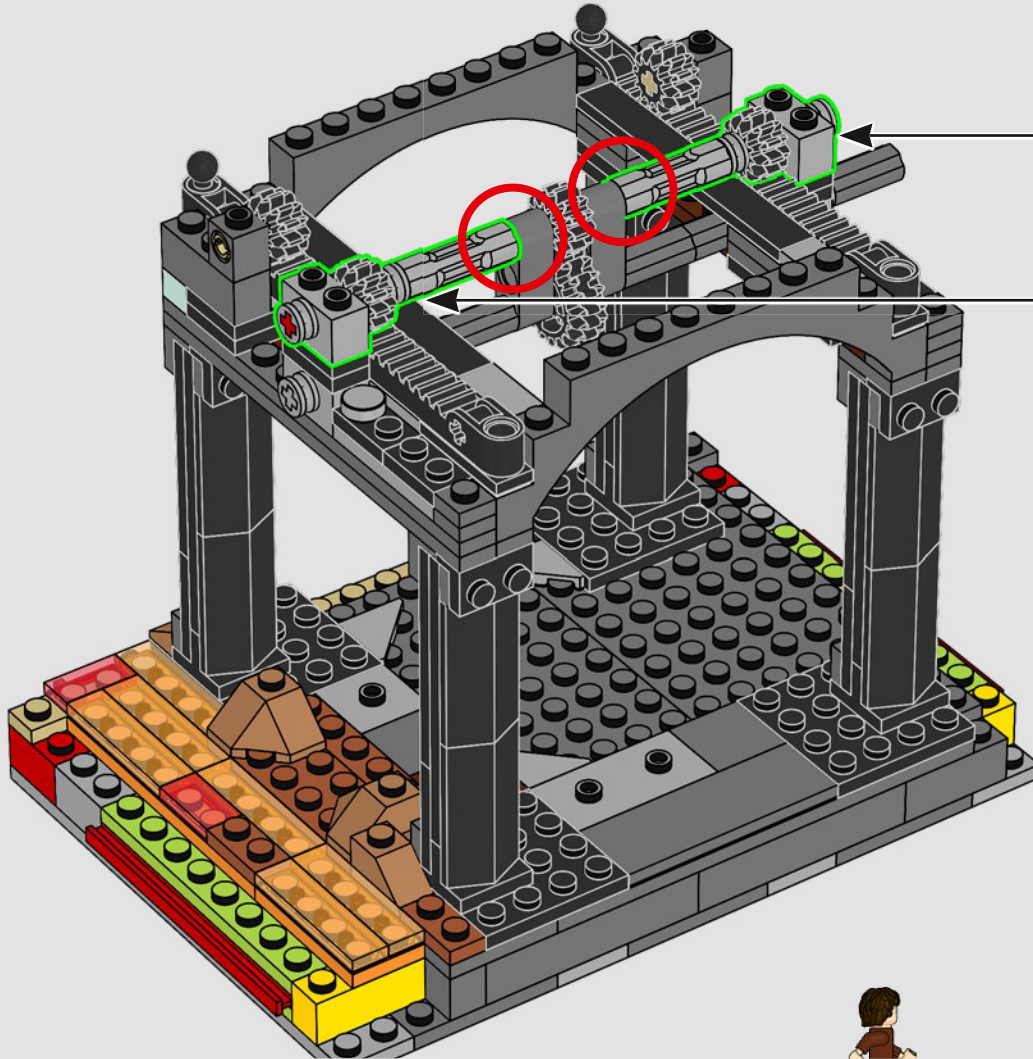
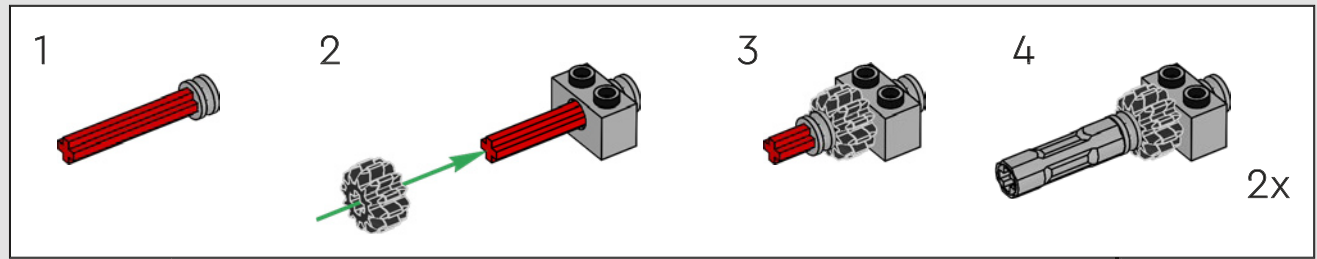

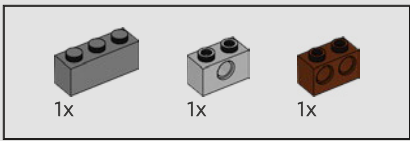

375

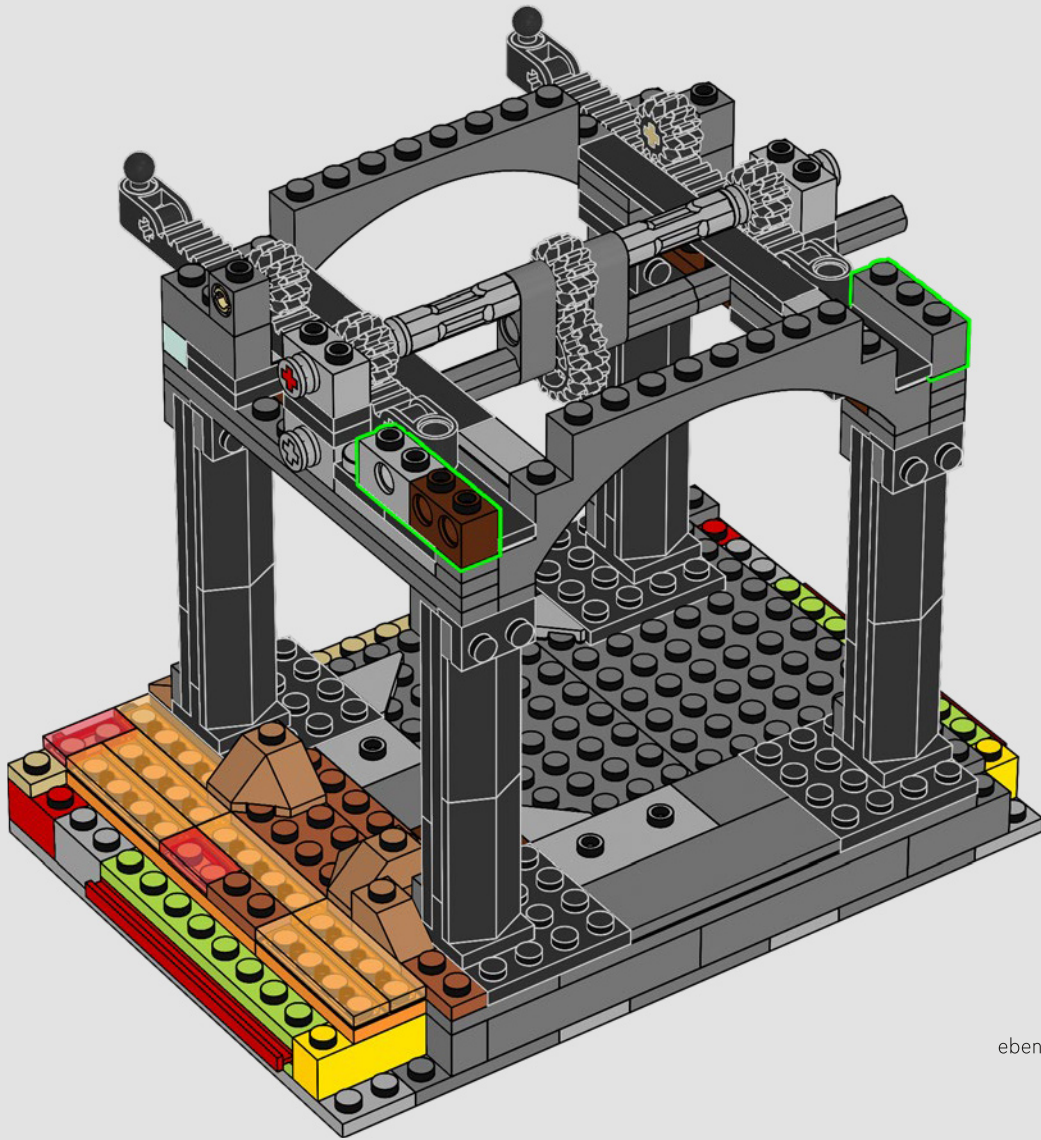

 Zum Öffnen der Haupttore zur Festung wird ein ebenso einfacher wie effektiver Mechanismus benutzt.

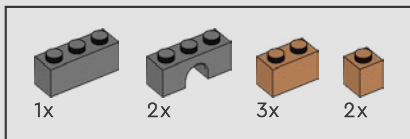

376

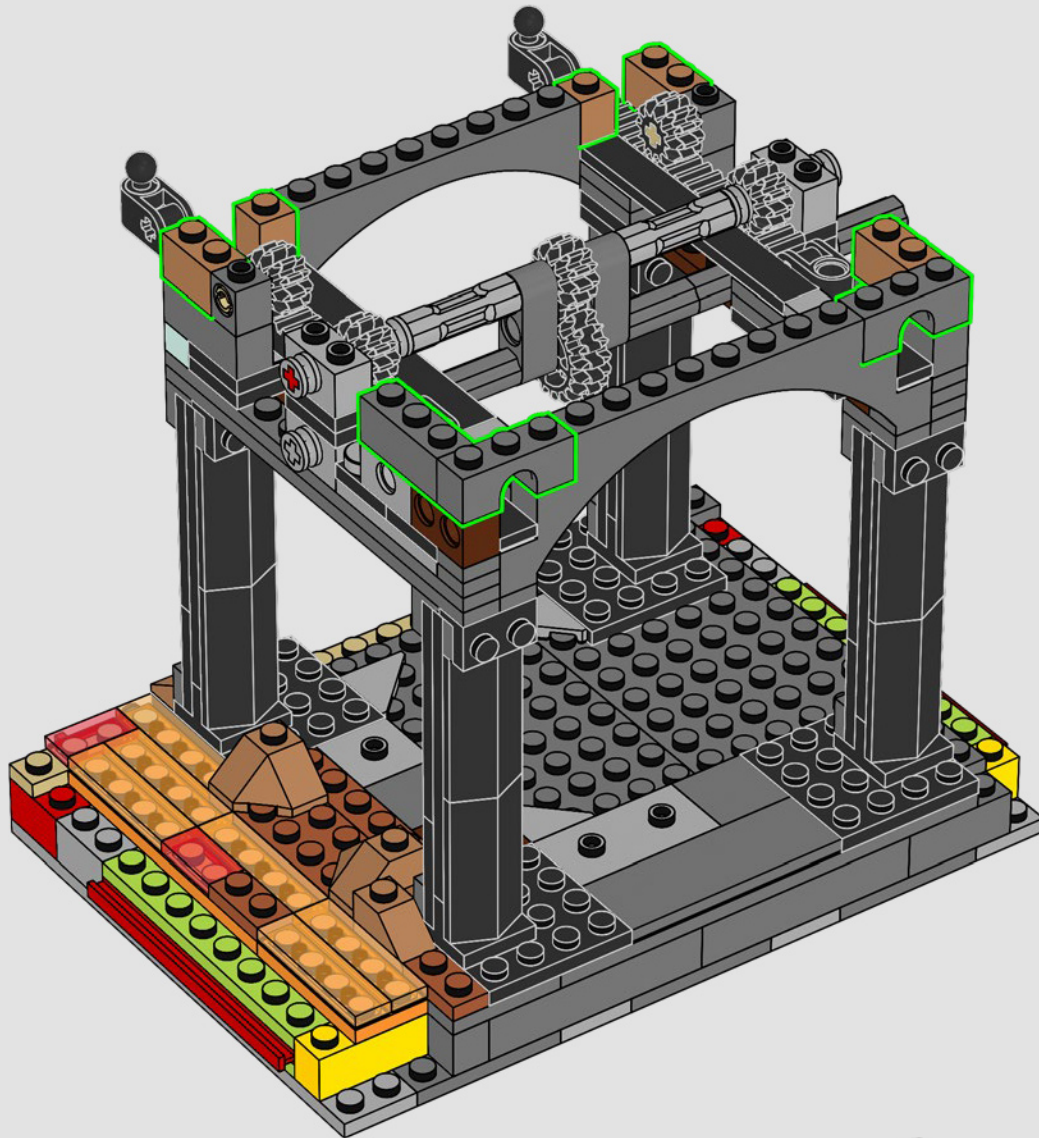

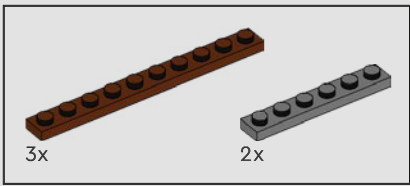

377

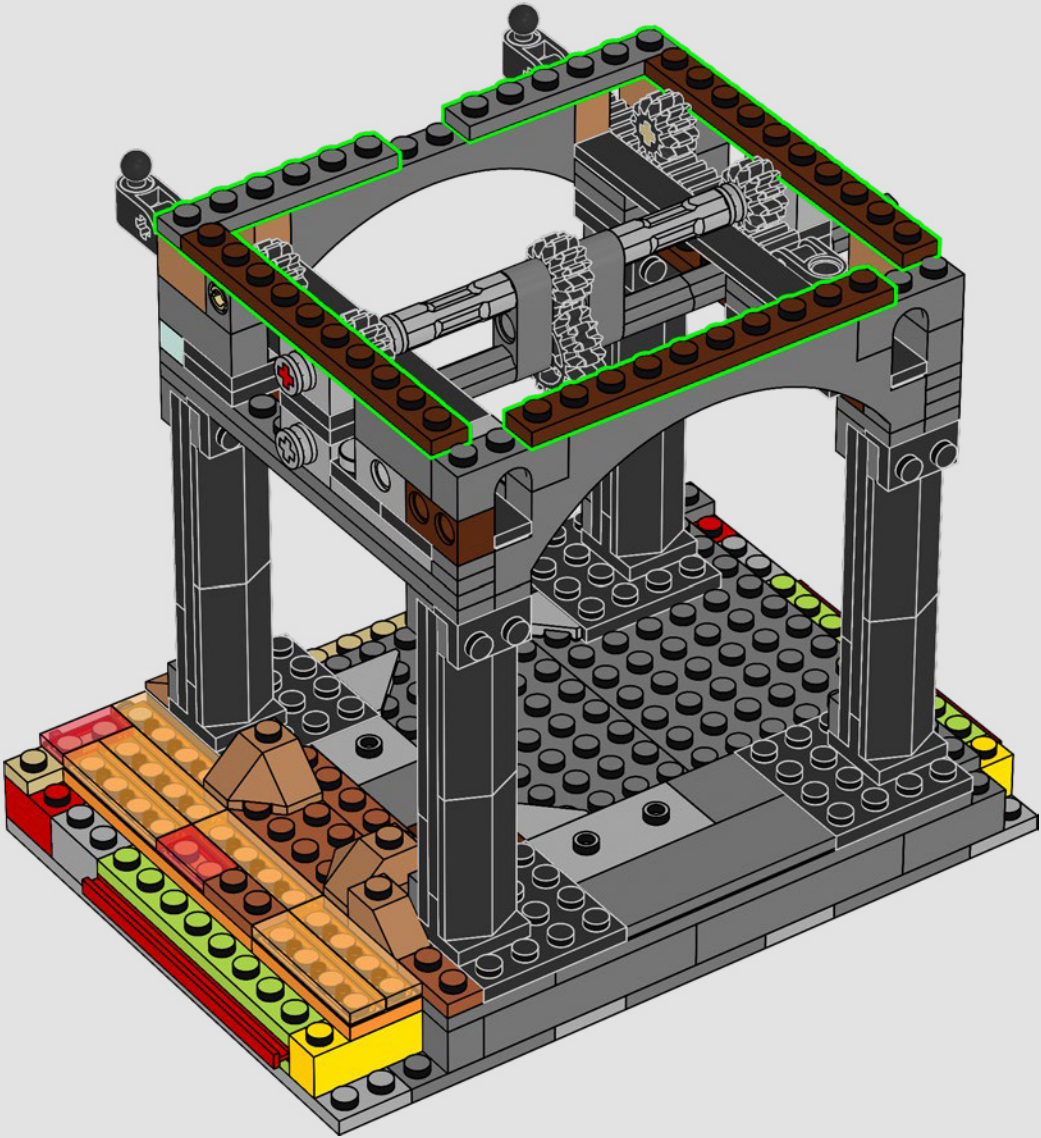

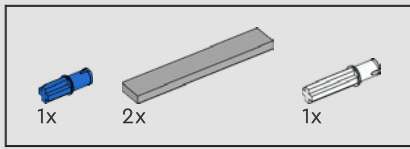

378

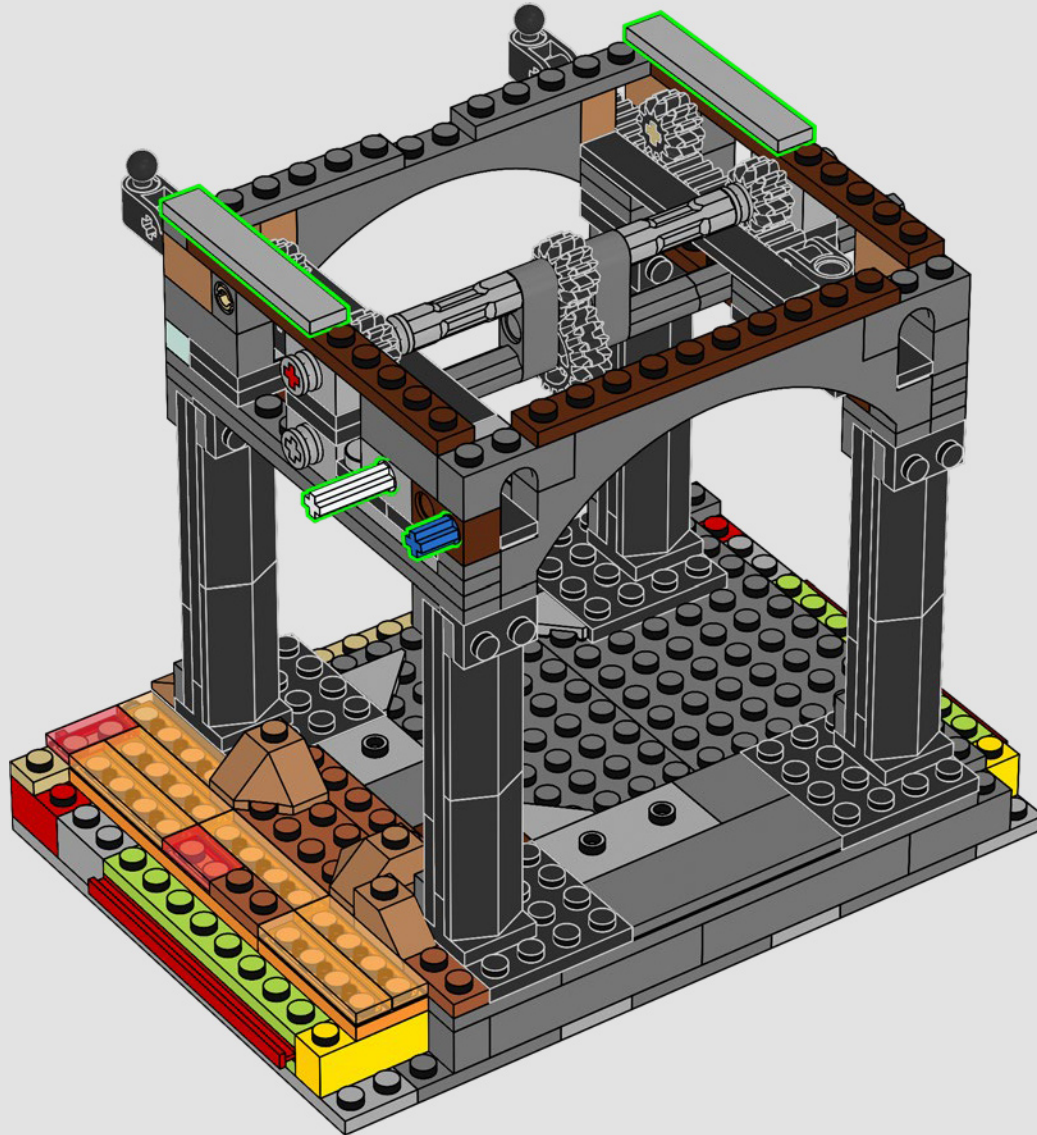



2x

379

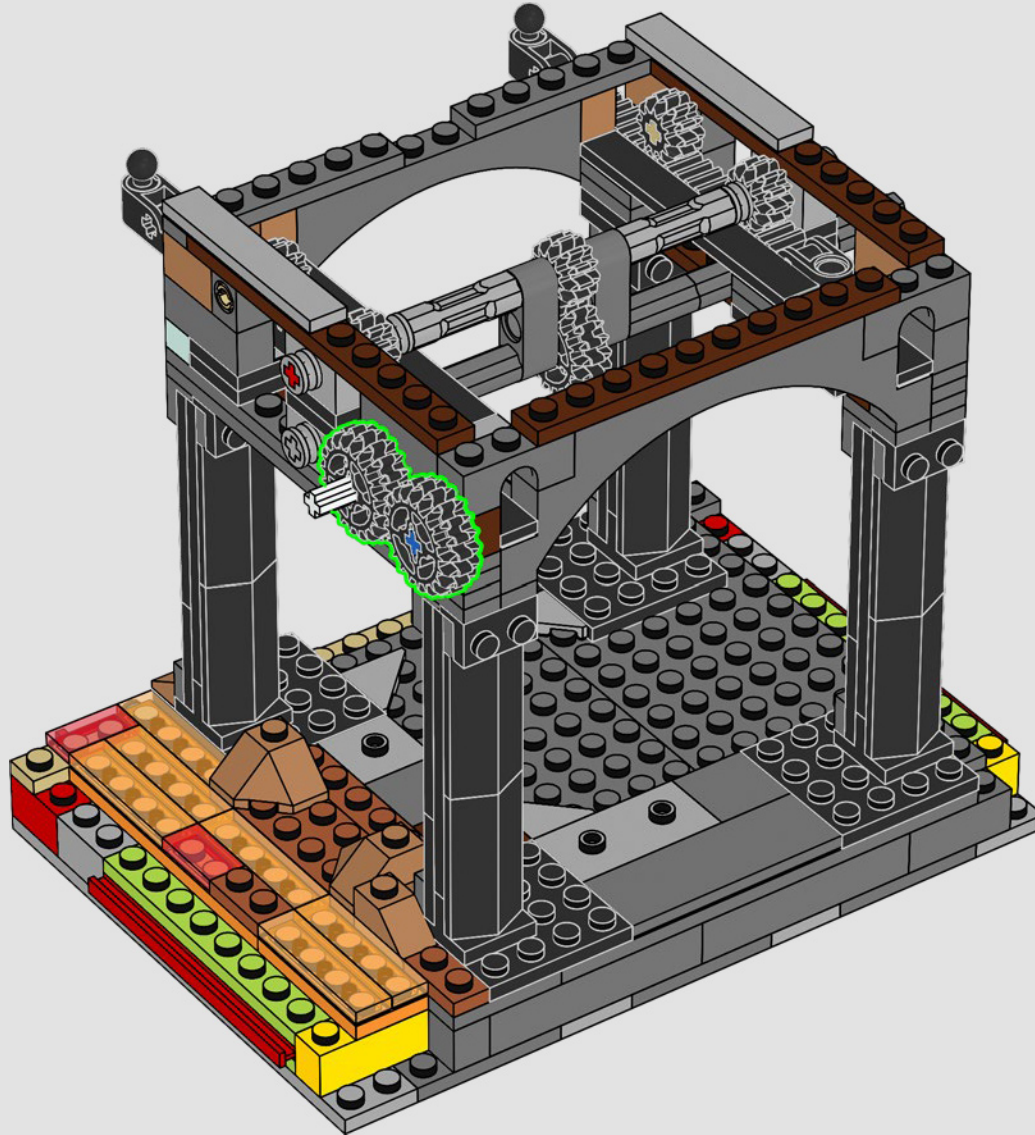

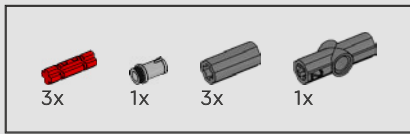

380

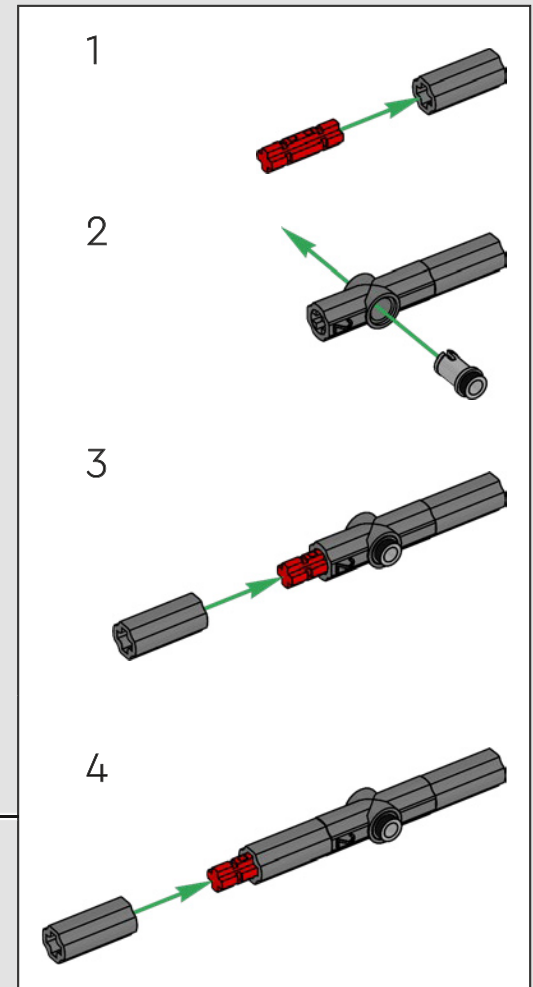
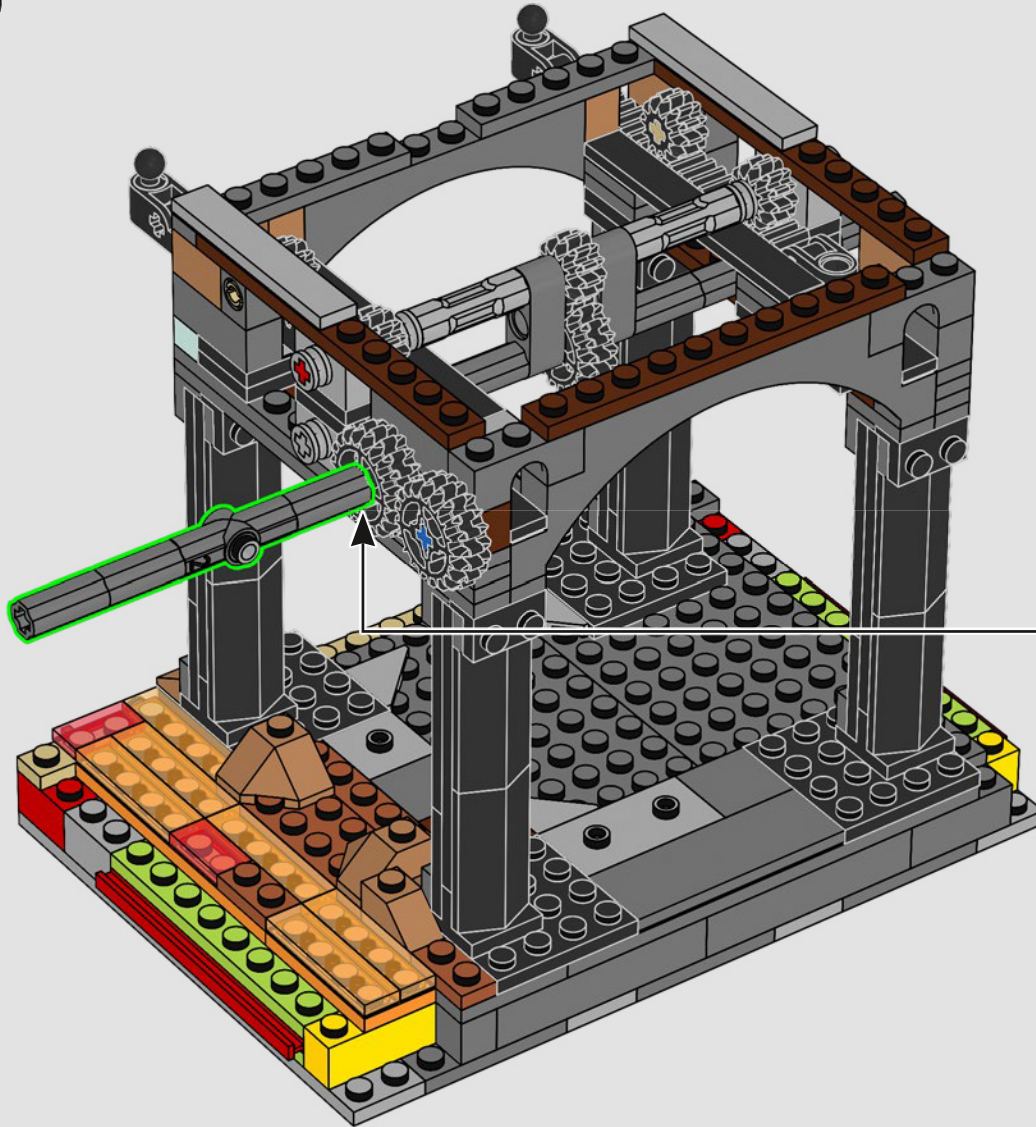

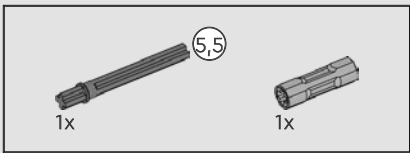

381

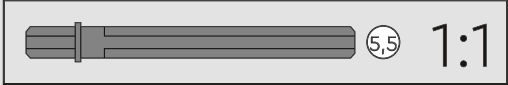
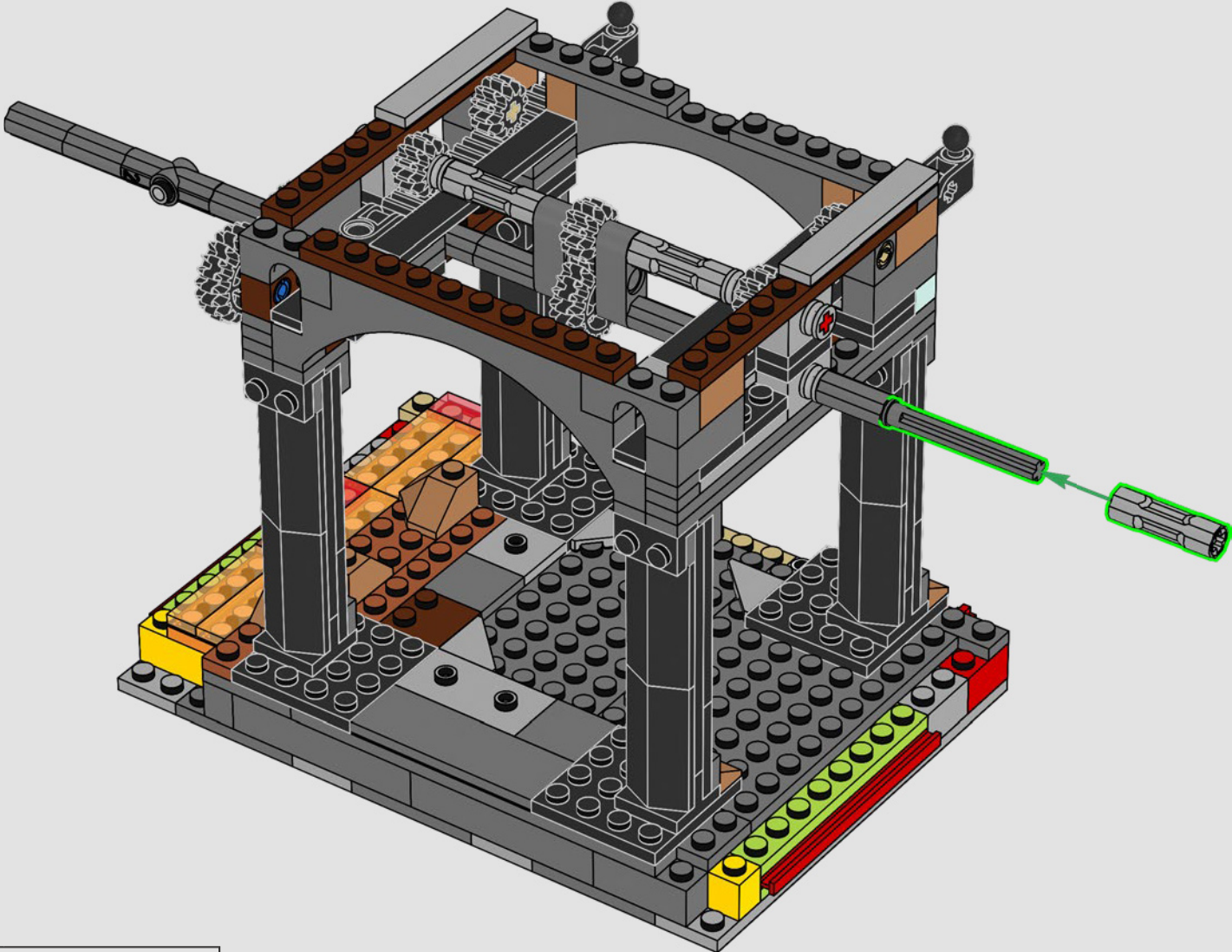

382

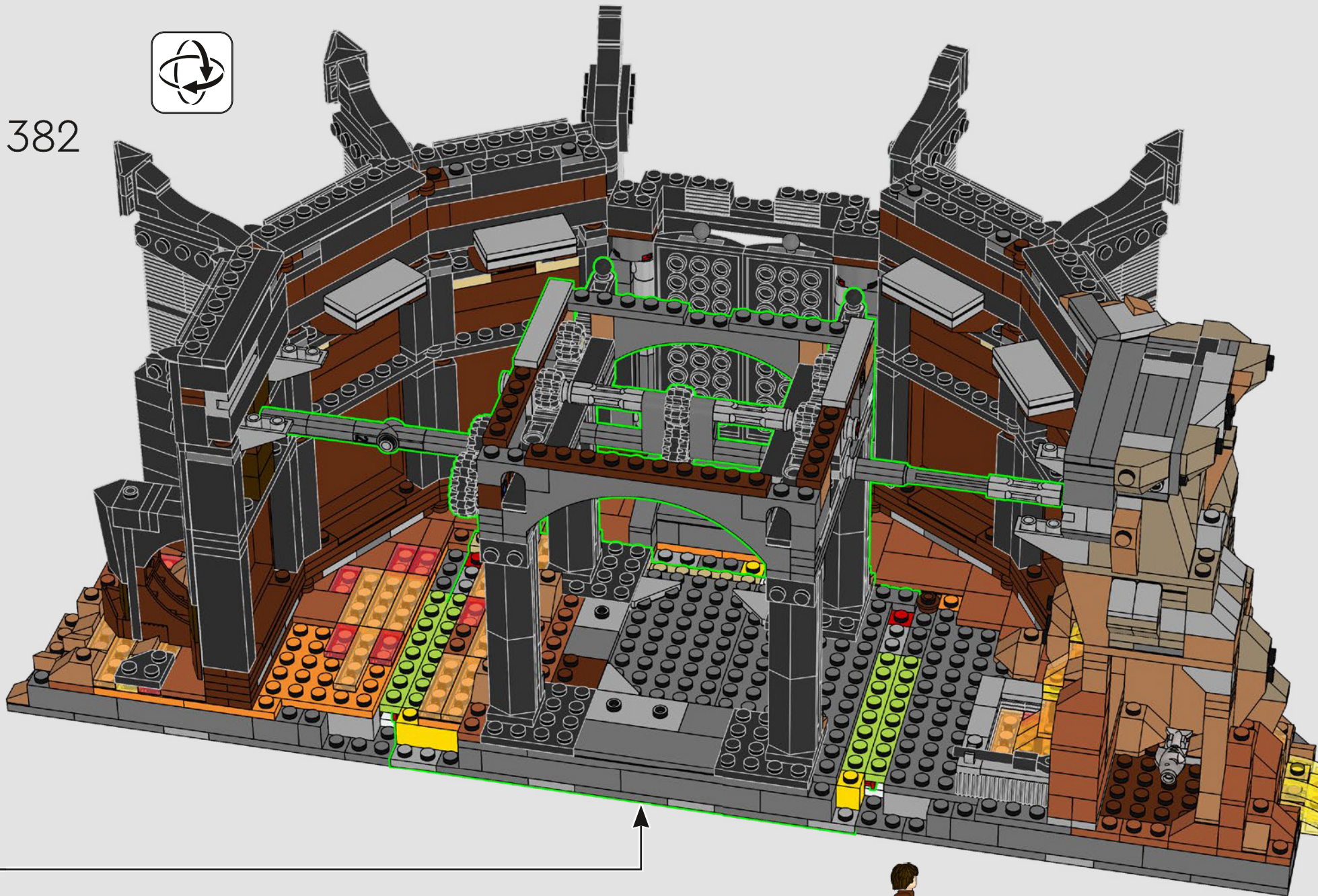

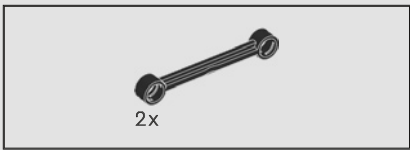

383

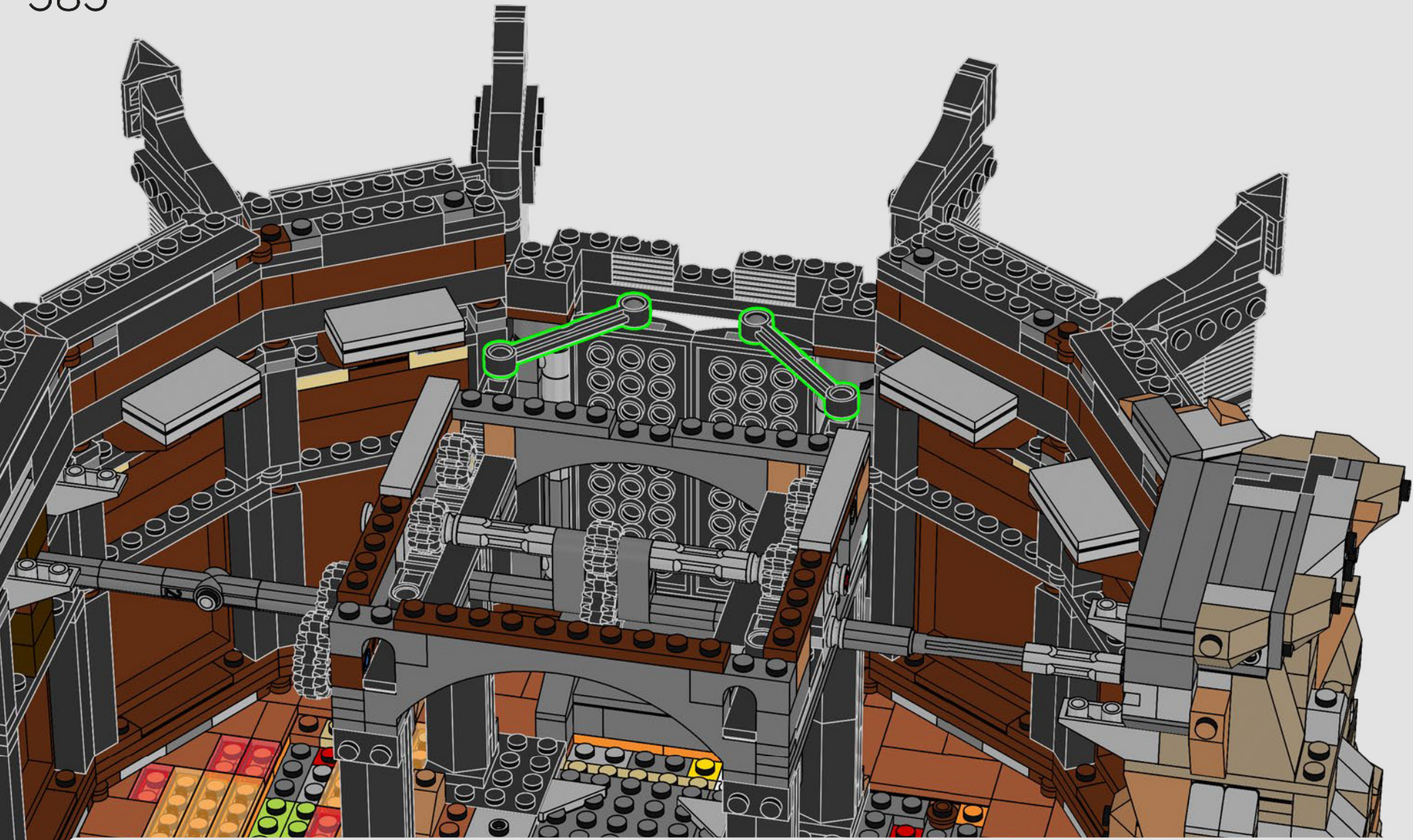



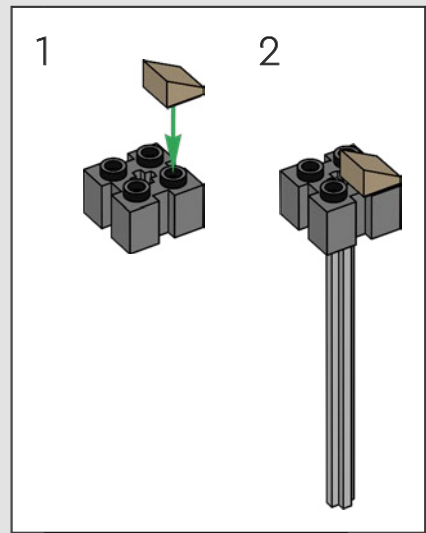
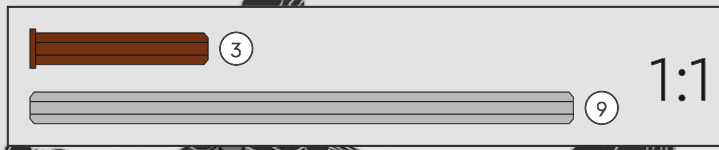
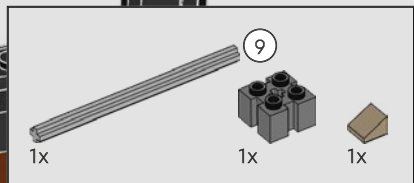

384

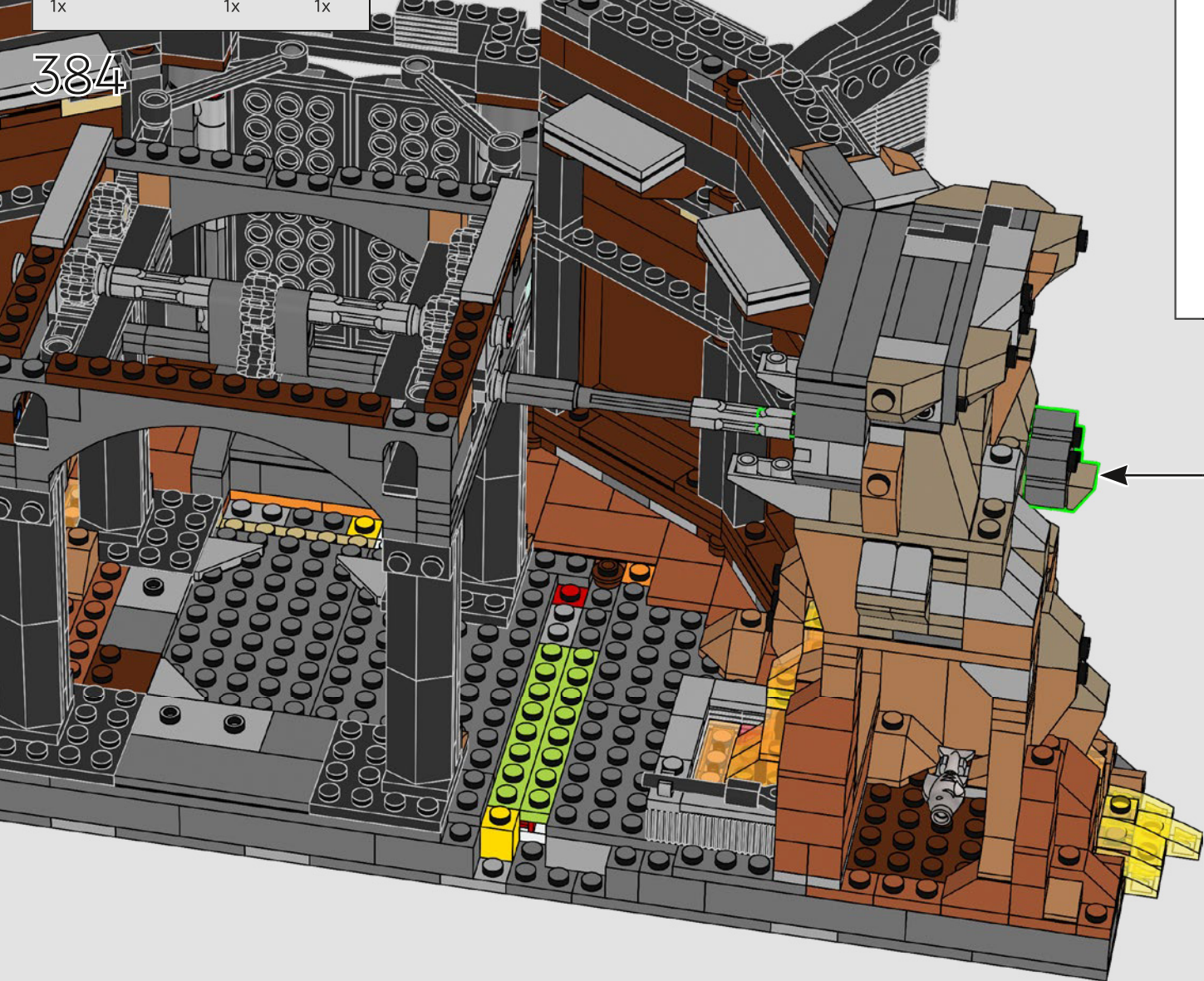

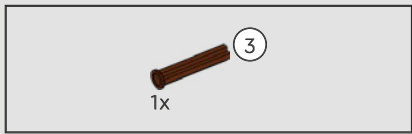

Man kann die Haupttore öffnen, indem man an diesem Knauf dreht, der als Fels getarnt ist.

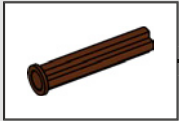

385

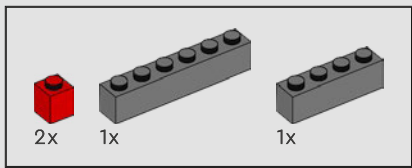



386

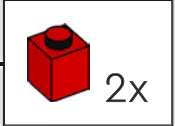
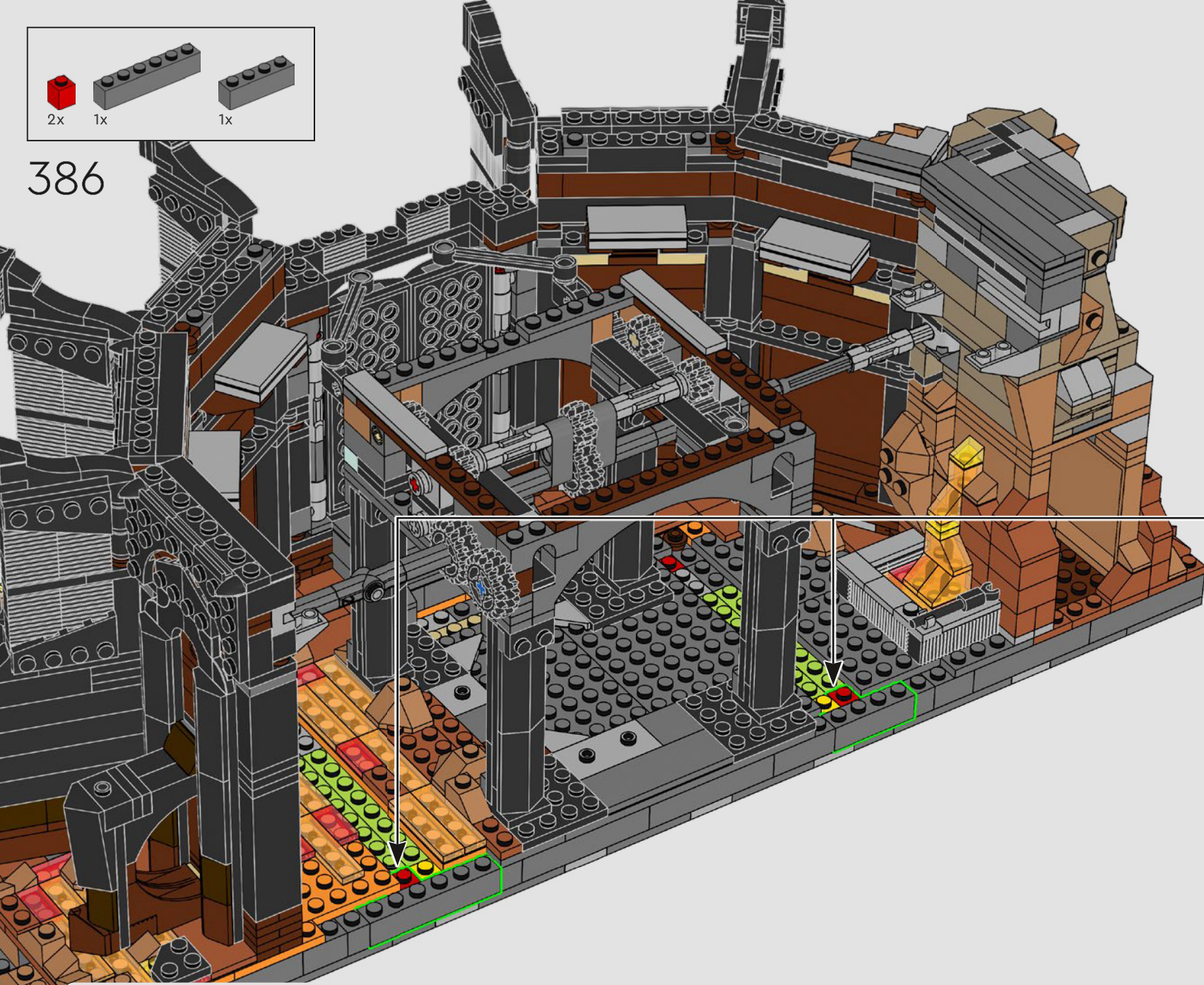

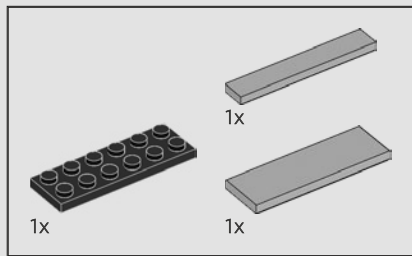

387

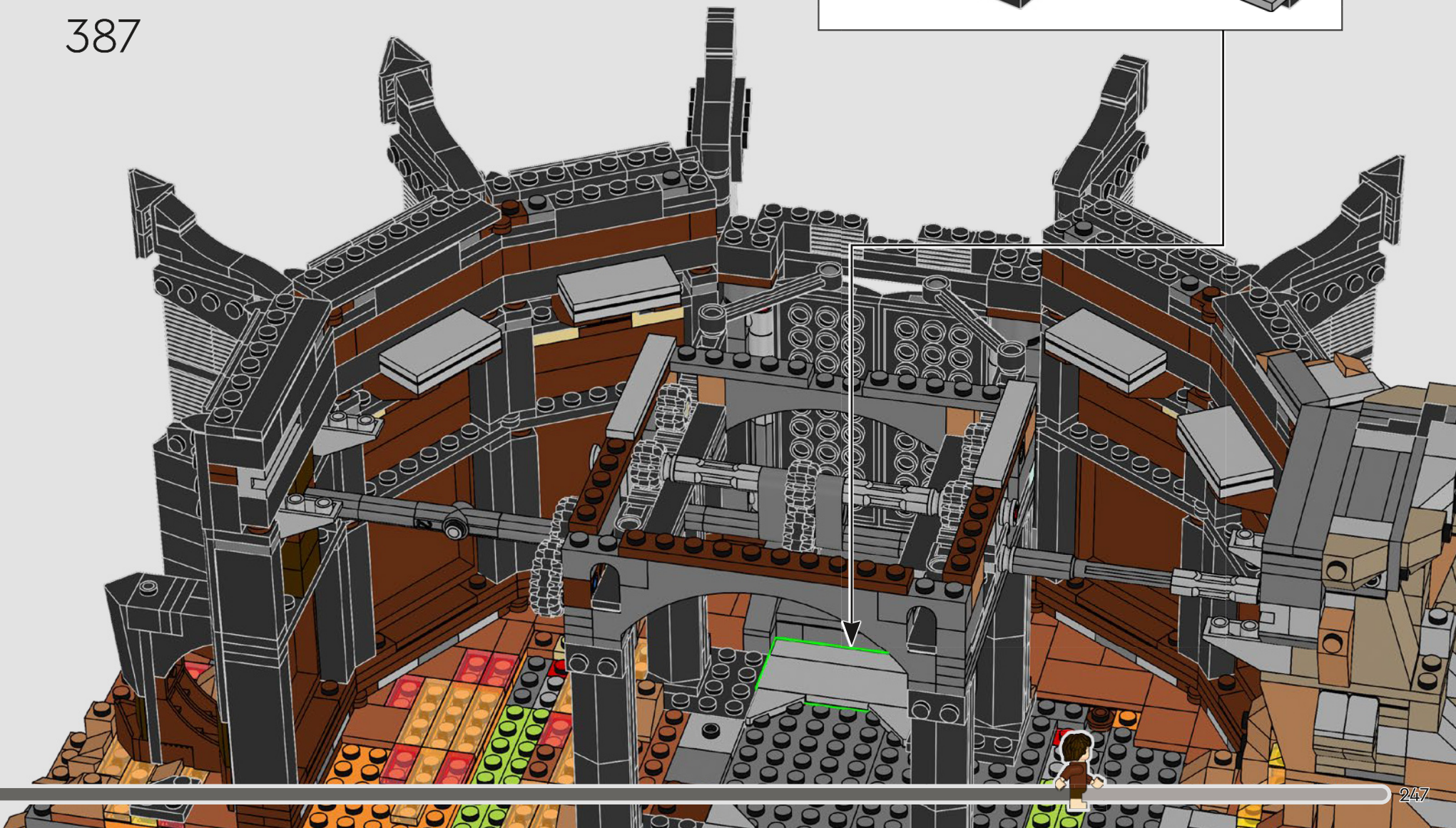
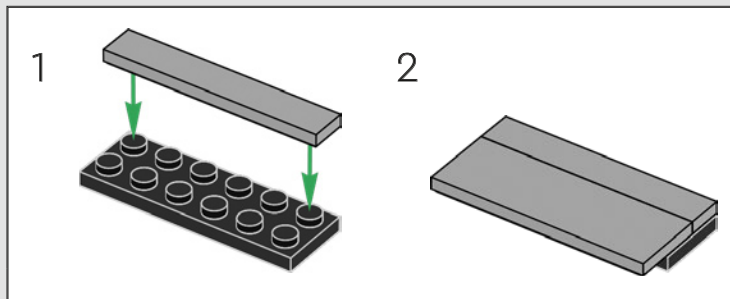

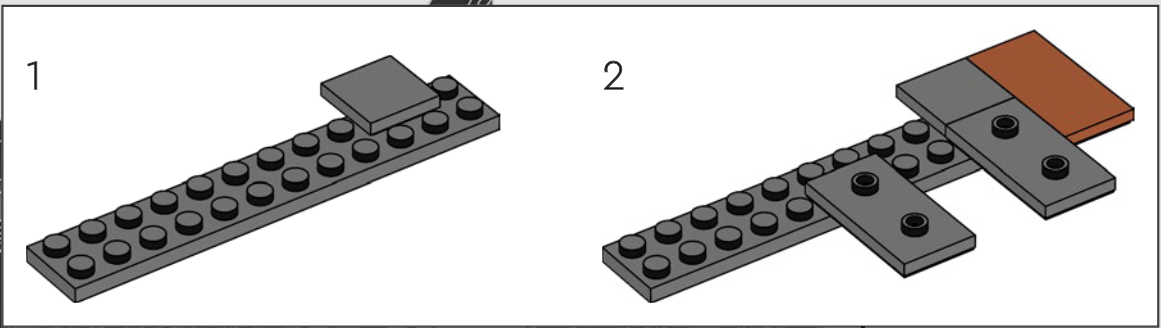
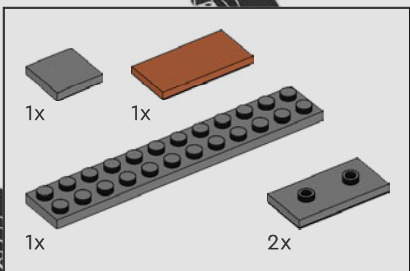

388

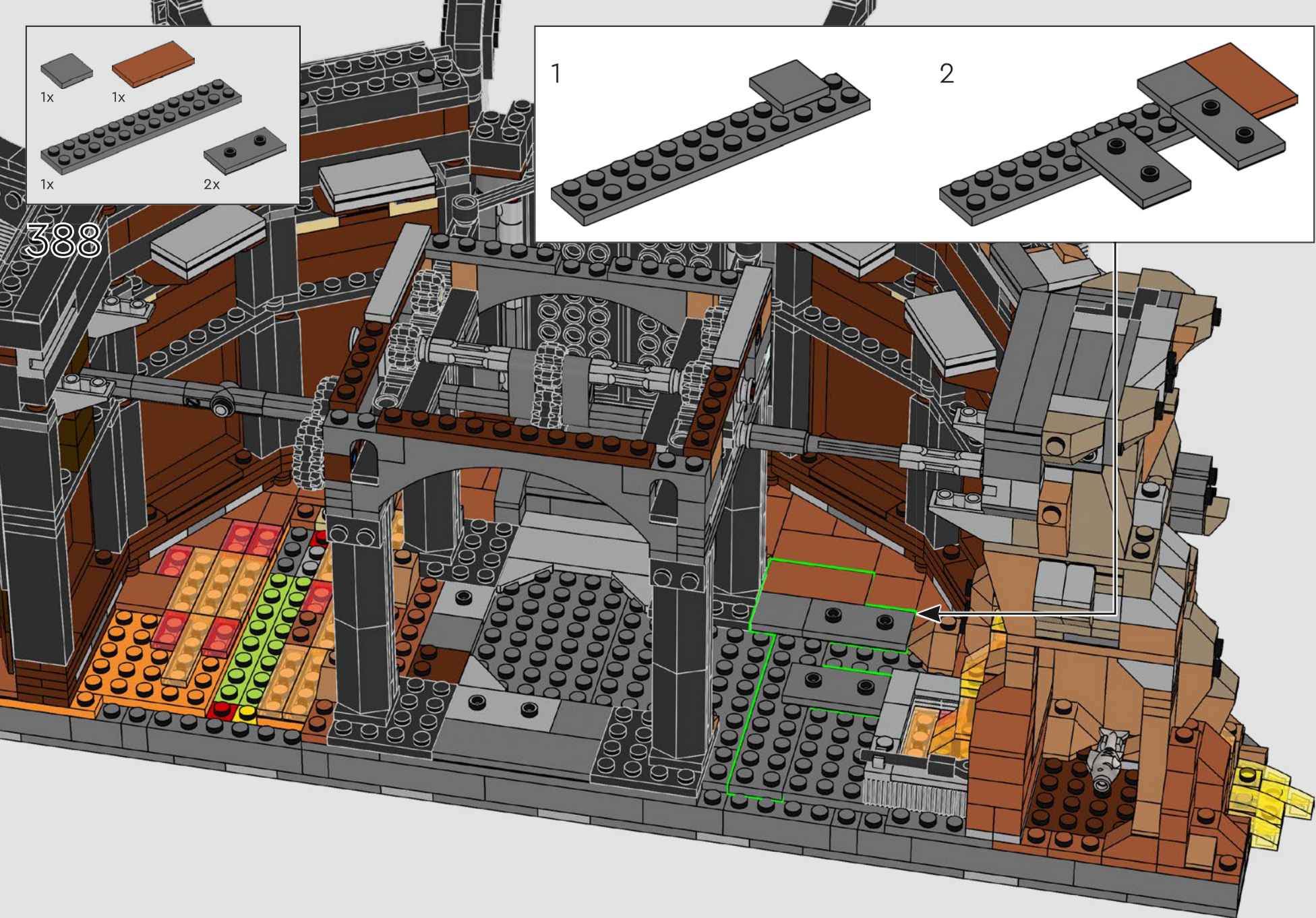

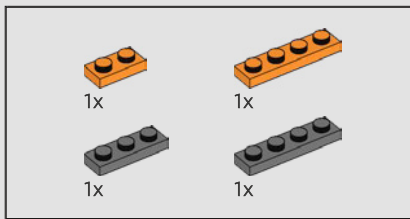

389

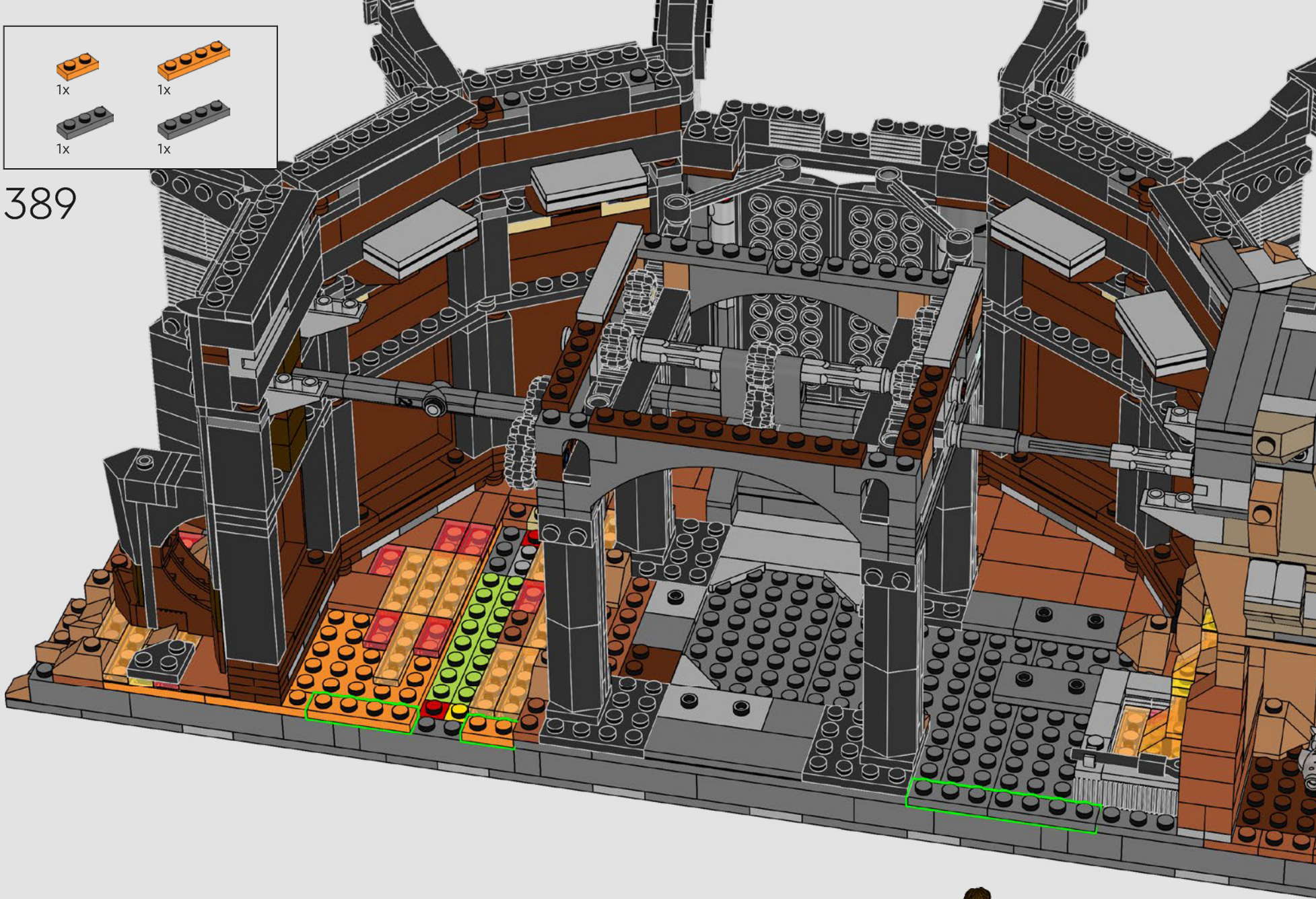

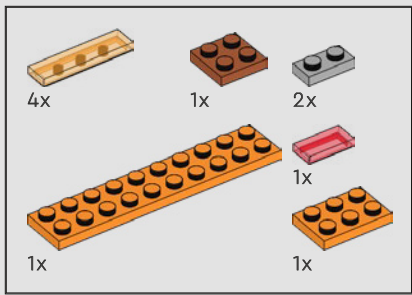

390

1

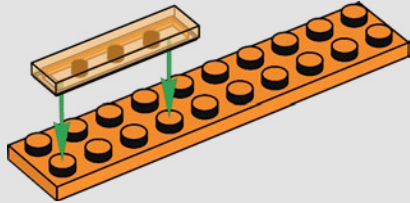

2

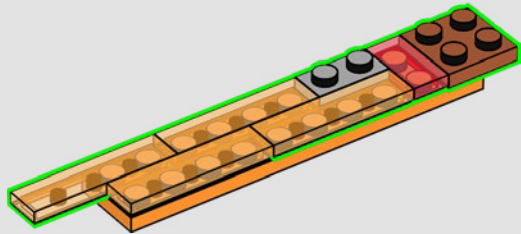

3

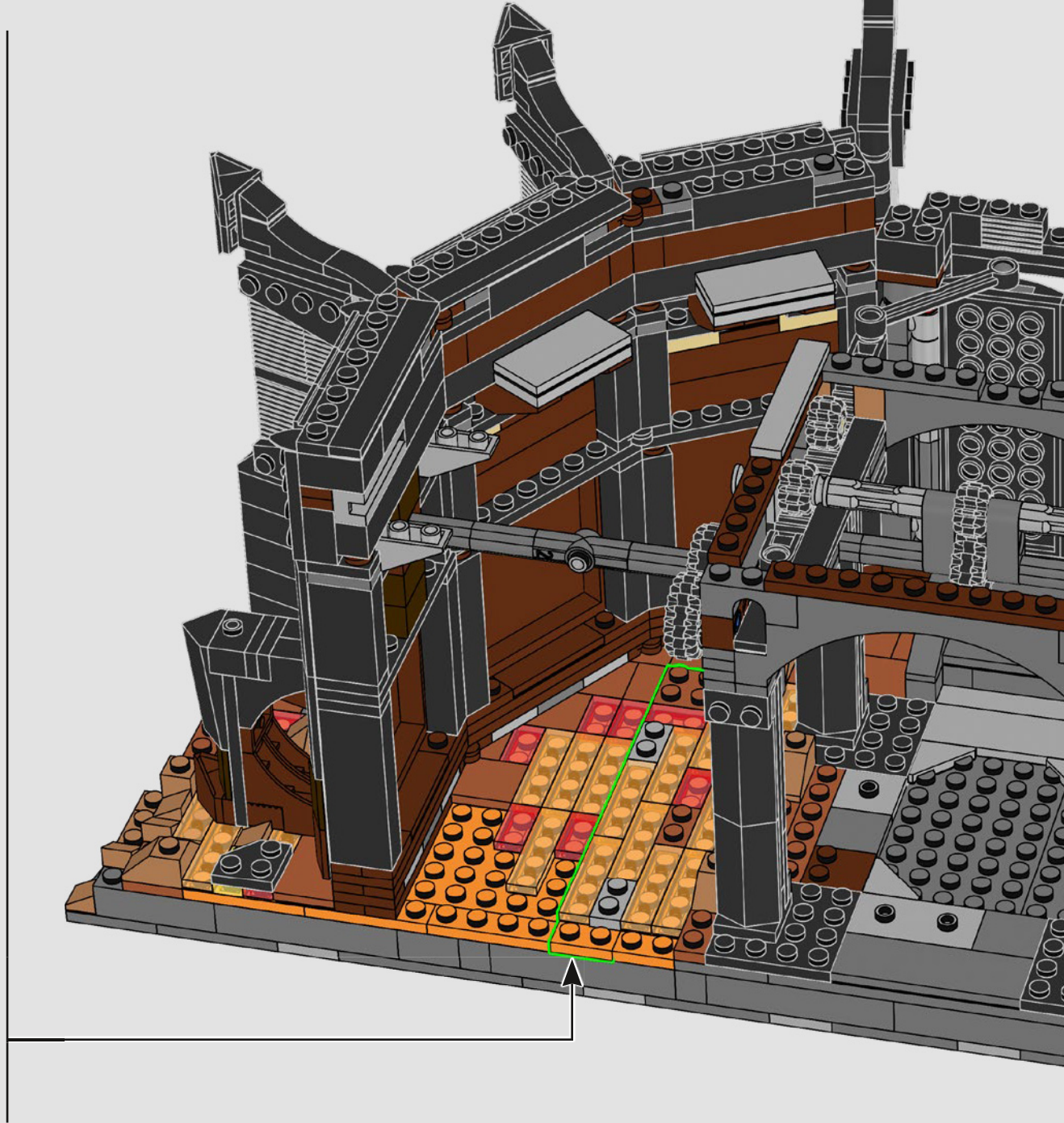
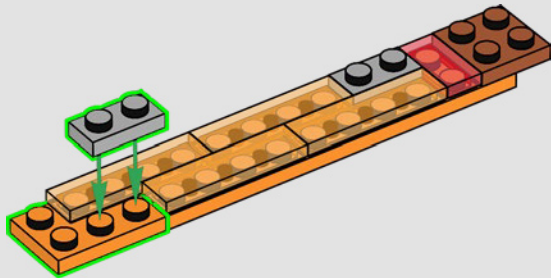

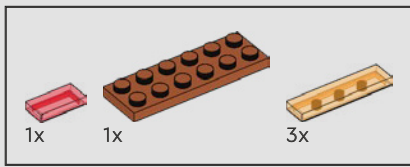

391

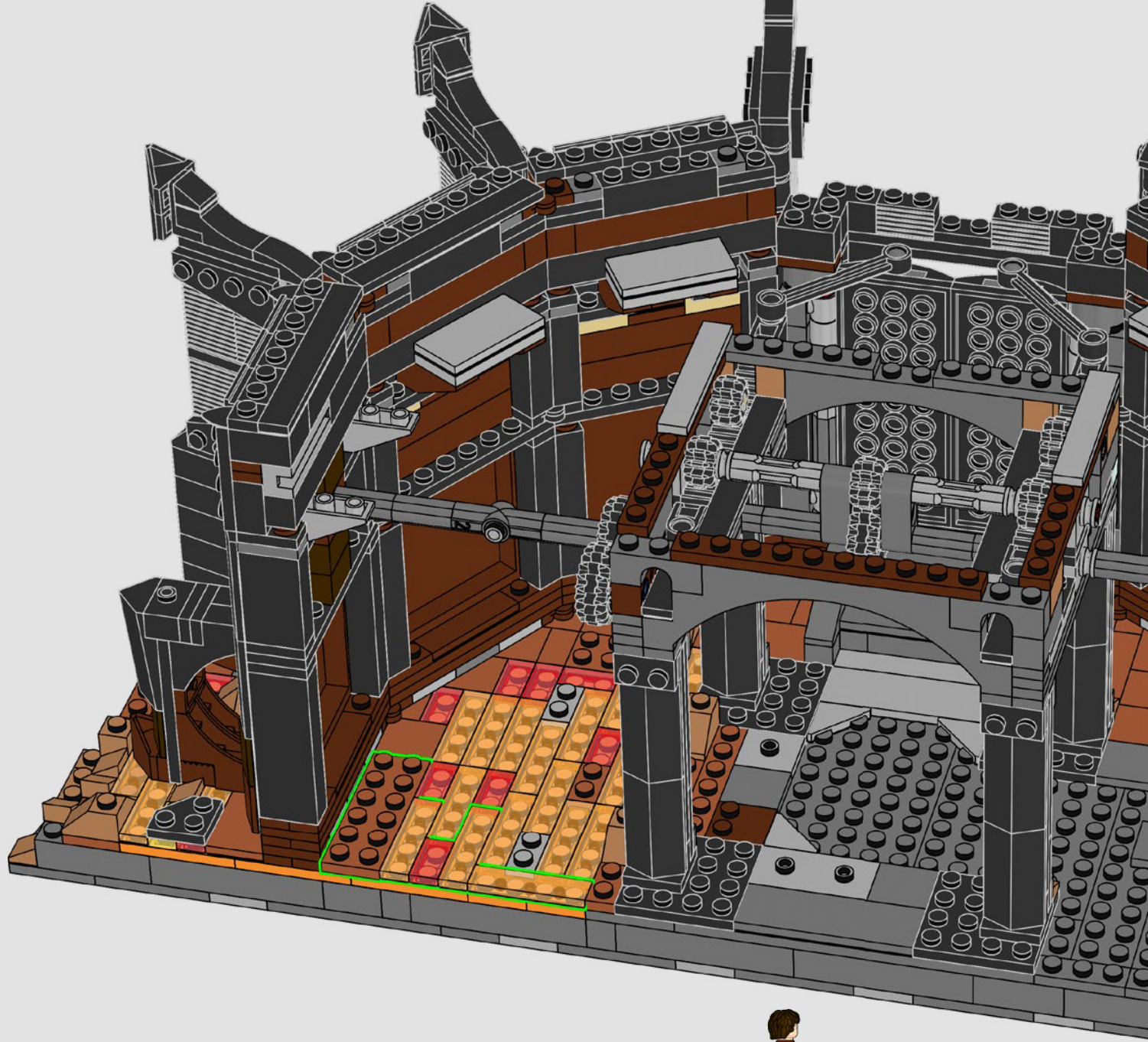



392



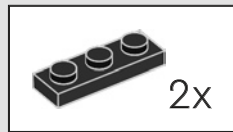
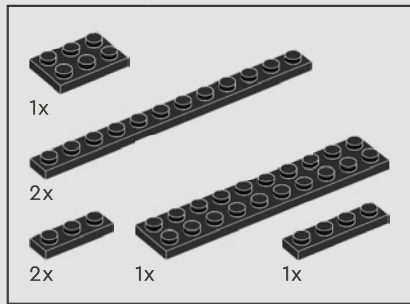

393

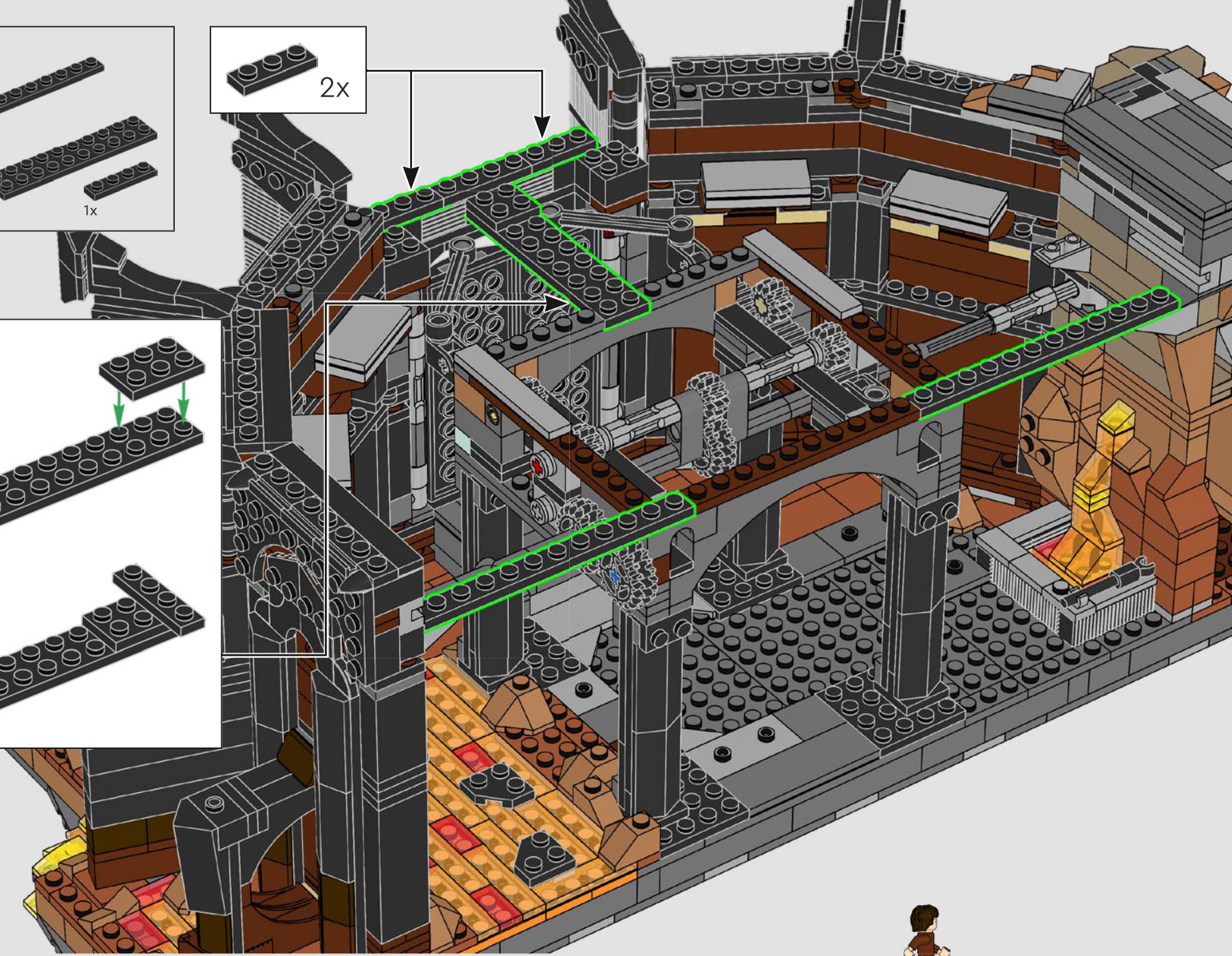
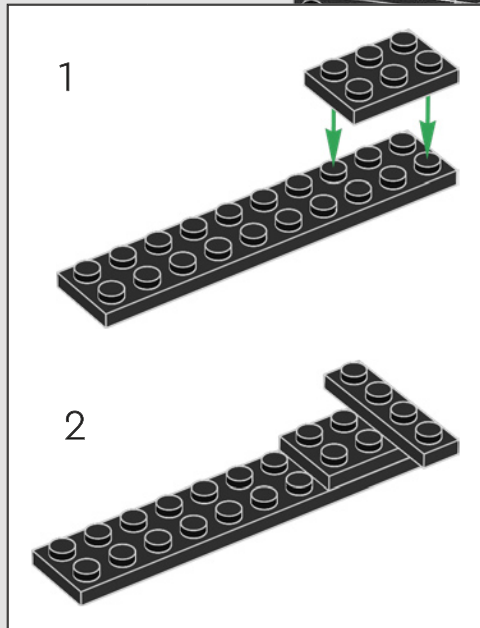

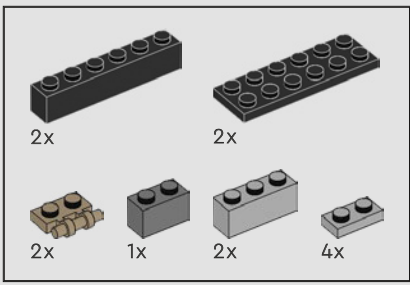

394 1

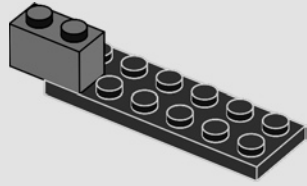

3

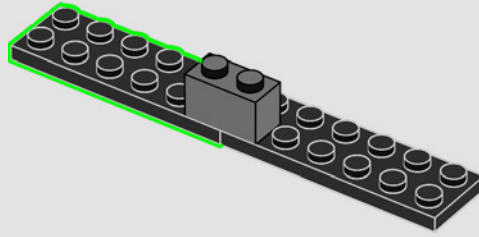

2

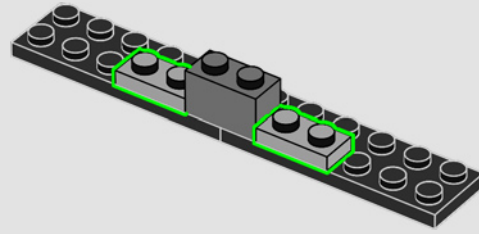

4

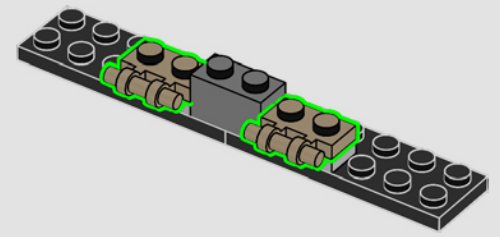

5

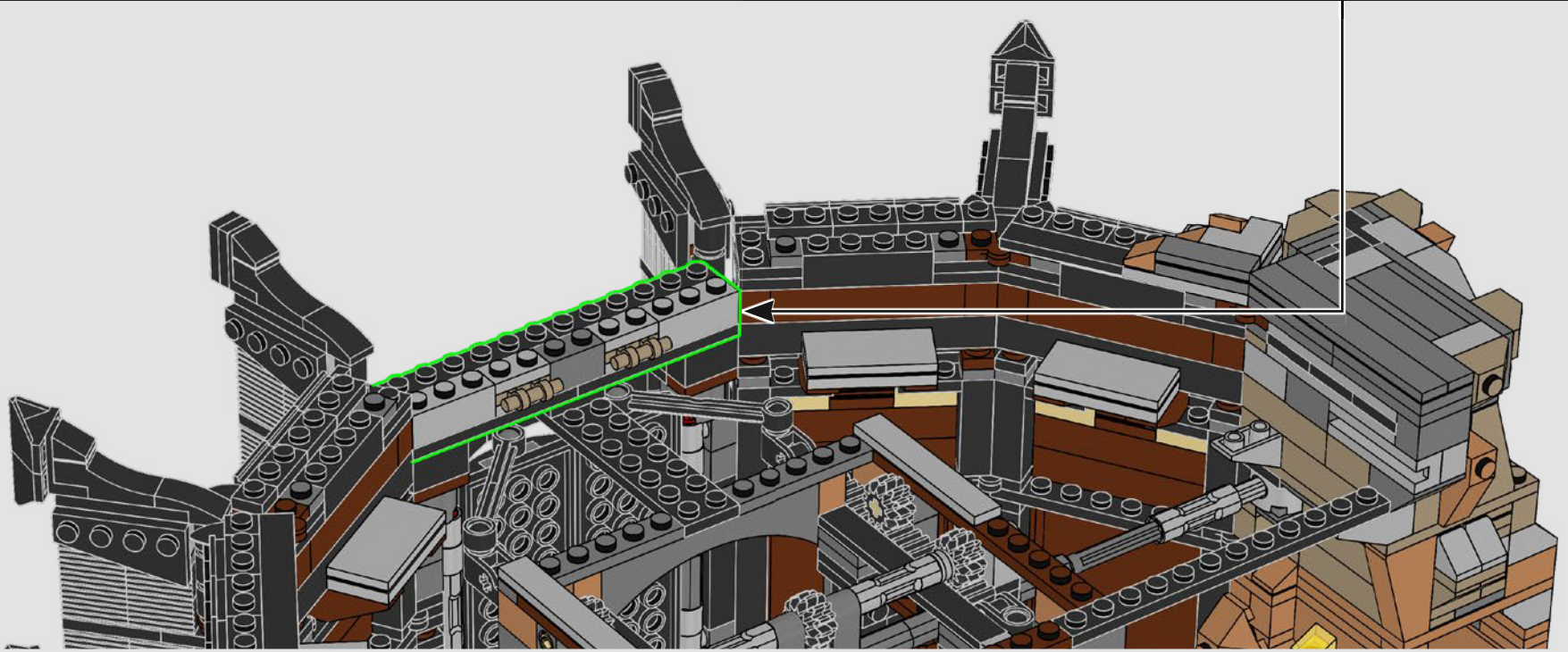
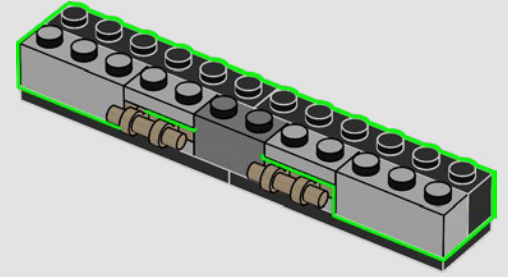

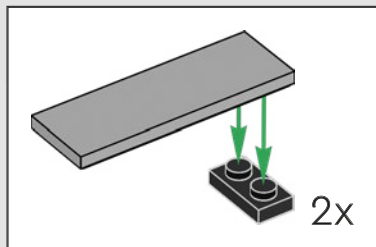
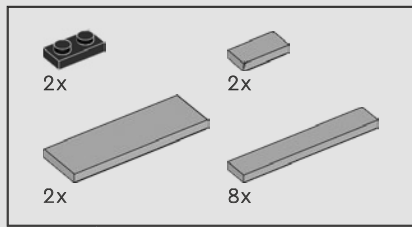

395

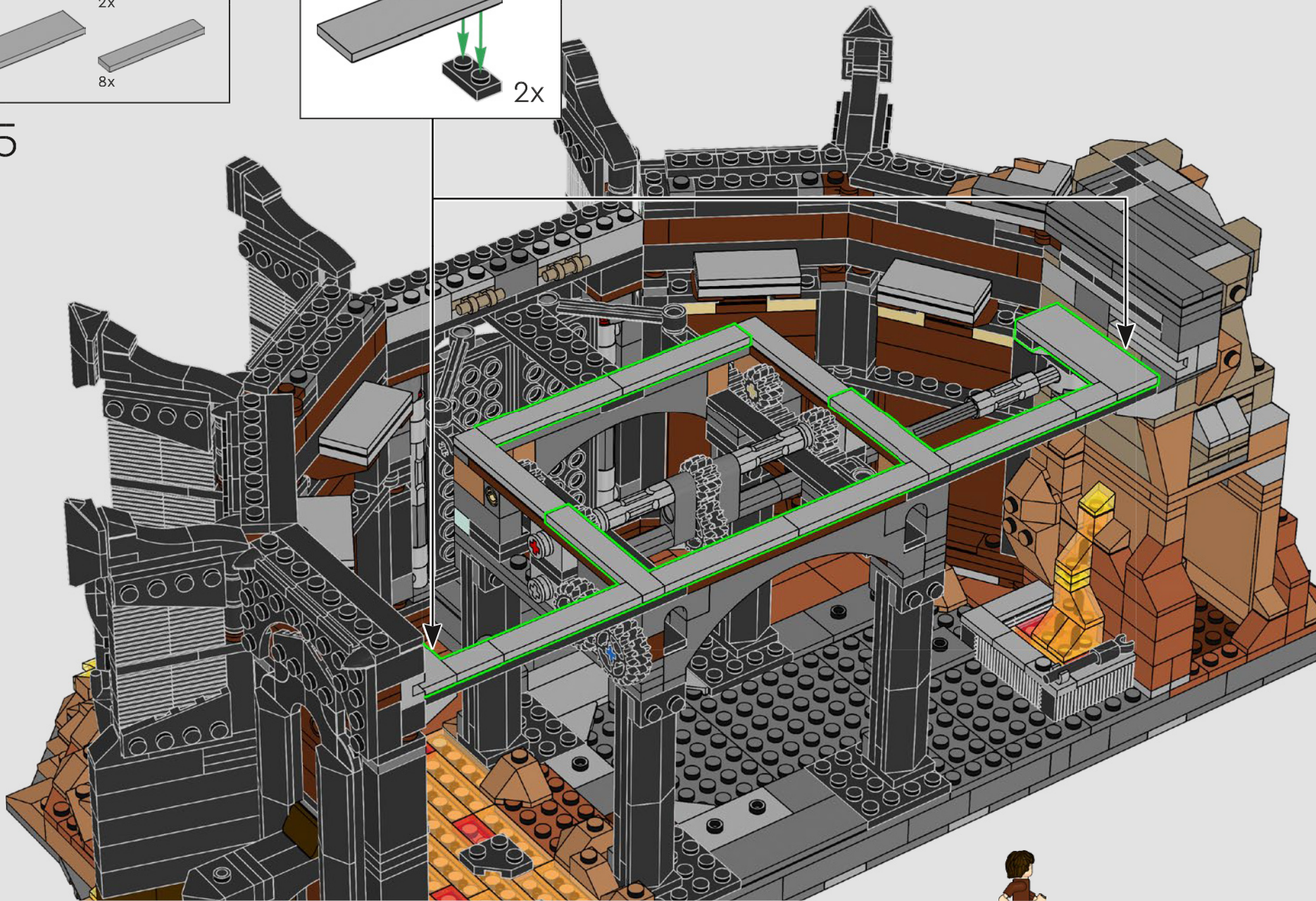

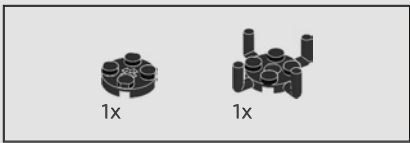

396

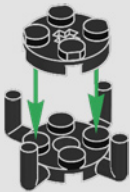

397

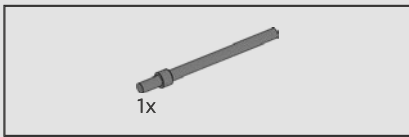

398

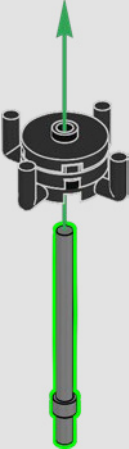

399

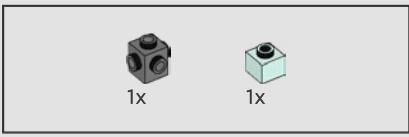
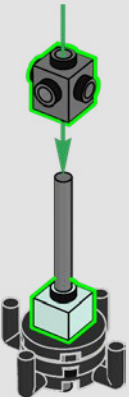

400

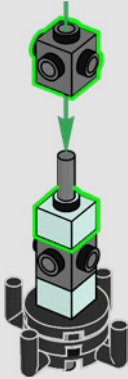

401

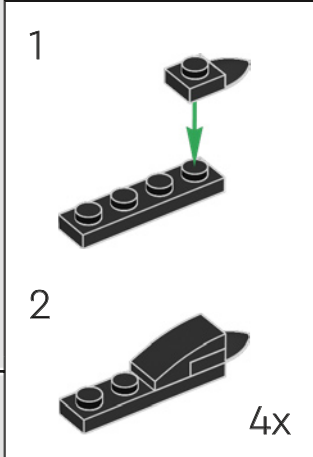
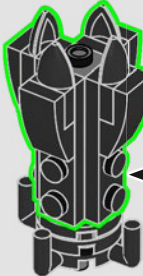

402

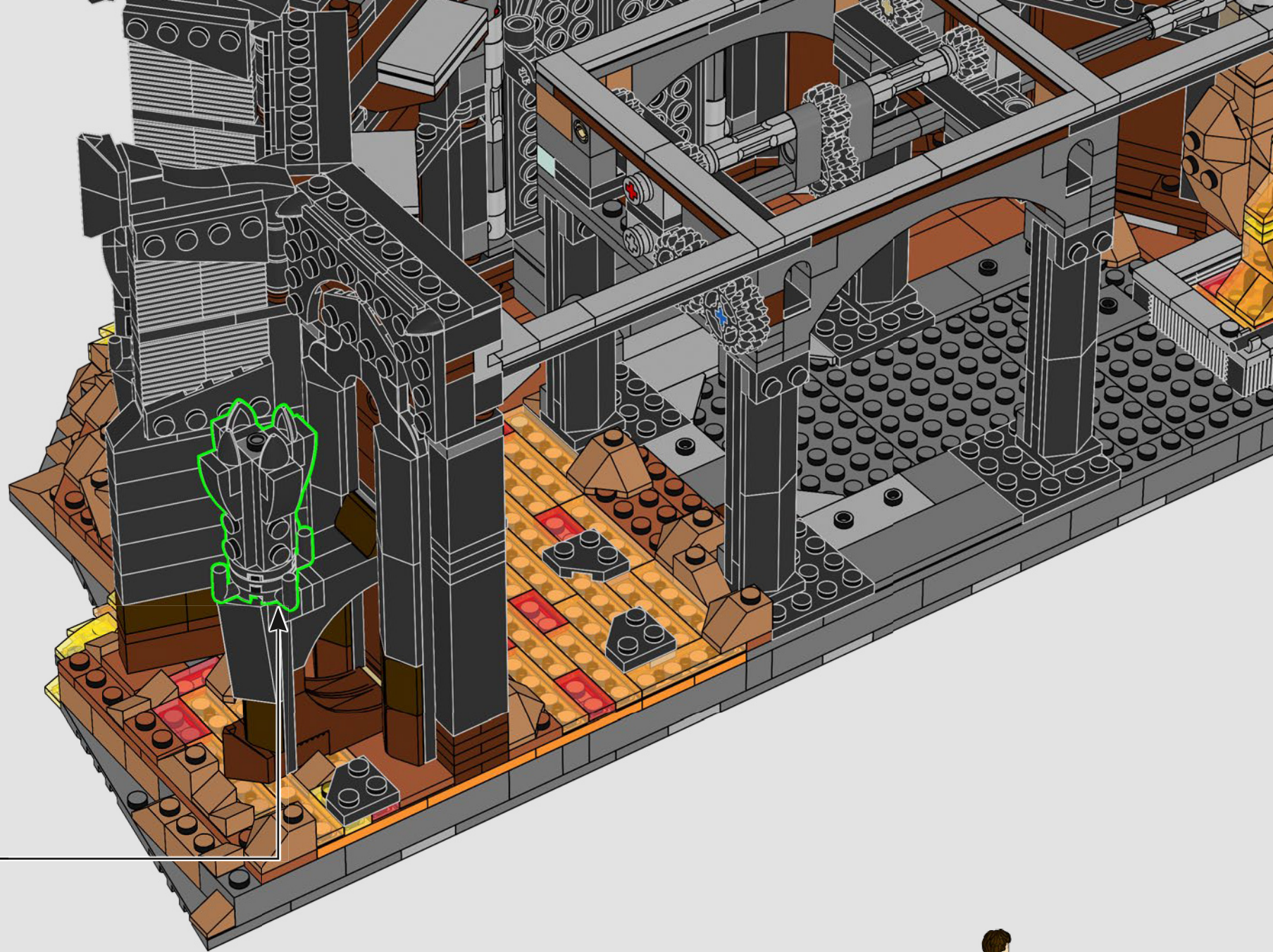



Für dieses Modell wurde eine brandneue Serie von Helmen in vier verschiedenen Designs erschaffen.

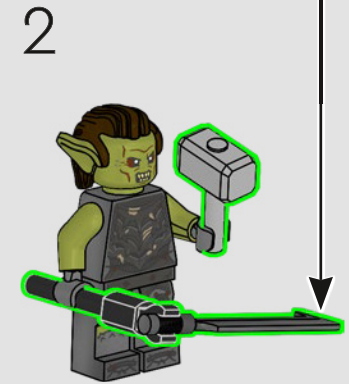
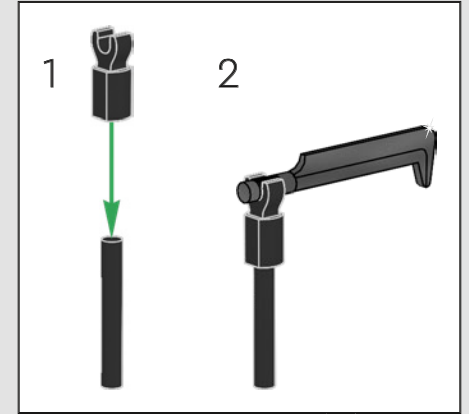
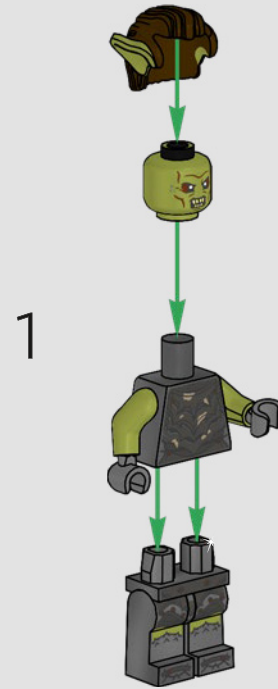
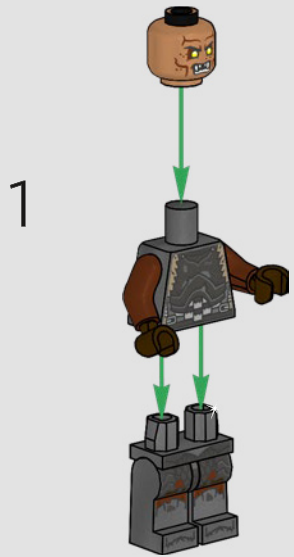

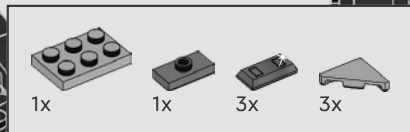

403

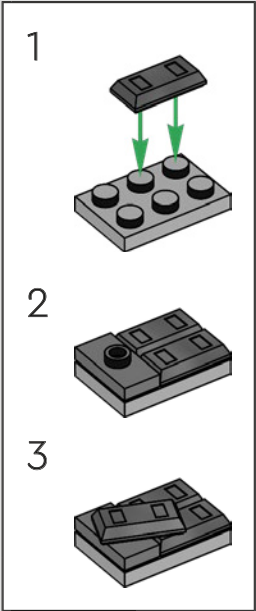
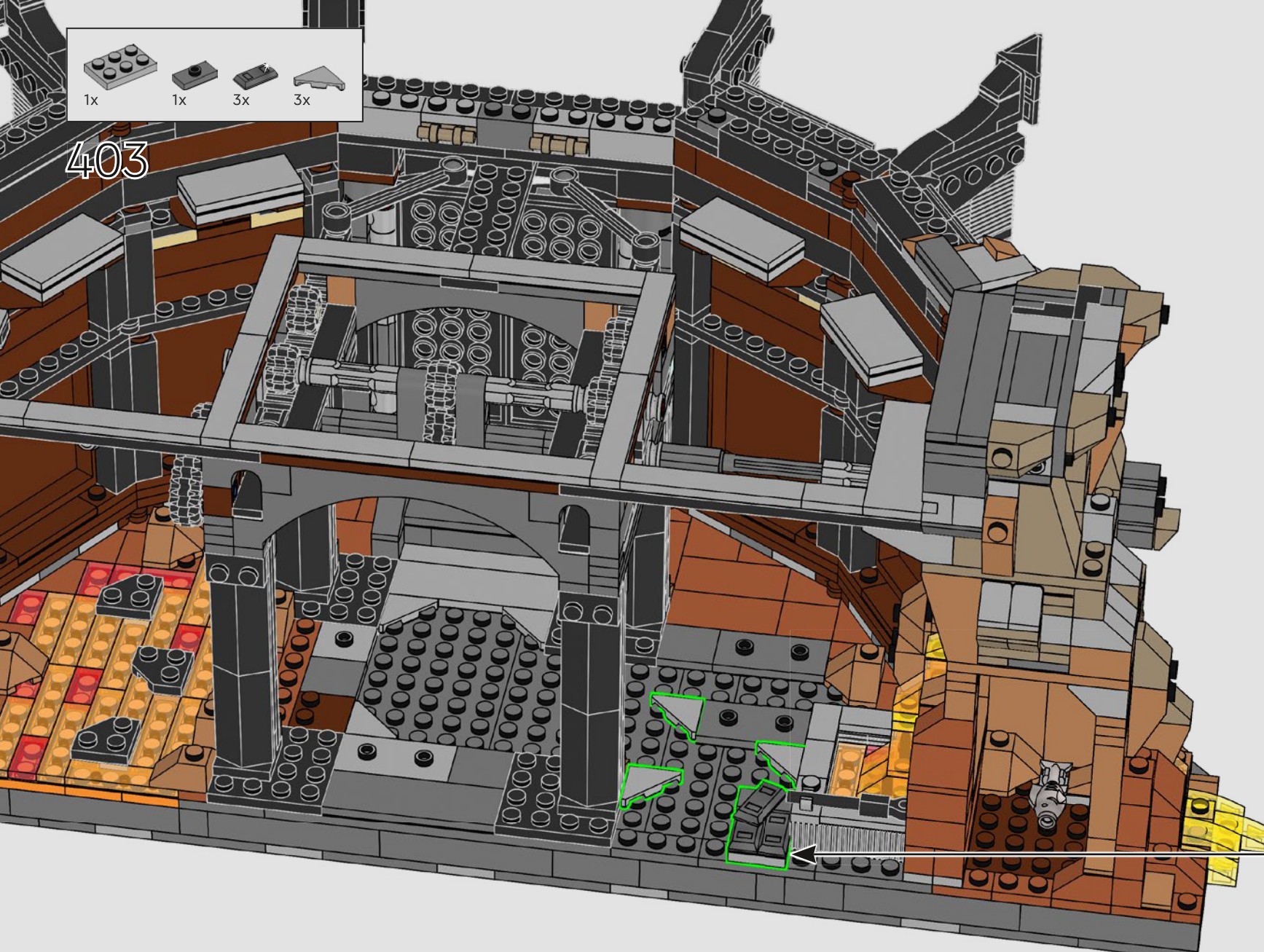

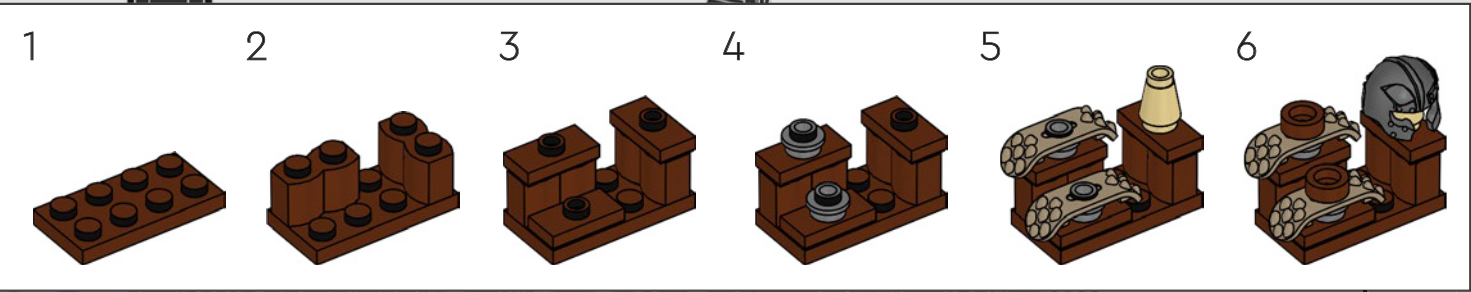
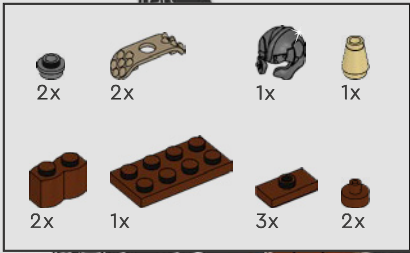

404



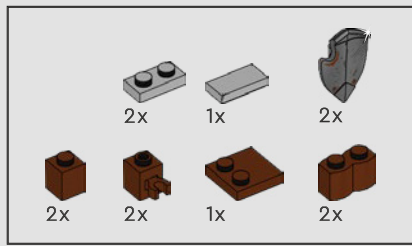

405

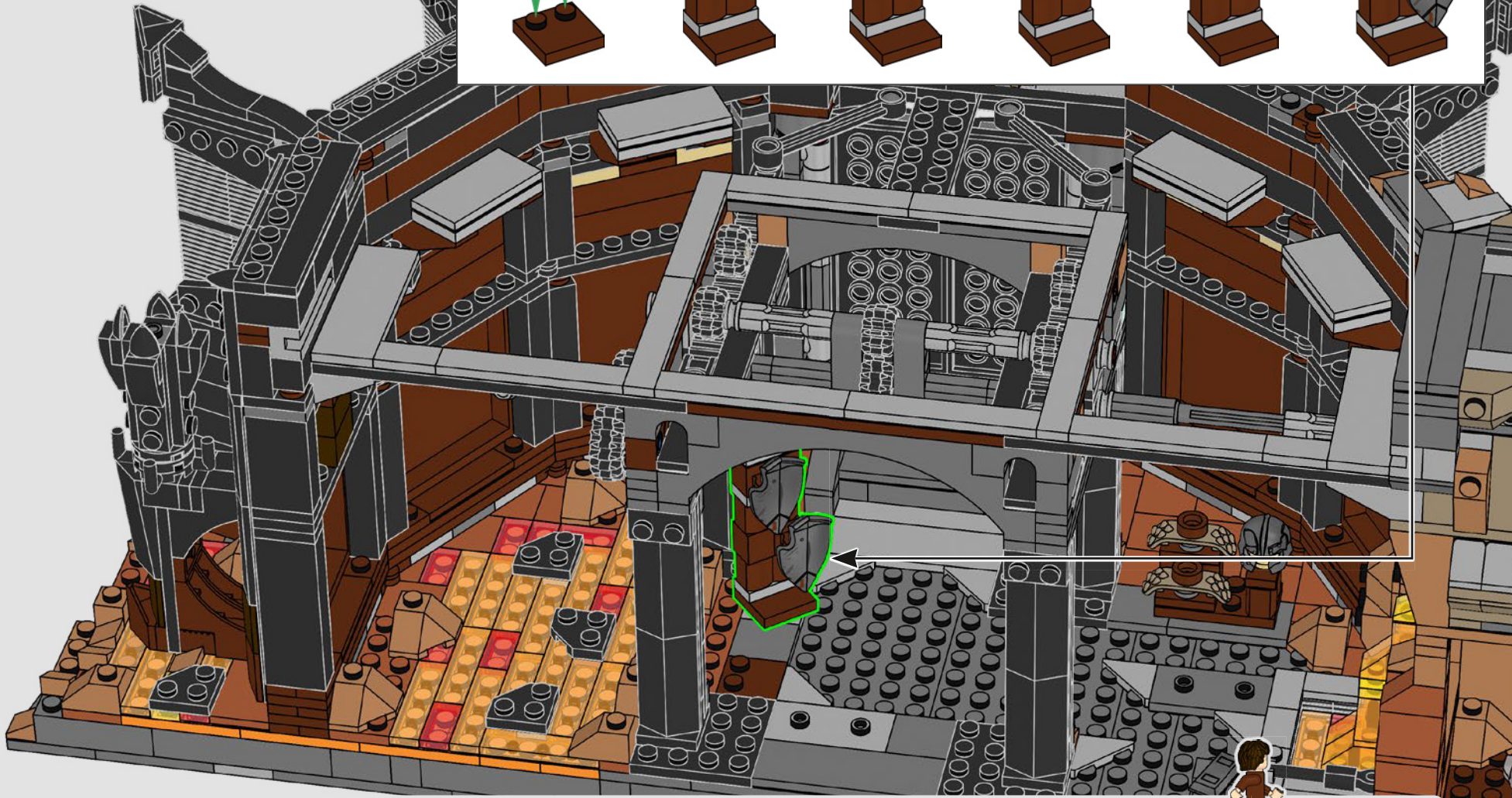
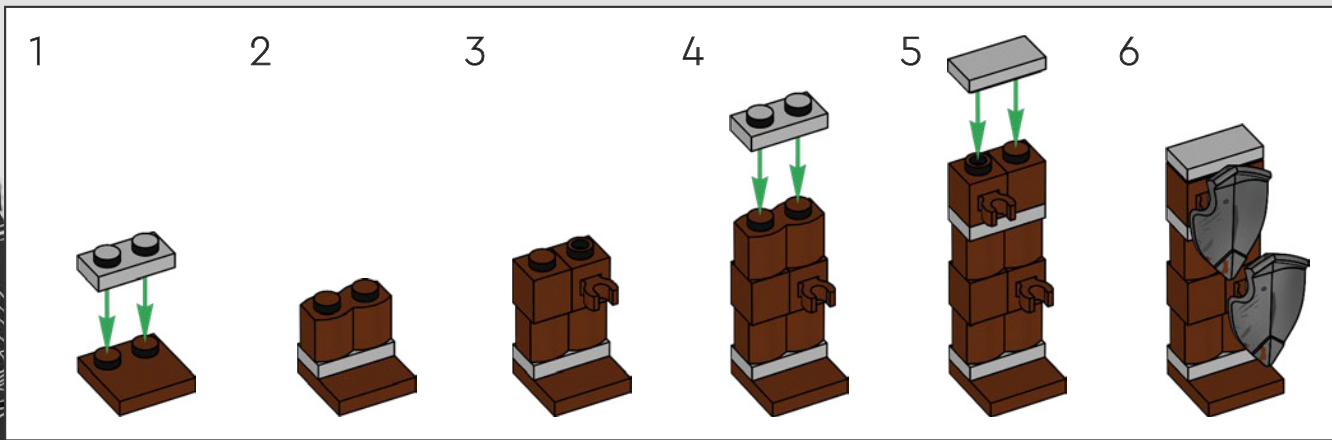

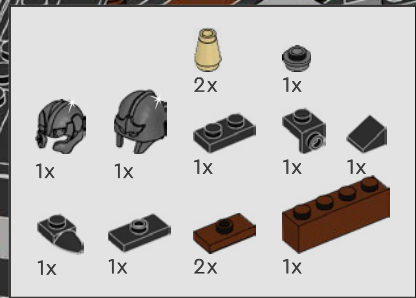

406

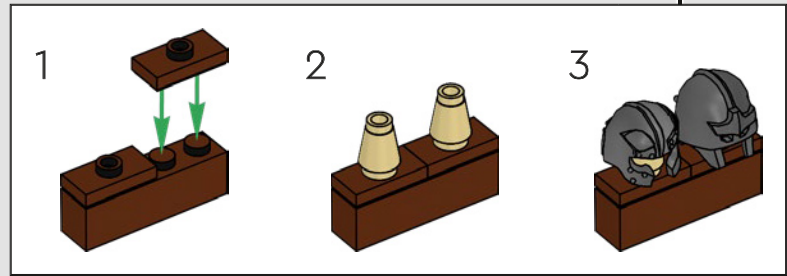
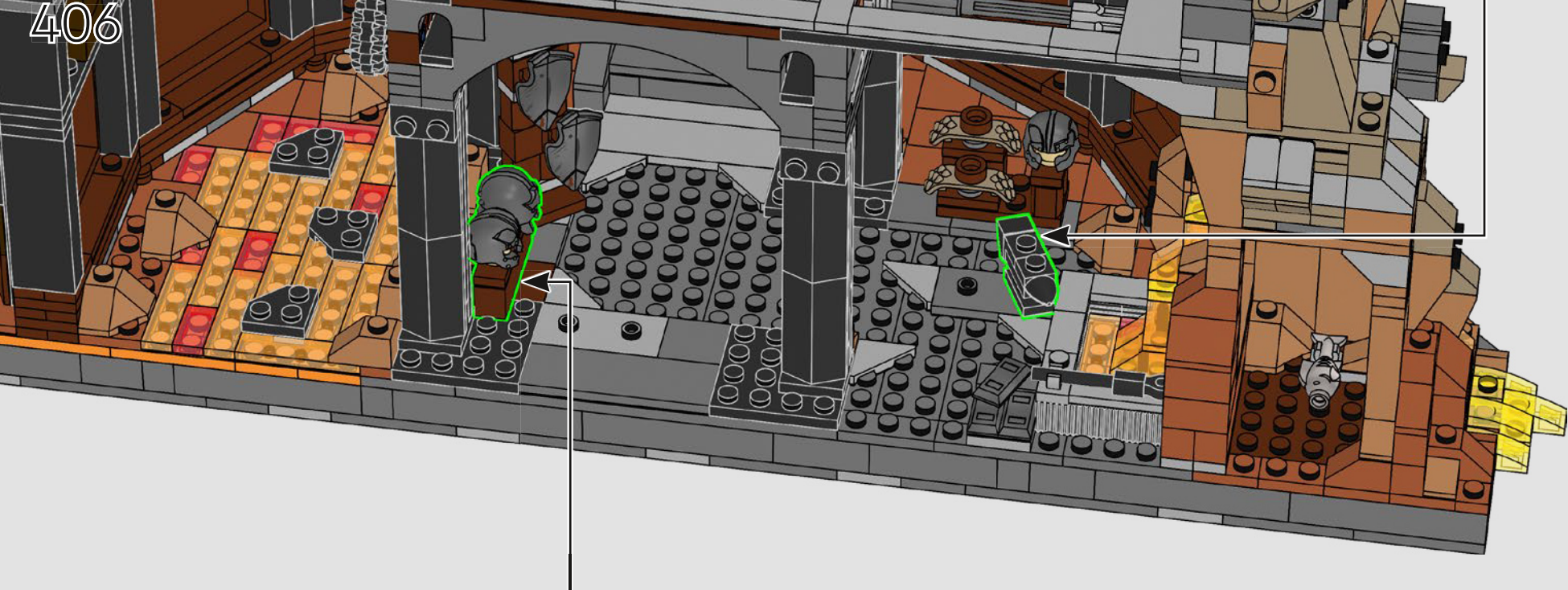
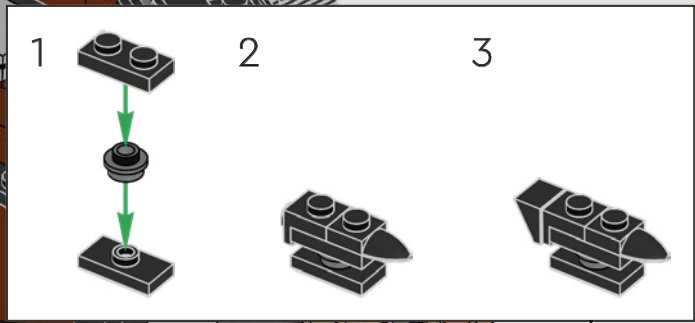

Um unerkannt durch Mordor™ zu reisen, haben sich Frodo Beutlin und Samweis Gamschie mit diesen Helmen als Orks verkleidet.



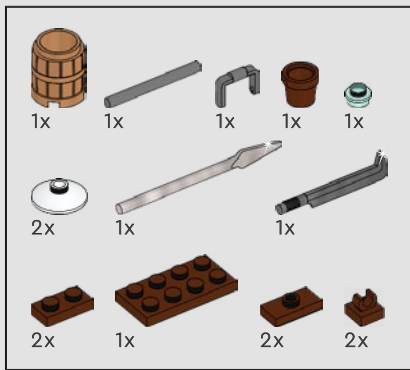

407

1



2

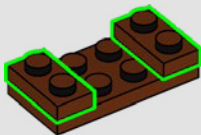

3

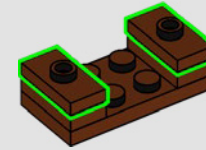

4

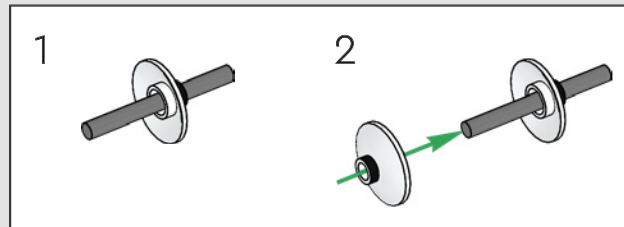
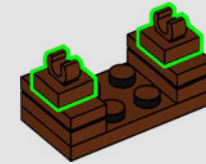

5

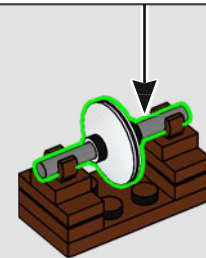

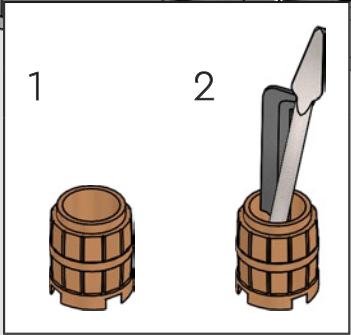
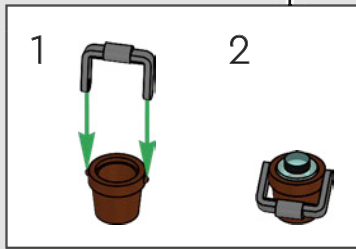
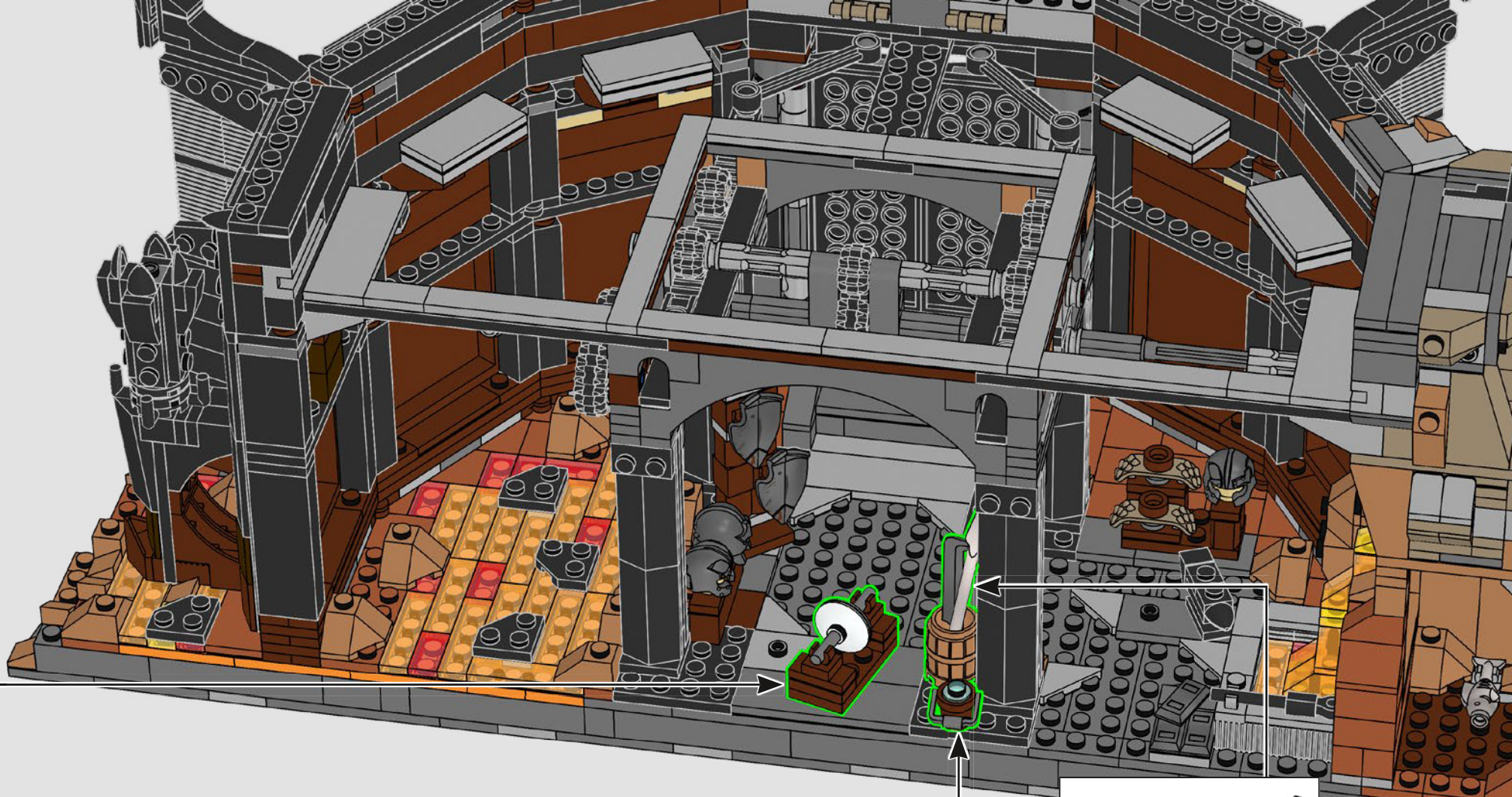

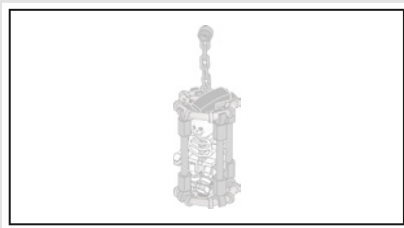

408



409

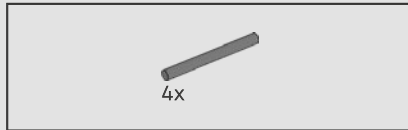
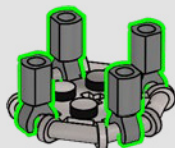

410

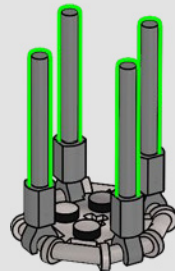

411

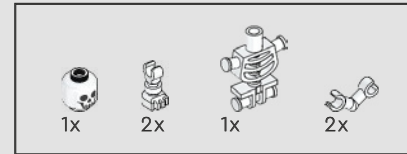
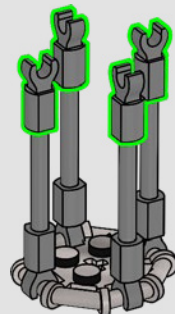

412

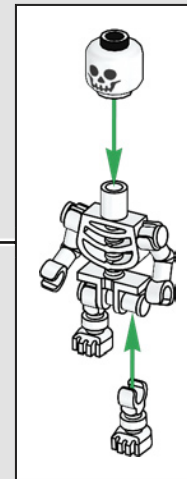
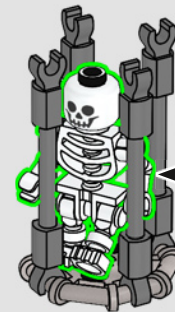

413

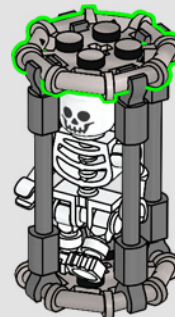

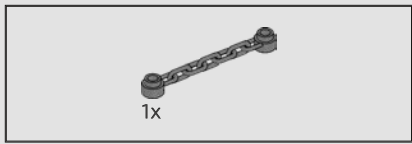

414

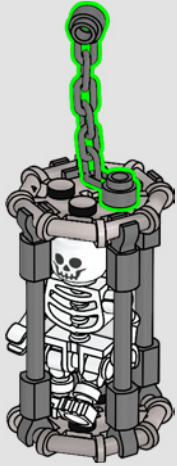

415

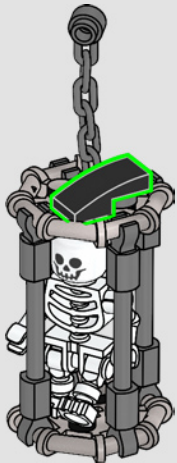

416

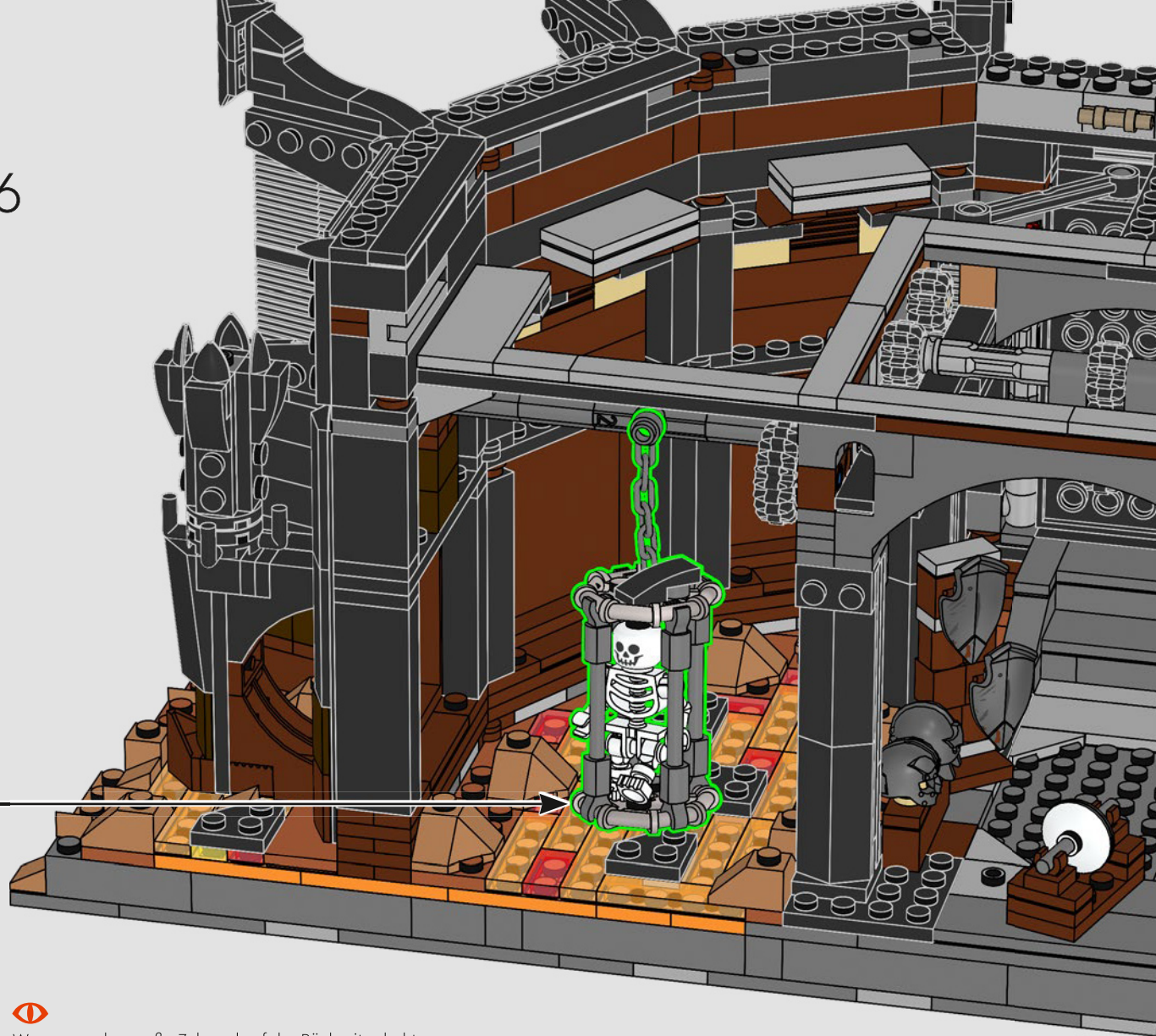

Wenn man das große Zahnrad auf der Rückseite dreht, wird der Käfig herabgelassen, der gefährlich über der Lavagrube baumelt.



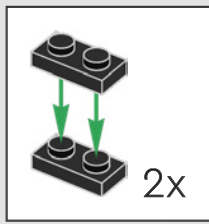
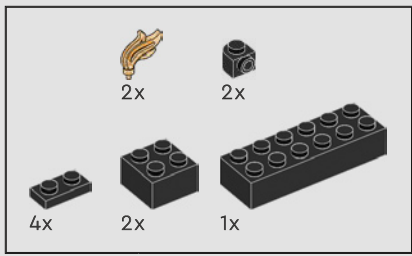

417

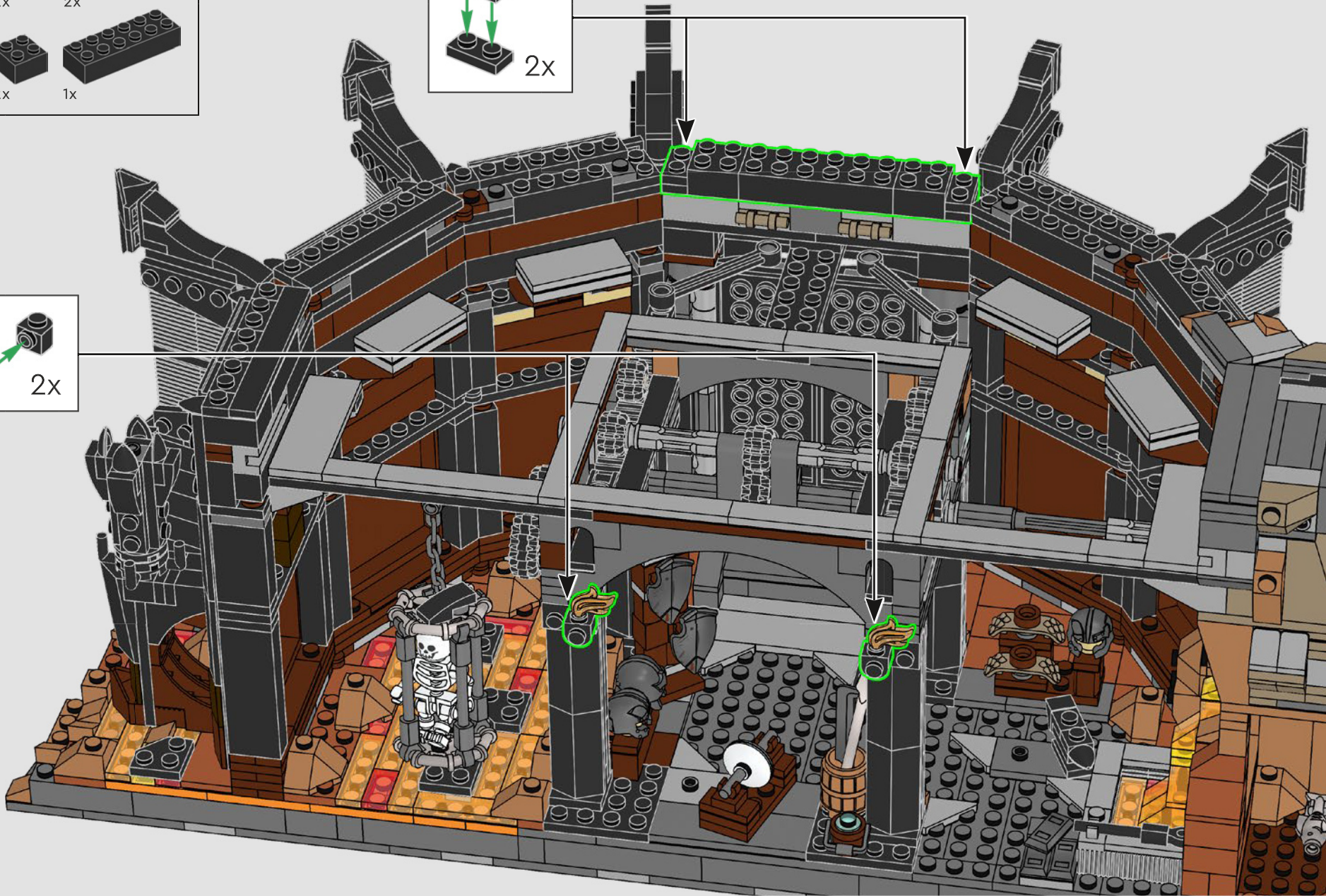
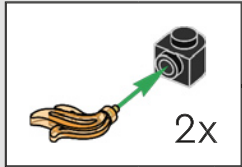

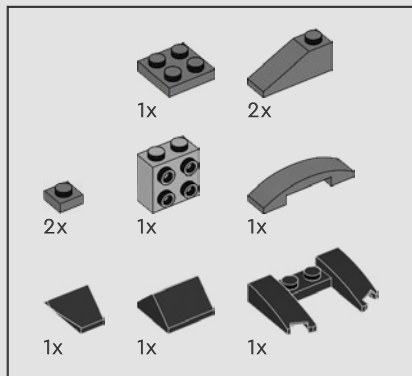

418

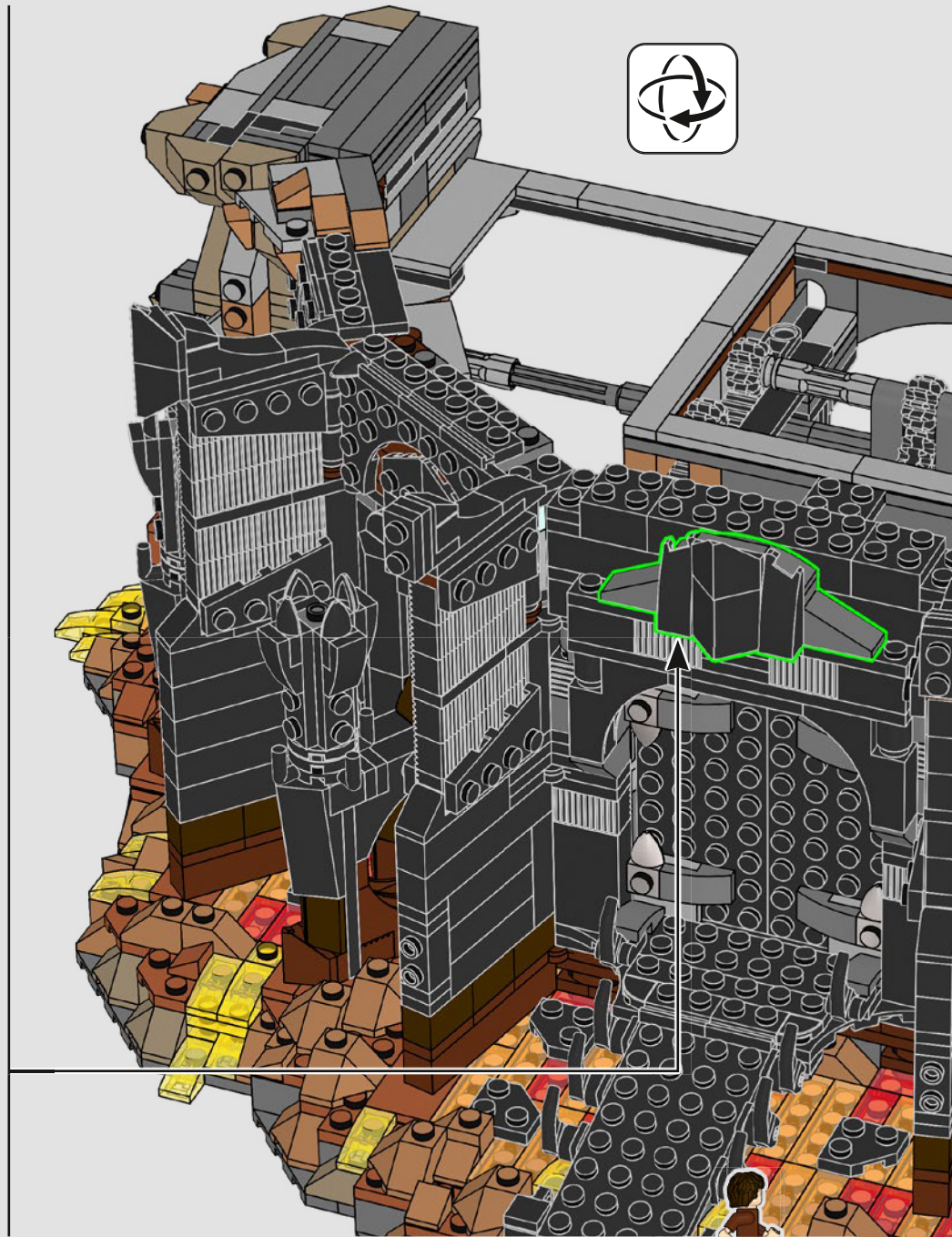
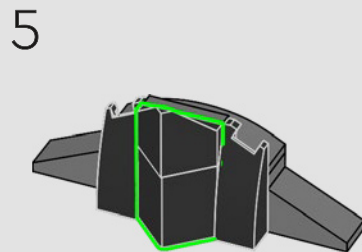
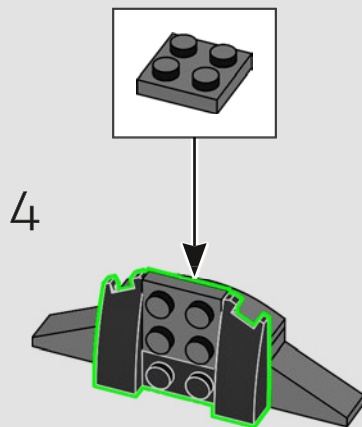
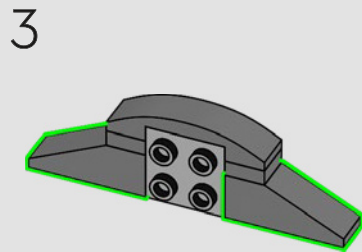
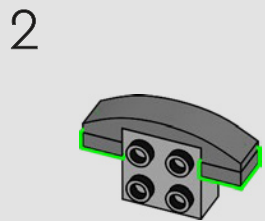
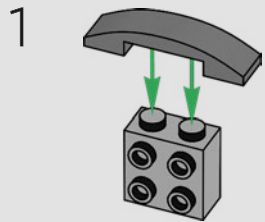

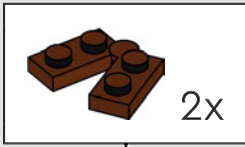

419

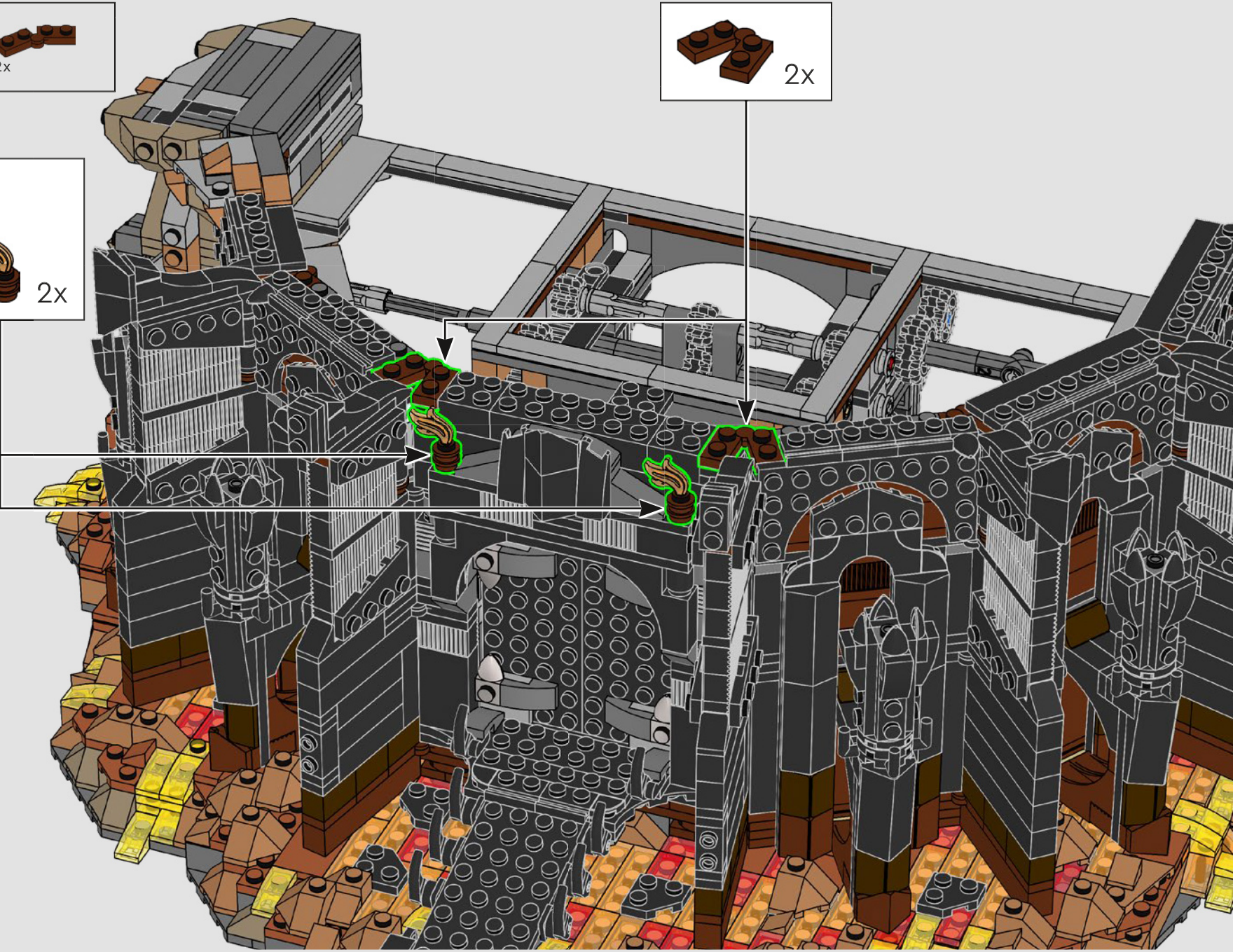
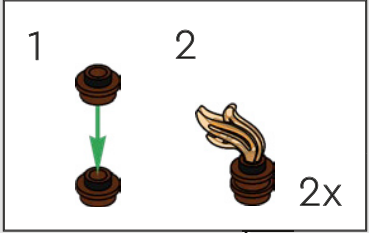

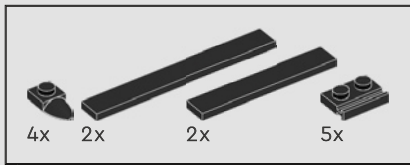

420

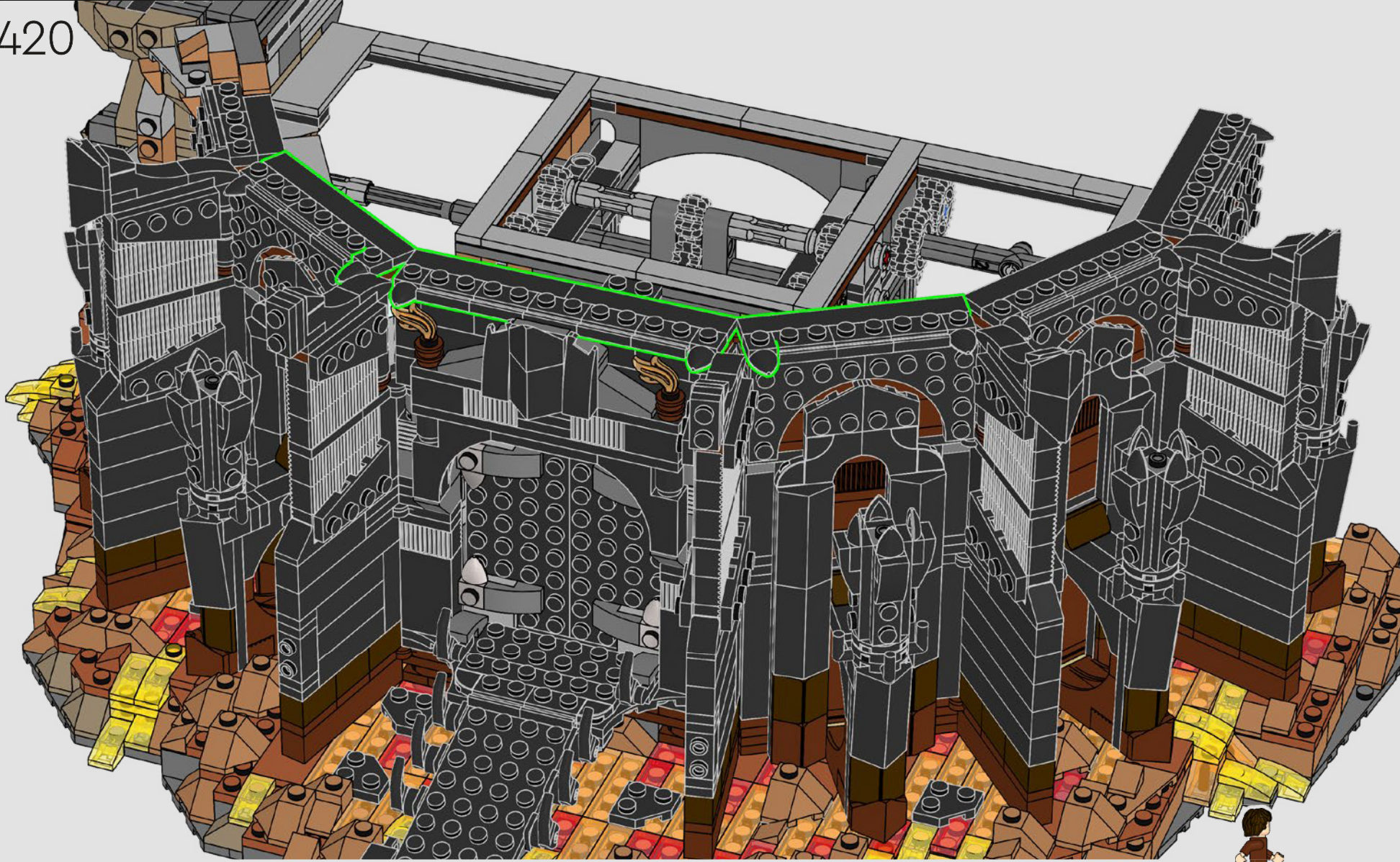

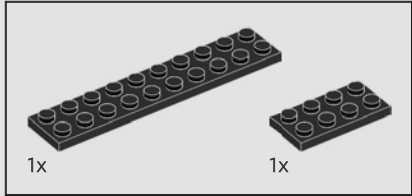
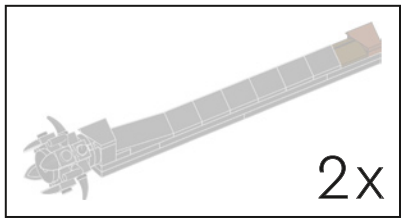

421

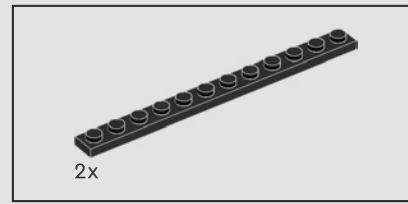
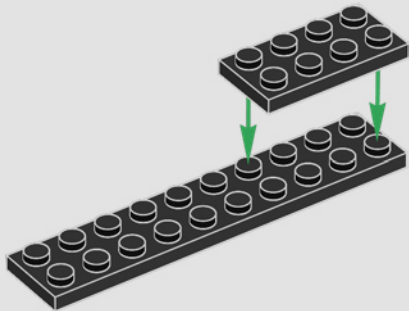

422

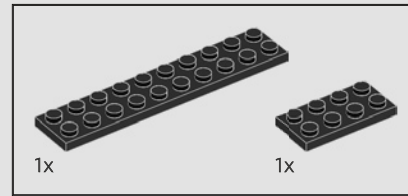
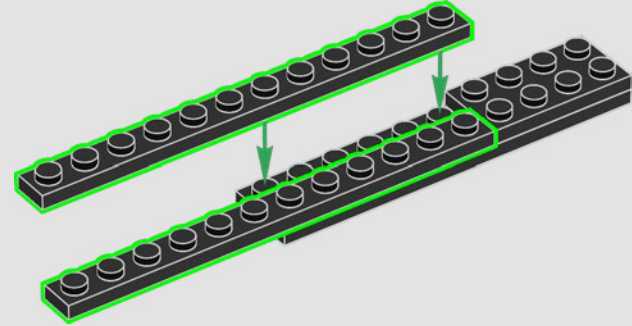

423

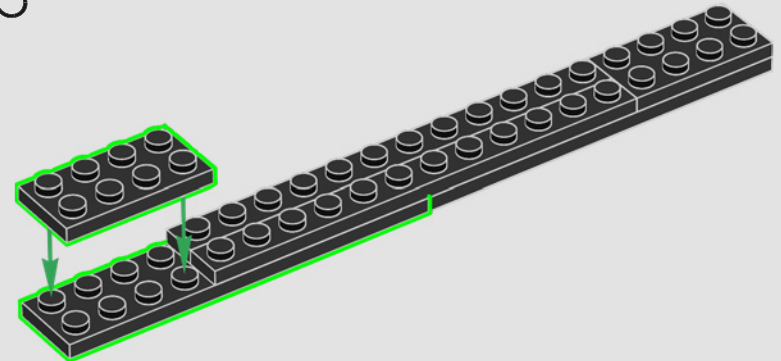

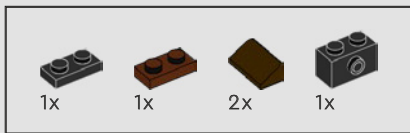

424

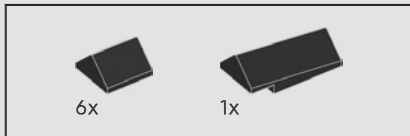
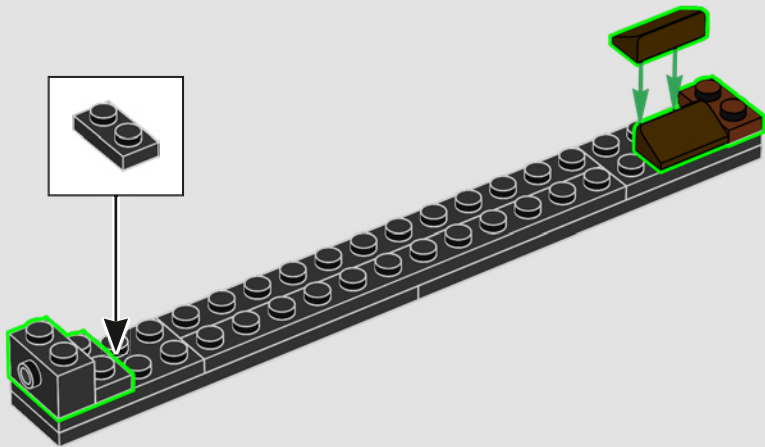

425

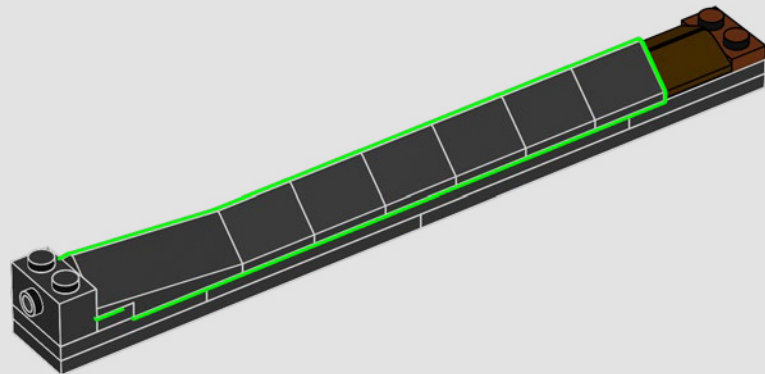

426

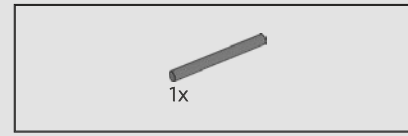
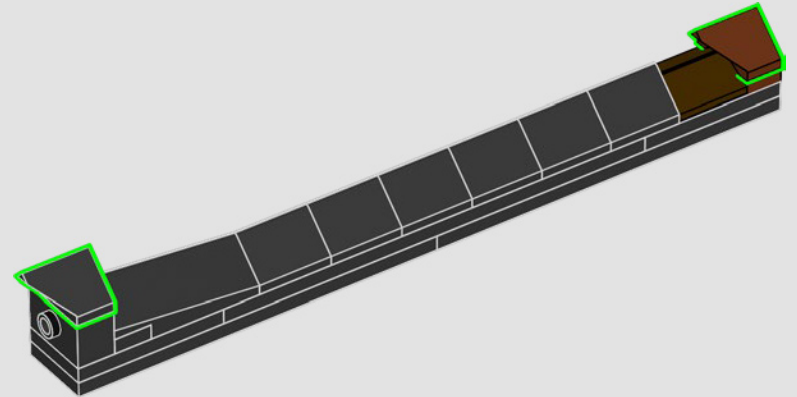

427

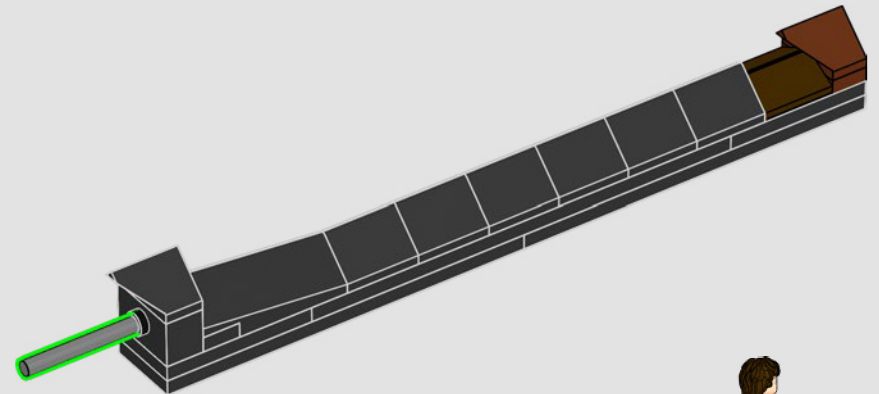

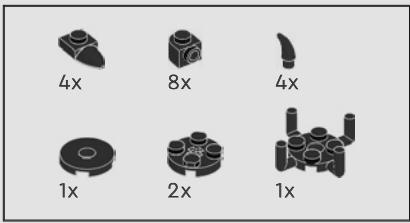

428

1



3

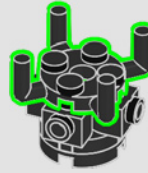

5

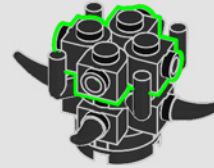

2

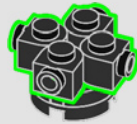

4



6

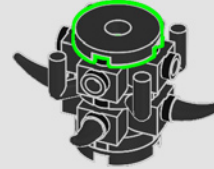

7

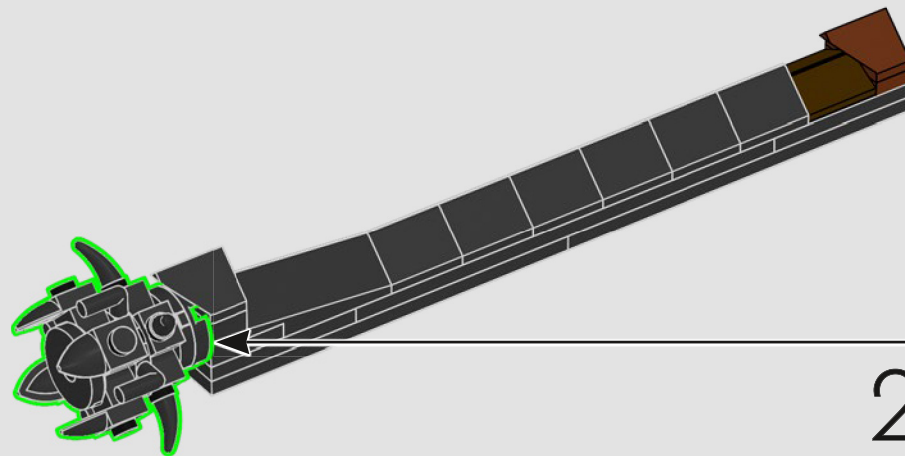

2x

429

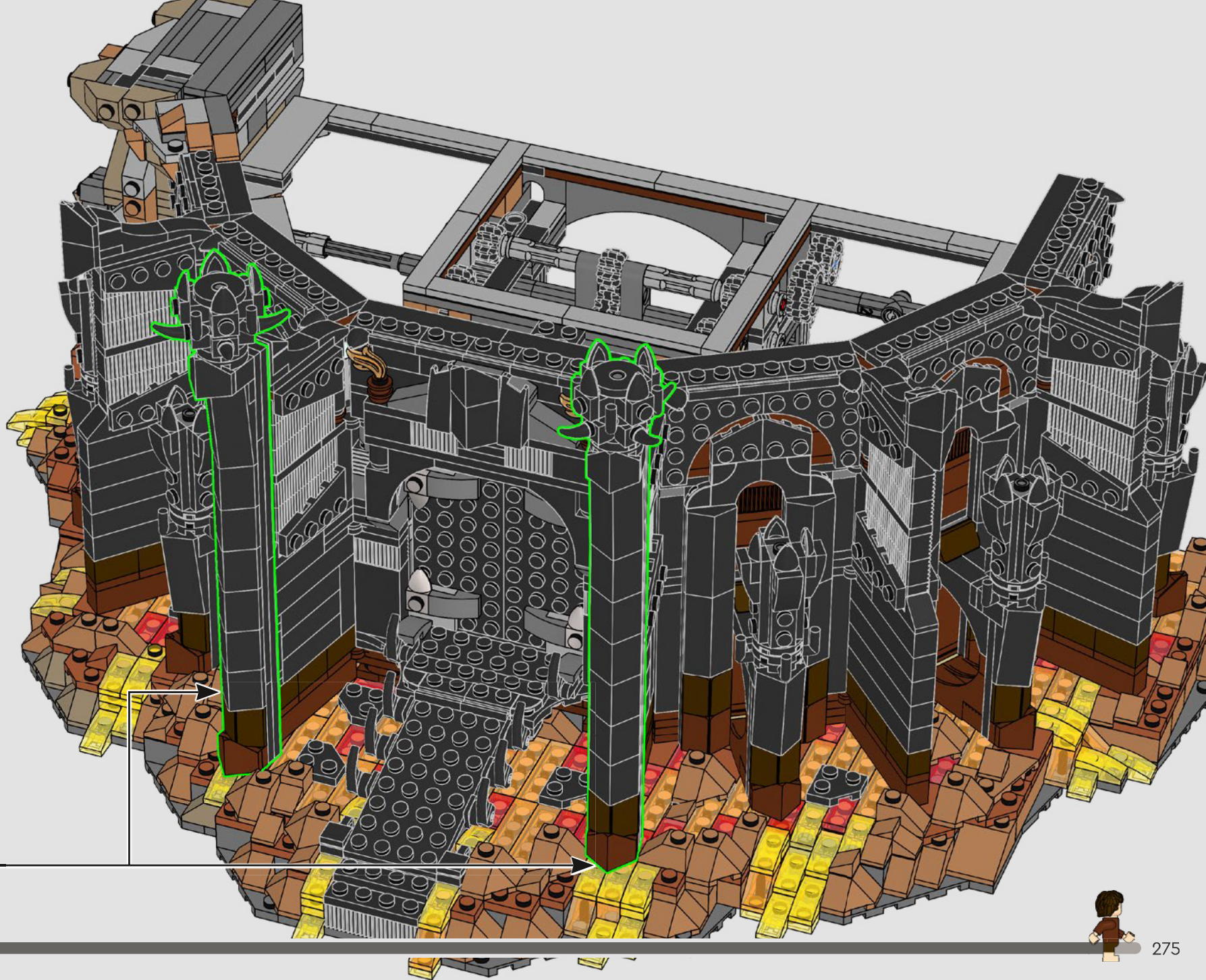

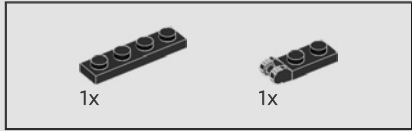
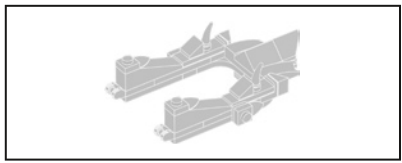

430

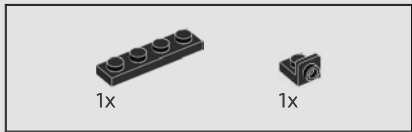
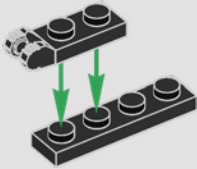

431

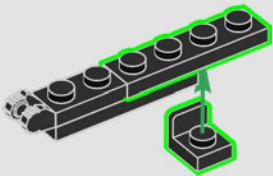

432

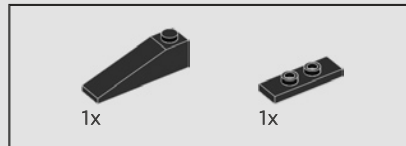
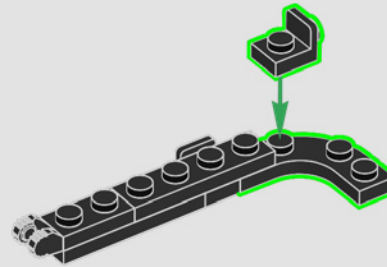

433

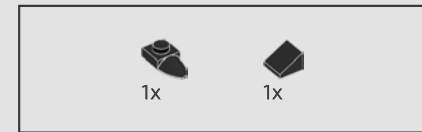
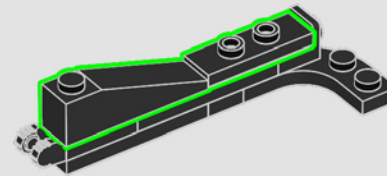

434

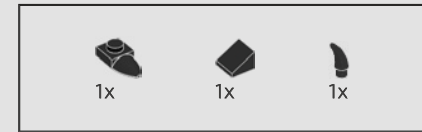
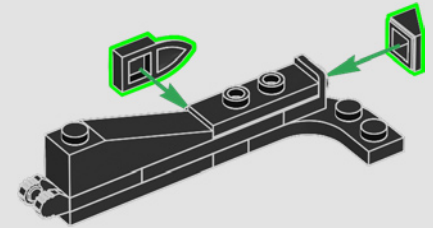

435

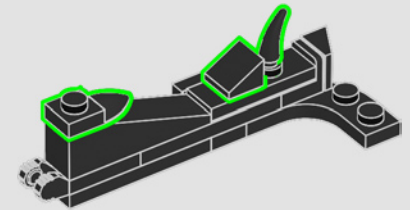

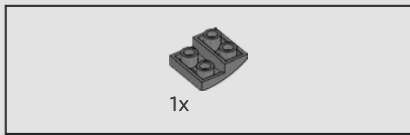

1x

436

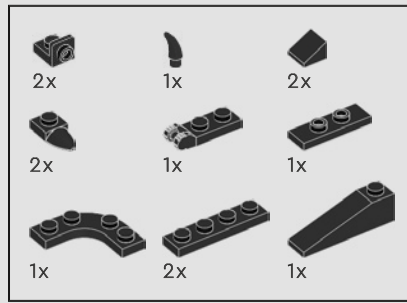
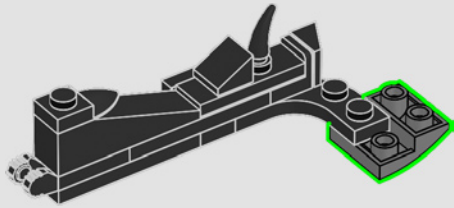

437

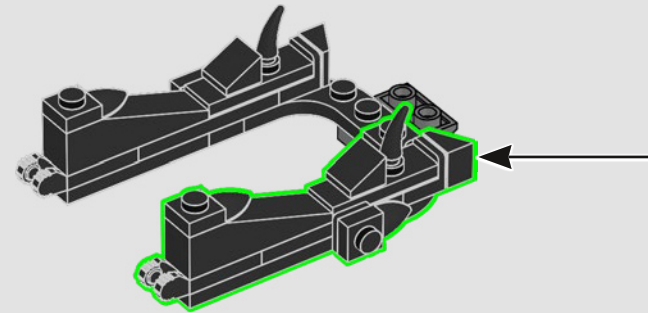
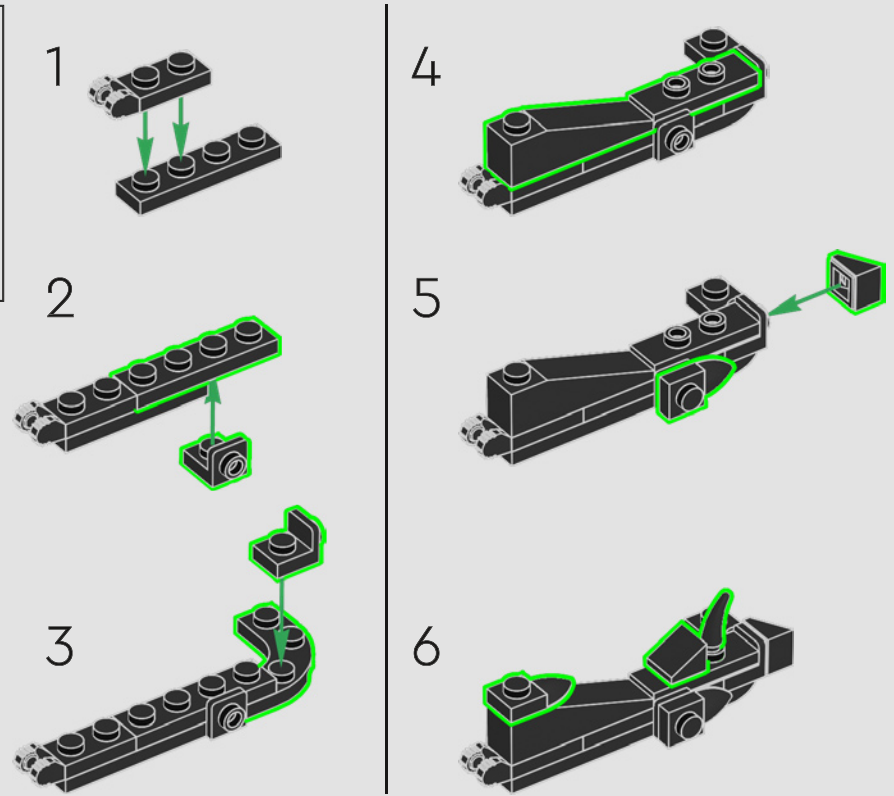

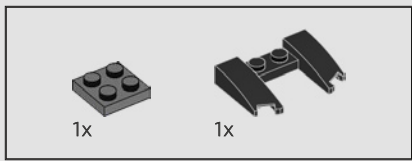

438

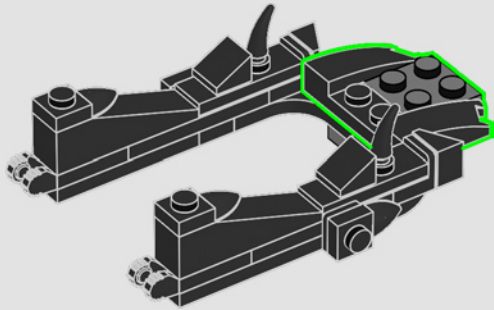

439

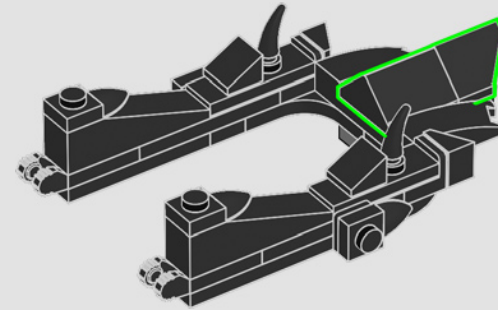

440

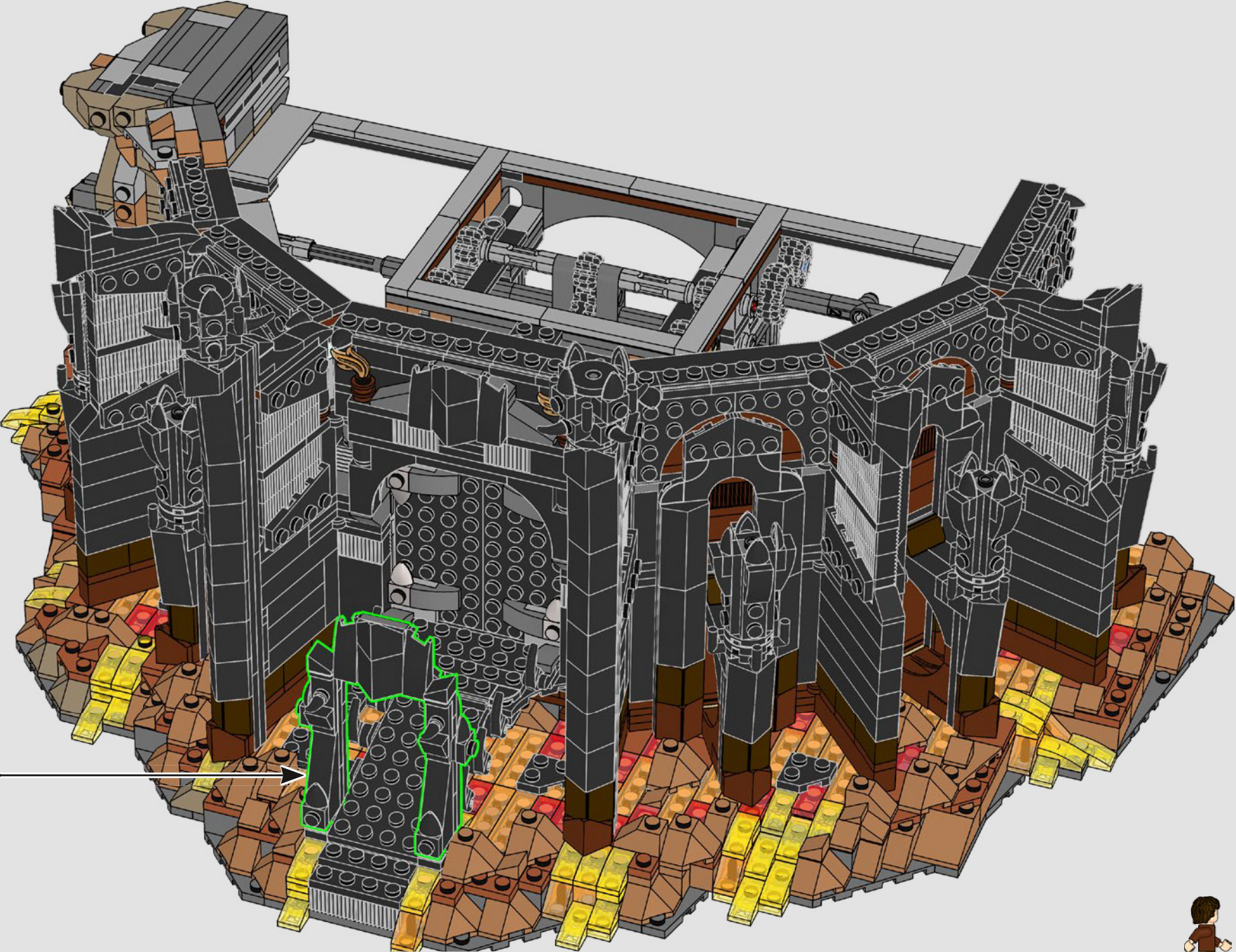



LEGO and the LEGO logo are trademarks of the LEGO Group. ©2024 The LEGO Group.



© New Line Productions Inc. All rights reserved.
THE LORD OF THE RINGS TRILOGY and all names
of the characters, items, events, and places therein
are ™ of Middle-earth Enterprises, LLC under license
to New Line Productions, Inc. (s24)